

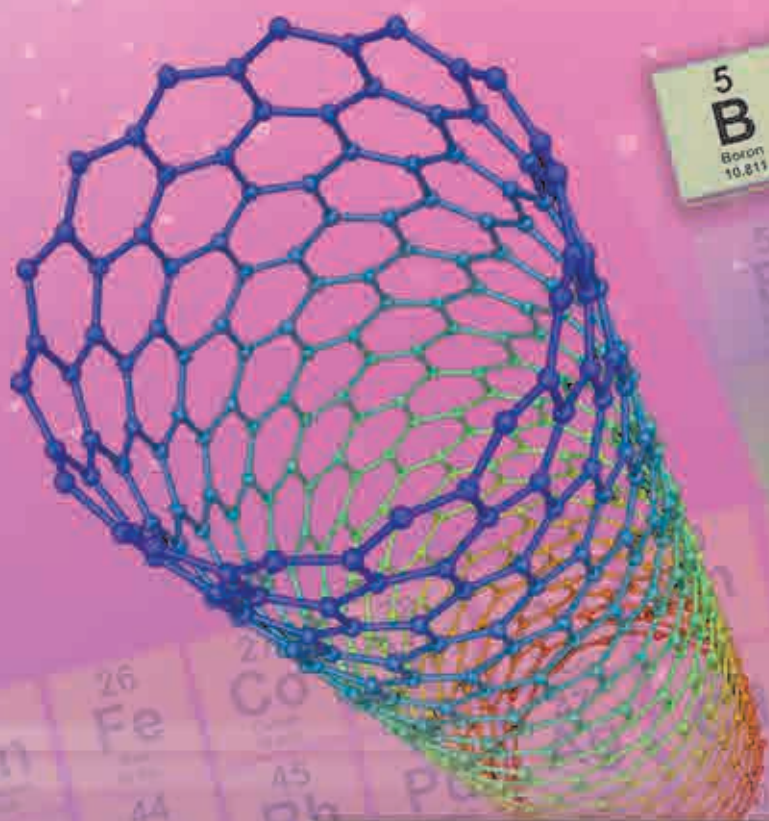

CHEMISTRY

Standard XI



5 B Boron 10.811	6 C Carbon 12.011	7 N Nitrogen 14.007	8 O Oxygen 15.999	9 F Fluorine 18.998	10 Ne Neon 20.180
	14 Si Silicon 28.086	15 P Phosphorus 30.974	16 S Sulfur 32.066	17 Cl Chlorine 35.453	18 Ar Argon 39.948
	32 Ge Germanium 72.631	33 As Arsenic 74.922	34 Se Selenium 78.971	35 Br Bromine 79.904	36 Kr Krypton 83.798

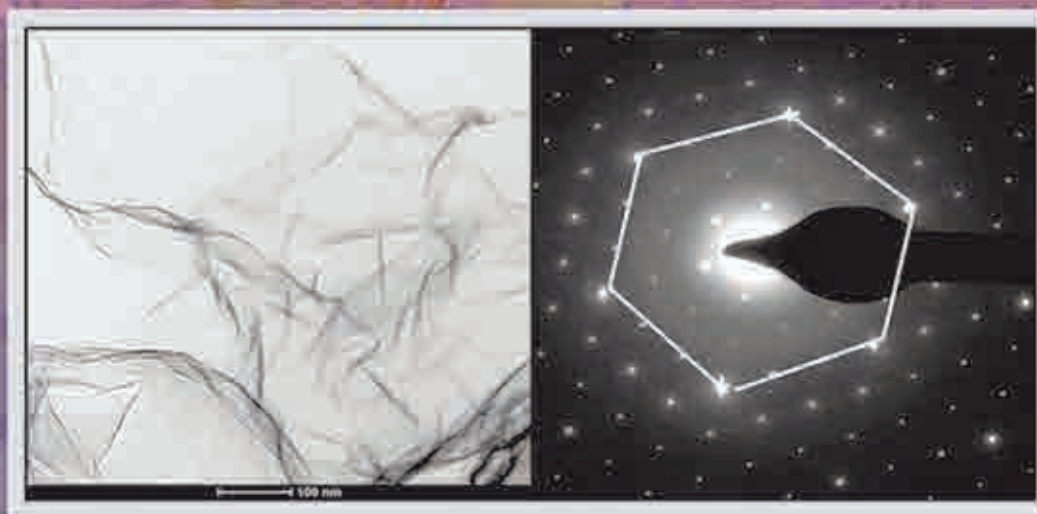

The Coordination Committee formed by GR No. Abhyas - 2116/(Pra.Kra.43/16) SD - 4 Dated 25.4.2016 has given approval to prescribe this textbook in its meeting held on 20.6.2019 and it has been decided to implement it from academic year 2019-20.

CHEMISTRY

Standard XI



Download DIKSHA App on your smartphone. If you scan the Q.R. Code on this page of your textbook, you will be able to access full text. If you scan the Q.R. Code provided, you will be able to access audio-visual study material relevant to each lesson, provided as teaching and learning aids.



2019

**Maharashtra State Bureau of Textbook Production and
Curriculum Research, Pune.**

First Edition :
2019

© **Maharashtra State Bureau of Textbook Production and Curriculum Research, Pune - 411 004.**

The Maharashtra State Bureau of Textbook Production and Curriculum Research reserves all rights relating to the book. No part of this book should be reproduced without the written permission of the Director, Maharashtra State Bureau of Textbook Production and Curriculum Research, 'Balbharati', Senapati Bapat Marg, Pune 411004.

Subject Committee

Dr. Chandrashekhar V. Murumkar, **Chairman**
Dr. Sushama Dilip Joag, Member
Dr. Shridhar Pandurang Gejji, Member
Dr. Satyawati Sudhir Joshi, Member
Dr. Rajashree Vikas Kashalkar, Member
Dr. Laxman Shamrao Patil, Member
Shri. Rajesh Vamanrao Roman, Member
Shri. Rajiv Arun Patole, **Member Secretary**

Study group

Dr. Anjali Deepak Ruikar
Shri. Sachin Ashok Bartakke
Smt. Archana Sanjeev Kale
Smt. Pushpalata Babanrao Gangarde
Smt. Archana Dipak Harimkar
Shri. Vishnu Rustumrao Deshmukh
Shri. Sharad Ajabrao Mankar
Shri. Ritesh Vijay Bijewar
Shri. Rupesh Dinkar Thakur
Shri. Milind Chandrakant Gaikwad
Shri. Gajanan Shivajirao Suryawanshi

Smt. Prachi Ravindra Sathe
Chief Co-ordinator

Illustration

Shri. Pradeep Ghodke
Shri. Shubham Chavan

Cover

Shri. Vivekanand S. Patil

Typesetting

DTP Section, Textbook Bureau, Pune

Co-ordination

Shri. Rajiv Arun Patole
Special Officer for Chemistry

Paper

70 GSM Creamwove

Print Order

Printer

Production

Shri Sachchitanand Aphale
Chief Production Officer
Shri Liladhar Atram
Production Officer

Publisher

Shri Vivek Uttam Gosavi,
Controller
Maharashtra State Textbook
Bureau, Prabhadevi,
Mumbai - 400 025



The Constitution of India

Preamble

WE, THE PEOPLE OF INDIA, having solemnly resolved to constitute India into a SOVEREIGN SOCIALIST SECULAR DEMOCRATIC REPUBLIC and to secure to all its citizens:

JUSTICE, social, economic and political;

LIBERTY of thought, expression, belief, faith and worship;

EQUALITY of status and of opportunity; and to promote among them all

FRATERNITY assuring the dignity of the individual and the unity and integrity of the Nation;

IN OUR CONSTITUENT ASSEMBLY this twenty-sixth day of November, 1949, do HEREBY ADOPT, ENACT AND GIVE TO OURSELVES THIS CONSTITUTION.

NATIONAL ANTHEM

Jana-gana-mana-adhināyaka jaya hē
Bhārata-bhāgya-vidhātā,

Panjāba-Sindhu-Gujarāta-Marāthā
Drāvida-Utkala-Banga

Vindhya-Himāchala-Yamunā-Gangā
uchchala-jaladhi-taranga

Tava subha nāmē jāgē, tava subha āsisa māgē,
gāhē tava jaya-gāthā,

Jana-gana-mangala-dāyaka jaya hē
Bhārata-bhāgya-vidhātā,

Jaya hē, Jaya hē, Jaya hē,
Jaya jaya jaya, jaya hē.

PLEDGE

India is my country. All Indians
are my brothers and sisters.

I love my country, and I am proud
of its rich and varied heritage. I shall
always strive to be worthy of it.

I shall give my parents, teachers
and all elders respect, and treat
everyone with courtesy.

To my country and my people,
I pledge my devotion. In their
well-being and prosperity alone lies
my happiness.

Preface

Dear Students,

We welcome you all to std. XI. For the first time, you are being introduced to the subject of chemistry discipline. You have already been acquainted with some of the concepts of chemistry from standard five onwards, especially in the subject of general science up to standard eight and science and technology for standard nine and ten.

Chemistry is very broad subject that covers many aspects of our everyday experience. This textbook aims to create awareness and to understand certain essential aspects by the state curriculum framework (NCF) which was formulated in 2005, followed by the state curriculum framework (SCF) in 2010. Based on these two framework, reconstruction of the curriculum and preparation of a revised syllabus has been done and designed now.

The subject chemistry is the study of substances, their properties, structures and transformation. The world is full of chemical substances and we need chemicals for many useful purposes. Our body is a huge chemical factory. Keeping this in mind, the textbook is written in organized manner. You can learn a very basic principles, understand facts and put them into practice by learning in the classroom and laboratory. The textbook is presented in a simple language with relevant diagrams, graphs, tables, photographs. This will help you to understand various terminology, concepts with more clarity. All the illustrations are in color form. The new syllabus focuses on the basic principles, concepts, laws based on precise observations, their applications in everyday life and ability to solve different types of problems. The general teaching - learning objectives of the revised syllabus are further determined on the basis of the 'Principle of constructivism' i.e. self learning.

The curriculum and syllabus is designed to make the students to think independently. The student are encouraged to read, study more through the additional information given in the colored boxes. Activities have been introduced in each chapter. These activities will not only help to understand the content knowledge on your own efforts. QR code have been introduced for gaining the additional information, abstracts of chapters and practice questions/ activities.

The efforts taken to prepare the text book will help the students think about more than just the content of the chemical concepts. Teachers, parents as well as those aspiring candidates preparing for the competitive examinations will also be benefited.

We look forward to a positive response from the teachers and students.

Our best wishes to all !



(Dr. Sunil Magar)

Director

Maharashtra State Bureau of
Textbook Production and
Curriculum Research, Pune 4

Pune

Date : 20 June 2019

Bharatiya Saur : 30 Jyeshtha 1941

- For Teachers -

Dear Teachers,

We are happy to introduce the revised textbook of chemistry for std. XI. This book is a sincere attempt to follow the maxims of teaching as well as develop a 'constructivist' approach to enhance the quality of learning. The demand for more activity based, experiential and innovative learning opportunities is the need of the time. The present curriculum has been restructured so as to bridge the credibility gap that exists in the experience in the outside world. Guidelines provided below will help to enrich the teaching - learning process and achieve the desired learning outcomes.

- To begin with, get familiar with the textbook yourself.
- The present book has been prepared for constructivism and activity based learning.
- Teachers must skillfully plan and organize the activities provided in each chapter to develop interest as well as to stimulate the thought process among the students.
- Always teach with proper planning.
- Use teaching aids as required for the proper understanding of the subject.
- Do not finish the chapter in short.
- Follow the order of the chapters strictly as listed in the contents because the units are introduced in a graded manner to facilitate knowledge building.
- Each unit is structured in a definite manner. It starts from the basic concepts of general chemistry required for each branch of chemistry. Application of this knowledge will help students to understand further chapters in each unit.
- Each chapter provides solved problems on each and every concept and various laws. The solved problems are put into boxes. Teachers should explain each step of the problem and give them practice.
- Ask the students about the related information, background about the chapter. You are provided, for this with the different boxes like 'Can You Recall', 'Do you know?'
- Encourage the students to collect related information by providing them the websites.
- Teaching- learning interactions, processes and participation of all students are necessary and so is your active guidance.
- Do not use the content of the boxes titles 'Do you know?' for evaluation.
- Exercises include parameters such as correlation, critical thinking, analytical reasoning etc. Evaluation pattern should be based on the given parameters. Equal weightage should be assigned to all the topics. Use different combinations of questions.



Remember



Try this



Can you recall?



Can you tell?

Front Page : The photograph depicts transmission electron micrograph (TEM) of a few layer Graphene (left). The electron diffraction pattern (hexagonal arrangement of spots corresponds to the hexagonal symmetry of the structure of Graphene (Right).

Picture Credit : Prof. Dr. M. A. More, Department of Physics, Savitribai Phule Pune University, Pune 411007.



Use your brain power



Just think



Activity :



Do you know ?



Exercises



Observe and Discuss



Find out



Internet my friend

DISCLAIMER Note : All attempts have been made to contact copy right/s (©) but we have not heard from them. We will be pleased to acknowledge the copy right holder (s) in our next edition if we learn from them.

Competency Statements - Standard XI

Area/ Unit/ Lesson	After studying the contents in Textbook students.....
<i>General chemistry</i>	<ul style="list-style-type: none"> • Understand the SI unit of important fundamental scientific quantities. • Explain various fundamental laws of chemical combination, which are applied in day-to-day life. • Relate basic concepts of number of moles and molecules. • Differentiate between quantitative and qualitative analysis. • Develop accuracy, precision, concentration ability in taking accurate reading. • Calculate empirical formula and molecular formula of compounds. • Obtain information about different techniques to purify substance as well as separation of miscible solids and liquids. • Gain the information about various theories, principles, put up by eminent Scientists leading to atomic structure. • Classify elements isotopes, isobars and isotones. • Understand the dual nature of electron. • Application of concept of quantum number in writing electronic configuration of various elements.
<i>Inorganic chemistry</i>	<ul style="list-style-type: none"> • Inculcate social and scientific awareness by gaining knowledge of oxidation-reduction concept. • Evaluate oxidation number of elements and balance the redox reaction by different methods. • Categorize oxidizing and reducing agents with their applications. • Classify elements based on electronic configuration. • Understand co-relation between the various properties like atomic size, valency, oxidation state, ionization enthalpy and electronegativity in a group and in a period. • Recognize isoelectronic species. • Compare the trends in physical and chemical properties in group I and group II. Understand the diagonal relationship. • Gain the knowledge of hydrogen from periodic table. • Develop interest in systematic study of elements present in Group 13, Group 14 and group 15. • Learn anomalous behaviors of boron, carbon and nitrogen . • Draw the structures of some compounds of boron, carbon and nitrogen. • Elaborate information about various theories to explain nature of bonding in formation of molecules. • Inculcate skill to draw Lewis structure of molecules. • Assign the structures of various compounds with respect to geometry, bond angle and types of bond.

<i>Physical chemistry</i>	<ul style="list-style-type: none"> • Generate environmental awareness by compiling concepts of adsorption phenomenon. • Learn science behind the fact about colloids in day to day life. • Interpret nature, difference and relation of equilibrium constant. • Design the suitable conditions to get more yield of the desired product. • Differentiate nuclear reactions with ordinary chemical reaction. • Acquire knowledge of natural radioactivity and related terms like nuclear transmutation, nuclear fission, nuclear fusion. • Clarify the beneficial and harmful effects of radioactivity. • State the applications of radioactive elements like carbon dating, nuclear reactor, generation of electricity and medicinal uses. • Develop mathematical skills in finding radioactive decay constant, half life period and nuclear binding energy.
<i>Organic chemistry</i>	<ul style="list-style-type: none"> • Interpret the structure and functional group of organic compounds. • IUPAC nomenclature of organic compounds. • Understand the influence of electronic displacement and reactivity in organic molecules. • Draw the formulae of various isomers of organic compounds. • Illustrate different methods of preparation and chemical properties of hydrocarbons. • Infer importance of hydrocarbon. • Gain information of medicinal properties of some chemical compounds and chemistry behind food quality and cleansing action.

CONTENTS

Sr. No	Title	Page No
1	Some Basic Concepts of Chemistry	1 - 12
2	Introduction to Analytical Chemistry	13 - 26
3	Basic Analytical Techniques	27 - 34
4	Structure of Atom	35 - 54
5	Chemical Bonding	55 - 80
6	Redox Reaction	81- 92
7	Modern Periodic Table	93 - 109
8	Elements of Group 1 and 2	110 - 122
9	Elements of Group 13, 14 and 15	123 - 134
10	States of Matter	135 - 159
11	Adsorption and Colloids	160 - 173
12	Chemical Equilibrium	174 - 189
13	Nuclear Chemistry and Radioactivity	190 - 203
14	Basic Principles of Organic Chemistry	204 - 232
15	Hydrocarbons	233 - 260
16	Chemistry in Everyday Life	261 - 270

1. Some Basic Concepts of Chemistry

1.1 Introduction : Chemistry is the study of matter, its physical and chemical properties and the physical and chemical changes it undergoes under different conditions.

1.2.1. Matter : You have learnt earlier that matter occupies space and has mass. **Matter** can be further **classified** into pure substances and mixtures **on the basis of chemical composition.**

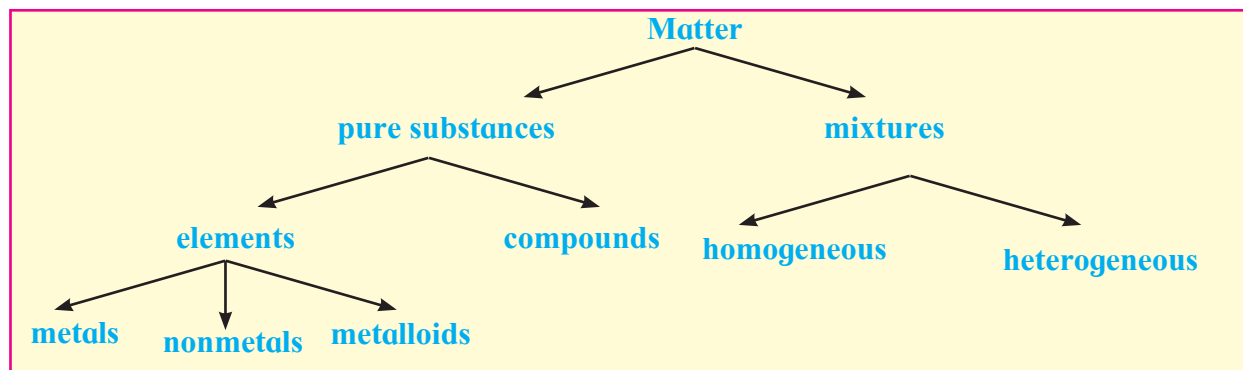

Chemistry is a central science. Its knowledge is required in the studies of physics, biological sciences, applied sciences, and earth and space sciences. The scope of chemistry is in every aspect of life, for example, the air we breathe, the food we eat, the fluids we drink, our clothing, transportation and fuel supplies, and so on.

Though it is an ancient science, due to development and advancement in science and technology, chemistry has developed as modern science. Technological development in sophisticated instruments expanded our knowledge of chemistry which, now, has been used in applied sciences such as medicine, dentistry, engineering, agriculture and in daily home use products.

1.2 Nature of Chemistry : Chemistry is traditionally classified further into five branches : organic, inorganic, physical, bio and analytical. Organic chemistry is the study of the properties and reactions of compounds of carbon. Inorganic chemistry is the study of all substances which are not organic. Physical chemistry is the study of principles underlying chemistry. It deals with the studies of properties of matter. It is study of atoms, molecules, and fundamental concepts related to electrons, energies and dynamics therein. It provides basic framework for all the other branches of chemistry.

Let us understand first what are pure substances and mixtures.

1.2.2 Pure substances versus mixtures :

Pure substances have a definite chemical composition. They always have the same properties regardless of their origin. Mixtures have no definite chemical composition and hence no definite properties.

Examples of pure substances : Pure metal, distilled water, etc.

Examples of mixtures : Paint (mixture of oils, pigment, additive), concrete (a mixture of sand, cement, water)



Can you tell?

Which are mixtures and pure substances from the following ?

- sea water
- gasoline
- skin
- a rusty nail
- a page of the textbook.
- diamond

Pure substances are further divided into elements and compounds. **Elements are pure substances which can not be broken down into simpler substances by ordinary chemical changes.** Elements are further classified as metals, nonmetals and metalloids.

1. Metals :

- i. have a lustre (a shiny appearance).
- ii. conduct heat and electricity.
- iii. can be drawn into wire (are ductile).
- iv. can be hammered into thin sheets (are malleable).

Examples : gold, silver, copper, iron. Mercury is a liquid metal at room temperature.

2. Non-metals :

- i. have no lustre. (exception : diamond, iodine)
- ii. are poor conductors of heat and electricity. (exception : graphite)
- iii. can not be hammered into sheets or drawn into wire, because they are brittle.

Examples : Iodine, nitrogen, carbon, etc.

3. Metalloids : Some elements have properties intermediate between metals and non-metals and are called metalloids or semi-metals. Examples include arsenic, silicon and germanium.

Compounds are the pure substances which can not be broken down into simpler substances by ordinary chemical changes. In a compound, two or three elements are combined in a fixed proportion.

Mixture contains two or more substances in no fixed proportions and may be separated by physical methods. Mixtures are further divided into homogeneous and heterogeneous. Solutions are homogeneous mixtures, because the molecules of constituent solute and solvent are uniformly mixed throughout its bulk. In heterogeneous mixtures the molecules of the constituents are not uniformly mixed throughout the bulk. For example : Suspension of an insoluble solid in a liquid.

1.2.3 States of matter : You are also aware that matter exists in three different states namely gas, liquid and solid. You are going to learn about these states in unit 3 (chapter 10).

In solids, constituent atoms or molecules (particles) are tightly held in perfect order and therefore solids possess definite shape and volume. Liquids contain particles close to each other and they can move around within the liquid. While in gases, the particles are far

apart as compared to those in liquid and solid state.

Three states of matter are interconvertible by changing the conditions of temperature and pressure.



Can you tell?

Classify the following as element and compound.

- i. mercuric oxide
- ii. helium gas
- iii. water
- iv. table salt
- v. iodine
- vi. mercury
- vii. oxygen
- viii. nitrogen

1.3 Properties of matter and their measurement :



Fig : 1.1 Burning of magnesium wire

Different kinds of matter have characteristic properties, which can be classified into two categories as **physical properties** and **chemical properties**.

Physical properties are those which can be measured or observed without changing the chemical composition of the substance. Colour, odour, melting point, boiling point, density, etc. are physical properties. Chemical properties are the properties where substances undergo a chemical change and thereby exhibit change in chemical composition. For example, coal burns in air to produce carbon dioxide or magnesium wire burns in air in the presence of oxygen to form magnesium oxide. (Fig. 1.1)

1.3.1 Measurement of properties : Many properties of matter are quantitative in nature. When you measure something, you are comparing it with some standard. The standard quantity is reproducible and unchanging.

Many properties of matter such as mass, length, area, pressure, volume, time, etc. are quantitative in nature. Any quantitative measurement is expressed by a number followed by units in which it is measured. For example, length of class room can be represented as 10 m. Here 10 is the number and 'm' denotes metre-the unit in which the length is measured.

The standards are chosen arbitrarily with some universally accepted criteria. **"The arbitrarily decided and universally accepted standards are called units."**

There are several system in which units are expressed such as CGS (centimetre for length, gram for mass and second for time), FPS (foot, pound, second) and MKS (metre, kilogram, second) systems, etc.

SI units :

In 1960, the general conference of weights and measure, proposed revised metric system, called **International System of units**, that is, **SI units**.

The metric system which originated in France in late eighteenth century, was more convenient as it was based on the decimal system. Later, based on a common standard system, the International System of Units (SI units) was established.

The SI system has seven base units as listed in Table 1.1. These are fundamental scientific quantities. Other units like speed, volume, density, etc. can be derived from these quantities.

Table 1.1 S.I. Fundamental units

Base Physical Quantity	Symbol for Quantity	Name of SI Unit	Symbol for SI Unit
Length	<i>l</i>	metre	m
Mass	<i>m</i>	kilogram	kg
Time	<i>t</i>	second	s
Electric current	<i>I</i>	ampere	A
Thermodynamic temperature	<i>T</i>	Kelvin	K
Amount of substance	<i>n</i>	mole	mol
Luminous intensity	<i>I_v</i>	candela	cd

1.3.2 Physical properties

i. Mass and weight : We know that matter has mass. So mass is an inherent property of matter. It is the measure of the quantity of matter a body contains. The mass of a body does not vary as its position changes. On the other hand, the weight of a body is result of the mass and gravitational attraction. The weight of a body varies because the gravitational attraction of the earth for a body varies with the distance from the centre of the earth.

Hence, **the mass of a body is more fundamental property than its weight.**

The basic unit of mass in the SI system is the kilogram as given in Table 1.1. However, a fractional quantity 'gram' is used for weighing small quantities of chemicals in the laboratories. Therefore, in terms of grams it is defined ($1\text{kg} = 1000\text{g} = 10^3\text{g}$)

ii. Length : In chemistry we come across 'length' while express in properties such as the atomic radius, bond length, wavelength of electromagnetic radiation, and so on. These quantities are very small therefore fractional units of the SI unit of length are used for example, nanometre (nm), picometre (pm). Here $1\text{nm} = 10^{-9}\text{m}$, $1\text{pm} = 10^{-12}\text{m}$.

iii. Volume : It is the amount of space occupied by a three dimensional object. It does not depend on shape. For measurement of volume of liquids and gases, a common unit, litre (L) which is not an SI unit is used.

$1\text{L} = 1\text{dm}^3 = 1000\text{mL} = 1000\text{cm}^3$
 $1000\text{cm}^3 = 10\text{cm} \times 10\text{cm} \times 10\text{cm}$ of volume
 SI unit of volume is expressed as $(\text{metre})^3$ or m^3 .

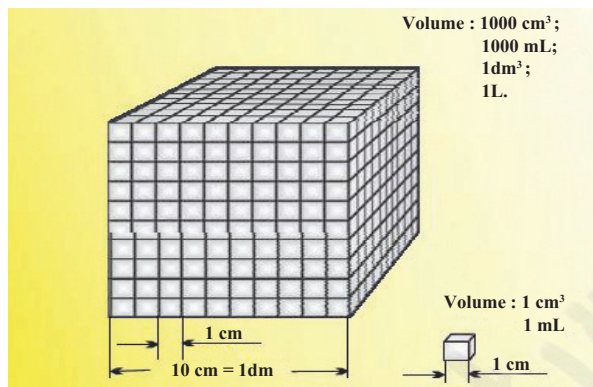

Fig. 1.2 : Litre and SI unit of volume

Different kinds of glassware are used to measure the volume of liquids and solutions. For example, graduated cylinder, burette, pipette, etc. A volumetric flask is used to prepare a known volume of a solution. Figure 1.3 shows the types of apparatus used in laboratory for measuring volume of liquids.

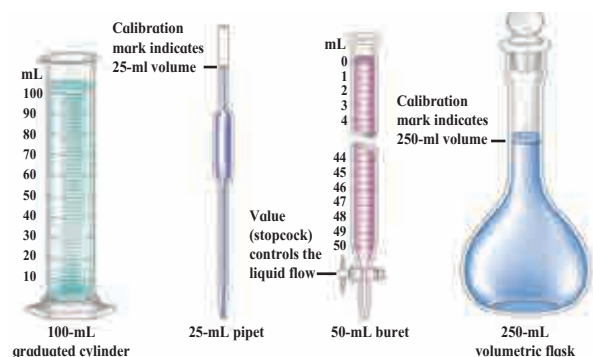

Fig. 1.3 : Volumetric glass apparatus

iv. Density : Density of a substance is its mass per unit volume. It is determined in the laboratory by measuring both the mass and the volume of a sample. The density is calculated by dividing mass by volume. It is the characteristic property of a substance. So SI unit of density can be obtained as follows:

$$\begin{aligned} \text{SI unit of density} &= \frac{\text{SI unit of mass}}{\text{SI unit of volume}} \\ &= \frac{\text{kg}}{\text{m}^3} \text{ or } \text{kg m}^{-3} \end{aligned}$$

CGS units it is $\frac{\text{g}}{\text{mL}}$ or g mL^{-1} or g cm^{-3}

v. Temperature : Temperature is a measure of the hotness or coldness of an object. There are three common scales to measure temperature, namely $^{\circ}\text{C}$ (degree Celsius), $^{\circ}\text{F}$ (degree

Fahrenheit) and K (Kelvin). Here K is the SI unit. Figure 1.4 shows the thermometers based on these scales.

Generally, the thermometer with celsius scale are calibrated from 0°C to 100°C where these two temperatures are respectively the freezing point and the boiling point of water at atmospheric pressure. These are represented on fahrenheit scale as 32°F to 212°F .

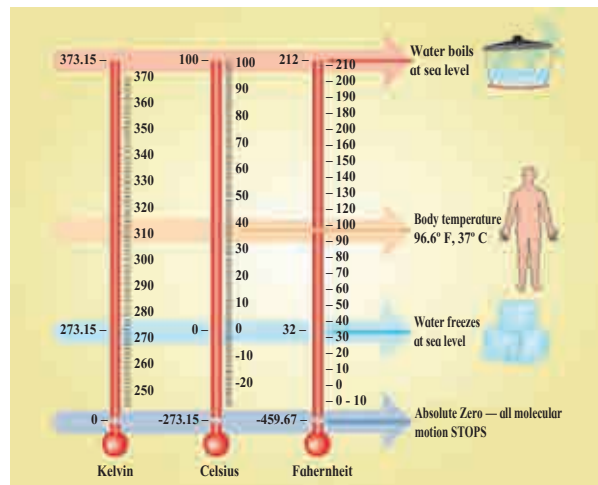

Fig 1.4 : Thermometers of different temperature scale

The temperatures on two scales are related to each other by the following relationship :

$$^{\circ}\text{F} = \frac{9}{5}(^{\circ}\text{C}) + 32$$

The Kelvin scale is related to Celsius scale as follows :

$$\text{K} = ^{\circ}\text{C} + 273.15$$

1.4 Laws of Chemical Combination : The elements combine with each other and form compounds. This process is governed by five basic laws discovered before the knowledge of molecular formulae.

1.4.1 Law of conservation of mass : Antoine



Lavoisier (1743-1794) a French scientist is often referred to as the father of modern chemistry. He carefully performed many combustion experiments, namely,

burning of phosphorus and mercury, both in the presence of air. Both resulted in an increase in weight. After several experiments he found that the weight gained by the phosphorus was

exactly the same as the weight lost by the air. He observed that,

$$\begin{aligned} \text{Total mass of reactants} \\ = \text{Total mass of products} \end{aligned}$$

When hydrogen gas burns and combines with oxygen to yield water, the mass of the water formed is equal to the mass of the hydrogen and oxygen consumed. Thus, the law of conservation of mass states that **'mass can neither be created nor destroyed.'**

1.4.2 Law of Definite Proportions :

French chemist, Joseph Proust performed experiments on two samples of cupric carbonate. One of the samples was natural in origin and the other was a synthetic one. He found that the composition of elements present in it was same for both the samples as shown below :

Cupric Carbonate	% of copper	% of oxygen	% of carbon
Natural sample	51.35	9.74	38.91
Synthetic sample	51.35	9.74	38.91

This led Joseph Proust to state the law of definite proportion as follows :

'A given compound always contains exactly the same proportion of elements by weight.'

Irrespective of the source, a given compound always contains same elements in the same proportion. The validity of this law has been confirmed by various experiments. This law is sometimes referred to as **Law of definite composition.**

1.4.3 Law of multiple proportions :

This law was proposed by John Dalton in 1803. It has been observed that two or more elements may form more than one compound. Law of multiple proportions summarizes many experiments on such compounds. **When two elements A and B form more than one compounds, the masses of element B that combine with a given mass of A are always in the ratio of small whole numbers.** For example, i. Hydrogen combines with oxygen to form two compounds, namely water and

hydrogen peroxide.

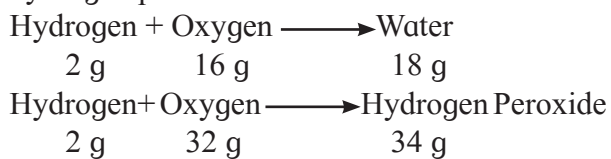

Here, it is found that, the two masses of oxygen i.e. 16 g and 32 g which combine with a fixed mass of hydrogen (2g) are in the ratio of small whole numbers, i. e. 16:32 or 1:2.

ii. Nitrogen and oxygen combine to form two compounds, nitric oxide and nitrogen dioxide.

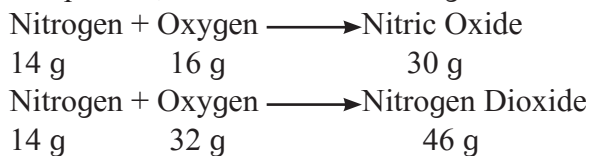

Here, you find that the two masses of oxygen i.e. 16 g and 32 g when combine with a fixed mass of Nitrogen (14 g) are in the ratio of small whole numbers i.e. 16:32 or 1:2.

(Similar examples such as CO and CO₂ (1:2 ratio), SO₂ and SO₃ (2:3 ratio), can be found.)

1.4.4 Gay Lussac Law of Gaseous Volume :

This law was put forth by Gay Lussac in 1808. The law states that **when gases combine or are produced in a chemical**



reaction they do so in a simple ratio by volume, provided all gases are at same temperature and pressure.

Illustration : i. Under the same conditions of temperature and pressure, 100 mL of hydrogen

combines with 50 mL of oxygen to give 100 mL of water vapour.

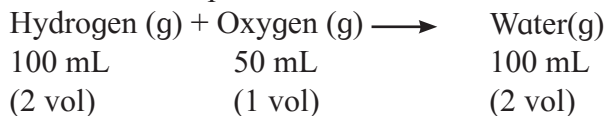

Thus, the volumes of hydrogen gas and oxygen gas which combine together i.e. 100 mL and 50 mL producing two volumes of water vapour which amounts to 100 mL bear a simple ratio of 2:1:2

ii. Under the same condition of temperature and pressure,

1 L of nitrogen gas combines with 3 L of hydrogen gas to produce 2 L of ammonia gas.
 $\text{Nitrogen (g)} + \text{Hydrogen (g)} \longrightarrow \text{Ammonia (g)}$
 1 L 3 L 2 L
 (1 vol) (3 vol) (2 vol)

Thus, the volume of nitrogen gas and hydrogen gas which combine together i.e. 1 L and 3 L and volume of ammonia gas produced i. e. 2 L bear a simple ratio of 1:3:2.



Remember

Gay Lussac's discovery of integer ratio in volume relationship is actually the law of definite proportion by gaseous volumes.



Can you tell?

If 10 volumes of dihydrogen gas react with 5 volumes of dioxygen gas, how many volumes of water vapour would be produced?



1.4.5 Avogadro Law : In 1811, Avogadro proposed that **equal volumes of all gases at the same temperature and pressure contain equal number of molecules.**

If we consider the reaction of hydrogen and oxygen to produce water vapour.

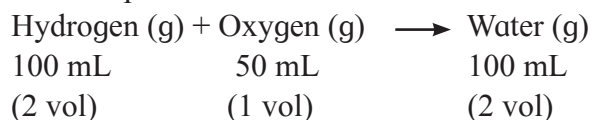

(Gay Lussac Law)



(Avogadro law)



We see that 2 volumes of hydrogen combine with 1 volume of oxygen to give 2 volumes of water vapour, without leaving any unreacted oxygen. According to Avogadro law, if 1 volume contains n molecules, then 2n molecules of hydrogen combine with n molecules of oxygen to give 2n molecules of water.

Therefore, 2 molecules of hydrogen gas combine with 1 molecule of oxygen to give 2 molecules of water vapour. Avogadro could explain the above result by considering the molecules to be polyatomic. If hydrogen and oxygen were considered as diatomic, as recognized now, then the above results are easily understandable.



Remember

Avogadro made a distinction between atoms and molecules, which is quite understandable in the present time.

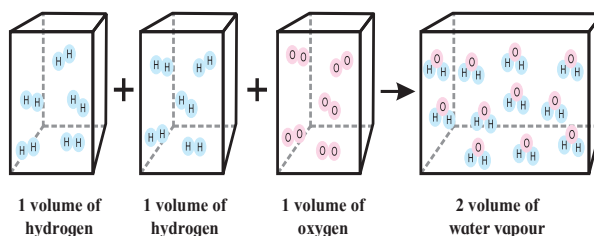

Fig. 1.5 : two volume of hydrogen react with one volume of oxygen to give two volumes of water vapour

1.5 Dalton's Atomic Theory : In 1808, Dalton published "A New System of chemical philosophy" in which he proposed the following features, which later became famous as Dalton's atomic theory.

1. Matter consists of **tiny, indivisible particles** called **atoms**.
 2. All the atoms of a given elements have **identical** properties including **mass**. Atoms of different elements differ in mass.
 3. **Compounds** are formed when atoms of different elements combine in a fixed ratio.
 4. **Chemical reactions** involve only the **reorganization of atoms**. Atoms are neither created nor destroyed in a chemical reaction.
- Dalton's theory could explain all the laws of chemical combination.



Can you recall?

What is an atom and molecule ? What is the order of magnitude of mass of one atom ? What are isotopes?

1.6 Atomic and molecular masses : You know about the terms atoms and molecules. Thus it is appropriate here to understand what we mean by atomic and molecular masses.

1.6.1 Atomic Mass : Every element has a characteristic atomic mass. Atomic mass is the mass of an atom. It is actually very very small. For example, the mass of one hydrogen atom is 1.6736×10^{-24} g. This is very small quantity and not easy to measure.

In the present system, mass of an atom is determined relative to the mass of a carbon - 12 atom as the standard and this has been agreed upon in 1961. In this system, an atom of carbon-12 is assigned a mass of exactly 12.00000 atomic mass unit (**amu**) and all other atoms of other elements are given a relative atomic mass, to that of carbon - 12. The atomic masses are expressed in **amu**. **One amu is defined as a mass exactly equal to one twelfth of the mass of one carbon-12 atom.** Later on the exact value of atomic mass unit in grams was experimentally established.

$$\begin{aligned} 1 \text{ amu} &= \frac{1}{12} \times \text{mass of one C-12} \\ &= \frac{1}{12} \times 1.992648 \times 10^{-23} \text{ g} \\ &= 1.66056 \times 10^{-24} \text{ g} \end{aligned}$$

Recently, amu has been replaced by **unified mass unit** called **dalton** (symbol 'u' or 'Da'), 'u' means unified mass.

Problem 1.1 : Mass of an atom of oxygen in gram is 26.56896×10^{-24} g. What is the atomic mass of oxygen in u ?

Solution : Mass of an atom of oxygen in gram is 26.56896×10^{-24} g, and $1.66056 \times 10^{-24} \text{ g} = 1 \text{ u}$
 $\therefore 26.56896 \times 10^{-24} \text{ g} = ?$

$$= \frac{26.56896 \times 10^{-24} \text{ g}}{1.66056 \times 10^{-24} \text{ g/u}} = 16.0 \text{ u}$$

Similarly mass of an atom of hydrogen = 1.0080 u

1.6.2 Average Atomic Mass : Many naturally occurring elements exist as mixture of more than one isotope. Isotopes have different atomic masses. The atomic mass of such an element is the weighted average of atomic masses of its isotopes (taking into account the atomic masses of isotopes and their relative abundance i.e. percent occurrence). This is called **average atomic mass** of an element. For example, carbon has the following three isotopes with relative abundances and atomic masses as shown against each of them.

Isotope	Atomic mass (u)	Relative Abundance (%)
^{12}C	12.00000	98.892
^{13}C	13.00335	1.108
^{14}C	14.00317	2×10^{-10}

From the above data, the average atomic mass of carbon

$$\begin{aligned} &= (12 \text{ u}) (98.892/100) + (13.00335 \text{ u}) \\ &\quad (1.108/100) + (14.00317) (2 \times 10^{-10}/100) \\ &= 12.011 \text{ u} \end{aligned}$$

Similarly, average atomic masses for other elements can be calculated.



Remember

- In the periodic table of elements, the atomic masses mentioned for different elements are actually their average atomic masses.
- For practical purpose, the average atomic mass is rounded off to the nearest whole number when it differs from it by a very small fraction.

Element	Isotopes	Average atomic mass	Rounded off atomic mass
Carbon	^{12}C , ^{13}C , ^{14}C	12.011 u	12.0 u
Nitrogen	^{14}N , ^{15}N	79.904 u	14.0 u
Oxygen	^{16}O , ^{17}O , ^{18}O	15.999 u	16.0 u
Chlorine	^{35}Cl , ^{37}Cl	35.453 u	35.5 u
Bromine	^{79}Br , ^{81}Br	79.904 u	79.9 u

Problem 1.2 : Calculate the average atomic mass of neon using the following data :

Isotope	Atomic mass	Natural Abundance
^{20}Ne	19.9924 u	90.92%
^{21}Ne	20.9940 u	0.26 %
^{22}Ne	21.9914 u	8.82 %

Solution : Average atomic mass of Neon (Ne)

$$= \frac{\text{Atomic mass of } ^{20}\text{Ne} \times \% + \text{Atomic mass of } ^{21}\text{Ne} \times \% + \text{Atomic mass of } ^{22}\text{Ne} \times \%}{100}$$

$$= \frac{(19.9924\text{u})(90.92) + (20.9940\text{u})(0.26) + (21.9914\text{u})(8.82)}{100} = 20.1707 \text{ u}$$

1.6.3 Molecular Mass : Molecular mass of a substance is the sum of average atomic masses of the atoms of an element which constitute the molecule. Molecular mass of a substance is the mass of one molecule of that substance relative to the mass of one carbon-12 atom. It is obtained by multiplying average atomic mass of each element by the number of its atoms and adding them together.

For example, the molecular mass of carbon dioxide (CO_2) is

$$= 1(\text{average atomic mass of C})$$

$$+ 2(\text{average atomic mass of O})$$

$$= 1(12.0 \text{ u}) + 2(16.0 \text{ u}) = 44.0 \text{ u}$$

Some more examples of calculations of molecular mass.

- $\text{H}_2\text{O} = 2 \times 1 \text{ u} + 16 \text{ u} = 18 \text{ u}$
- $\text{C}_6\text{H}_5\text{Cl} = (6 \times 12 \text{ u}) + (5 \times 1 \text{ u}) + (35.5 \text{ u})$
 $= 112.5 \text{ u}$
- $\text{H}_2\text{SO}_4 = (2 \times 1 \text{ u}) + (32 \text{ u}) + (4 \times 16 \text{ u}) = 98 \text{ u}$

Problem 1.3 : Find the mass of 1 molecule of oxygen (O_2) in amu (u) and in grams.

Solution : Molecular mass of $\text{O}_2 = 2 \times 16 \text{ u}$
 \therefore mass of 1 molecule = 32 u
 \therefore mass of 1 molecule of O_2
 $= 32.0 \times 1.66056 \times 10^{-24} \text{ g}$
 $= 53.1379 \times 10^{-24} \text{ g}$

1.6.4 Formula Mass

Some substances such as sodium chloride do not contain discrete molecules as the constituent units. In such compounds, cationic (sodium) and anionic (chloride) entities are arranged in a three dimensional structure.

In sodium chloride crystal, one Na^{\oplus} ion is surrounded by six Cl^{\ominus} ions, all at the same distance from it and vice versa. Therefore, NaCl is just the formula used to represent sodium chloride, though it is not a molecule. Similarly, a term 'formula mass' is used for such ionic compounds, instead of molecular mass. **The formula mass of a substance is the sum of atomic masses of the atoms present in the formula.**

Problem 1.4 : Find the formula mass of

- NaCl
 - $\text{Cu}(\text{NO}_3)_2$
- i. Formula mass of NaCl
 $=$ average atomic mass of Na
 $+$ average atomic mass of Cl
 $= 23.0 \text{ u} + 35.5 \text{ u} = 58.5 \text{ u}$
- ii. Formula mass of $\text{Cu}(\text{NO}_3)_2$
 $=$ average atomic mass of Cu + 2 \times (average atomic mass of nitrogen + average atomic mass of three oxygen)
 $= (63.5) + 2(14 + 3 \times 16) = 187.5 \text{ u}$

**Try this**

Find the formula mass of CaSO_4
 If atomic mass of Ca = 40.1 u,
 S = 32.1 u and O = 16.0 u

1.7 Mole concept and molar mass**Can you recall?**

- One dozen means how many items ?
- One gross means how many items ?

Mole : Expressing large count of objects is made easy by using quantitative adjectives such as dozen, gross. You know that even a small amount of any substance contains very large number of atoms or molecules. We use a quantitative adjective 'mole' to express the large number of submicroscopic entities like atoms, ions, electrons, etc. present in a substance.

Definiton : One mole is the amount of a substance that contains as many entities or particles as there are atoms in exactly 12 g (or 0.012 kg) of the carbon -12 isotope.

Let us calculate the number of atoms in 12.0000 g of Carbon-12 isotopes. Mass of one carbon-12 atom (determined by mass spectrometer) = 1.992648×10^{-23} g,
Mass of one mole carbon atom = 12 g
 \therefore Number of atoms in 12 g of carbon -12

$$= \frac{12\text{g/mol}}{1.992648 \times 10^{-23}\text{g/atom}}$$

$$= 6.0221367 \times 10^{23} \text{ atom/mol}$$

Thus one mole is the amount of a substance that contains 6.0221367×10^{23} particles/entities (such as atoms, molecules or ions).

Note that the name of the unit is **mole** and the symbol for the unit is **mol**.



Remember

The number 6.0221367×10^{23} is known as '**Avogadro's Constant**' in the honour of Amedeo Avogadro.

In SI system, mole (Symbol mol) was introduced as seventh base quantity for the amount of a substance.

Example :

1 mole of oxygen atoms = 6.0221367×10^{23} atoms of oxygen

1 mole of water molecules = 6.0221367×10^{23} molecules of water

1 mole of sodium chloride = 6.0221367×10^{23} formula units of NaCl

Molar Mass : The mass of one mole of a substance (element/compound) in grams is called its molar mass. The molar mass of any element in grams is numerically equal to atomic mass of that element in u.

Element	Atomic mass (u)	Molar mass (g mol ⁻¹)
H	1.0 u	1.0 g mol ⁻¹
C	12.0 u	12.0 g mol ⁻¹
O	16.0 u	16.0 g mol ⁻¹

Simillary molar mass of any substance, existing as polyatomic molecule, in grams is numerically equal to its molecular mass or formula mass in u.

Polyatomic substance	Molecular/ formula mass (u)	Molar mass (g mol ⁻¹)
O ₂	32.0 u	32.0 g mol ⁻¹
H ₂ O	18.0 u	18.0 g mol ⁻¹
NaCl	58.5 u	58.5 g mol ⁻¹

Molar mass of O atoms

$$= 6.022 \times 10^{23} \text{ atom/mol} \times 16 \text{ u/atom}$$

$$\times 1.66056 \times 10^{-24} \text{ g/u} = 16.0 \text{ g/mol}$$

Problem 1.5 : Calculate the number of moles and molecules of urea present in 5.6 g of urea.

Solution : Mass of urea = 5.6 g
Molecular mass of urea, NH₂CONH₂
= 2 (average atomic mass of N) + 4 (average atomic mass of H) + 1 (average atomic mass of C) + 1 (average atomic mass of O)
= $2 \times 14 \text{ u} + 1 \times 12 \text{ u} + 4 \times 1 \text{ u} + 1 \times 16 \text{ u}$
= 60 u

\therefore molar mass of urea = 60 g mol⁻¹

Number of moles

$$= \frac{\text{mass of urea in g}}{\text{molar mass of urea in g mol}^{-1}}$$

$$= \frac{5.6 \text{ g}}{60 \text{ g mol}^{-1}} = 0.0933 \text{ mol}$$

Number of molecules = Number of moles \times Avogadro's constant

Number of molecules of urea
= $0.0933 \times 6.022 \times 10^{23} \text{ molecules/mol}$
= $0.5618 \times 10^{23} \text{ molecules}$
= $5.618 \times 10^{22} \text{ molecules}$

Ans : Number of moles = 0.0933 mol

Number of molecules of urea
= $5.618 \times 10^{22} \text{ molecules}$

Problem 1.6 : Calculate the number of atoms in each of the following

- 52 moles of Argon (Ar)
- 52 u of Helium (He)
- 52 g of Helium (He)

Solution :

i. 52 moles of Argon

1 mole Argon atoms = 6.022×10^{23} atoms of Ar

\therefore 52 moles of Ar

$$= 52 \text{ moles} \times \frac{6.022 \times 10^{23}}{1 \text{ mol}} \text{ atoms}$$

$$= 313.144 \times 10^{23} \text{ atoms of Argon}$$

ii. 52 u of Helium

Atomic mass of He = mass of 1 atom of He = 4.0u

$$\therefore 4.0 \text{ u} = 1 \text{ He} \therefore 52 \text{ u} = ?$$

$$= 52 \text{ u} \times \frac{1 \text{ atom}}{4.0 \text{ u}} = 13$$

atoms of He

iii. 52 g of He

Mass of 1 mole of He = 4.0 g

Number of moles of He

$$= \frac{\text{mass of He}}{\text{mass of 1 mole of He}}$$

$$= \frac{52 \text{ g}}{4.0 \text{ g mol}^{-1}} = 13 \text{ mol}$$

Number of atoms of He

$$= \text{Number of moles} \times 6.022 \times 10^{23}$$

$$= 13 \text{ mol} \times 6.022 \times 10^{23} \text{ atoms/mol}$$

$$= 78.286 \times 10^{23} \text{ atoms of He.}$$

1.8 Moles and gases : Many substances exist as gases. If we want to find the number of moles of gas, we can do this more conveniently by measuring the volume rather than mass of the gas. Chemists have deduced from Avogadro law that "One mole of any gas occupies a volume of 22.4 dm^3 at **standard temperature (0 °C) and pressure (1 atm) (STP)**. The volume of 22.4 dm^3 at STP is known as molar volume of a gas.

Number of moles of a gas (n) =

$$\frac{\text{Volume of the gas at STP}}{\text{Molar volume of gas}}$$

Thus

Number of moles of a gas (n) =

$$\frac{\text{Volume of the gas at STP}}{22.4 \text{ dm}^3 \text{ mol}^{-1}}$$

Number of molecules = number of moles \times 6.022×10^{23} molecules mol^{-1}

(Note : IUPAC has recently changed the standard pressure to 1 bar. Under these new STP conditions the molar volume of a gas is 22.71 L mol^{-1})

Problem 1.7 : Calculate the number of moles and molecules of ammonia (NH_3) gas in a volume 67.2 dm^3 of it measured at STP.

Solution :

Volume of NH_3 at STP = 67.2 dm^3

molar volume of a gas = $22.4 \text{ dm}^3 \text{ mol}^{-1}$

Number of moles (n)

$$= \frac{\text{Volume of the gas at STP}}{\text{Molar volume of gas}}$$

$$\text{Number of moles of } \text{NH}_3 = \frac{67.2 \text{ dm}^3}{22.4 \text{ dm}^3 \text{ mol}^{-1}}$$

$$= 3.0 \text{ mol}$$

Number of molecules = Number of moles \times 6.022×10^{23} molecules mol^{-1}

$$\text{Number of molecules of } \text{NH}_3 = 3.0 \text{ mol} \times 6.022 \times 10^{23} \text{ molecules mol}^{-1}$$

$$= 18.066 \times 10^{23} \text{ molecules}$$



Try this

Calculate the volume in dm^3 occupied by 60.0 g of ethane at STP.



Exercises

1. Choose the most correct option.

- A. A sample of pure water, whatever the source always contains by mass of oxygen and 11.1 % by mass of hydrogen.
a. 88.8 b. 18 c. 80 d. 16
- B. Which of the following compounds can NOT demonstrate the law of multiple proportions ?
a. NO, NO₂ b. CO, CO₂
c. H₂O, H₂O₂ d. Na₂S, NaF
- C. Which of the following temperature will read the same value on celsius and Fahrenheit scales.
a. - 40⁰ b. + 40⁰
c. -80⁰ d. -20⁰
- D. SI unit of the quantity electric current is
a. Volt b. Ampere
c. Candela d. Newton
- E. In the reaction $N_2 + 3H_2 \longrightarrow 2NH_3$, the ratio by volume of N₂, H₂ and NH₃ is 1 : 3 : 2 This illustrates the law of
a. definite proportion
b. reciprocal proportion
c. multiple proportion
d. gaseous volumes
- F. Which of the following has maximum number of molecules ?
a. 7 g N₂ b. 2 g H₂
c. 8 g O₂ d. 20 g NO₂
- G. How many g of H₂O are present in 0.25 mol of it ?
a. 4.5 b. 18
c. 0.25 d. 5.4
- H. The number of molecules in 22.4 cm³ of nitrogen gas at STP is
a. 6.022×10^{20}
b. 6.022×10^{23}
c. 22.4×10^{20}
d. 22.4×10^{23}
- I. Which of the following has the largest number of atoms ?
a. 1g Au (s) b. 1g Na (s)
c. 1g Li (s) d. 1g Cl₂(g)

2. Answer the following questions.

- A. State and explain Avogadro's law.
B. Point out the difference between 12 g of carbon and 12 u of carbon
C. How many grams does an atom of hydrogen weigh ?
D. Calculate the molecular mass of the following in u.
a. NH₃ b. CH₃COOH c. C₂H₅OH
E. How many particles are present in 1 mole of a substance ?
F. What is the SI unit of amount of a substance ?
G. What is meant by molar volume of a gas ?
H. State and explain the law of conservation of mass.
I. State the law of multiple proportions.

3. Give one example of each

- A. homogeneous mixture
B. heterogeneous mixture
C. element D. compound

4. Solve problems :

- A. What is the ratio of molecules in 1 mole of NH₃ and 1 mole of HNO₃.
(Ans. : 1:1)
- B. Calculate number of moles of hydrogen in 0.448 litre of hydrogen gas at STP
(Ans. : 0.02 mol)
- C. The mass of an atom of hydrogen is 1.008 u. What is the mass of 18 atoms of hydrogen. (18.144 u)
- D. Calculate the number of atom in each of the following (Given : Atomic mass of I = 127 u).
a. 254 u of iodine (I)
b. 254 g of iodine (I)
(Ans. : 2 atoms, 1.2044×10^{24} atoms)
- E. A student used a carbon pencil to write his homework. The mass of this was found to be 5 mg. With the help of this calculate.
a. The number of moles of carbon in his homework writing.

(Ans : 4.16×10^{-4})

- b. The number of carbon atoms in 12 mg of his homework writing
(Ans : 6.022×10^{20})
- F. Arjun purchased 250 g of glucose ($C_6H_{12}O_6$) for Rs 40. Find the cost of glucose per mole.
(Ans : Rs 28.8)
- G. The natural isotopic abundance of ^{10}B is 19.60% and ^{11}B is 80.40 %. The exact isotopic masses are 10.13 and 11.009 respectively. Calculate the average atomic mass of boron
(Ans. :10.81)
- H. Convert the following degree Celsius temperature to degree Fahrenheit.
a. $40^\circ C$ b. $30^\circ C$
(Ans. : A. $104^\circ F$, B. $86^\circ F$)
- I. Calculate the number of moles and molecules of acetic acid present in 22 g of it.
(Ans. : 0.3666 moles, 2.2076×10^{23} molecules)
- J. 24 g of carbon reacts with some oxygen to make 88 grams of carbon dioxide. Find out how much oxygen must have been used.
(Ans. : 64.0)
- K. Calculate number of atoms is each of the following. (Average atomic mass : N = 14 u, S = 32 u)
a. 0.4 mole of nitrogen
b. 1.6 g of sulfur
(Ans. : A. 2.4088×10^{23} , B. 3.011×10^{22} atom)
- L. 2.0 g of a metal burnt in oxygen gave 3.2 g of its oxide. 1.42 g of the same metal heated in steam gave 2.27 of its oxide. Which law is verified by these data ?
- M. In two moles of acetaldehyde (CH_3CHO) calculate the following
a. Number of moles of carbon
b. Number of moles of hydrogen
c. Number of moles of oxygen
d. Number of molecules of acetaldehyde
(Ans. : A. 4 mol, B. 8 mol, C. 2 mol, D. 12.044×10^{23} molecules)
- N. Calculate the number of moles of magnesium oxide, MgO in i. 80 g and ii. 10 g of the compound. (Average atomic masses of Mg = 24 and O = 16)
(Ans. i. 2 mol ii. 0.25 mol)
- O. What is volume of carbon dioxide, CO_2 occupying by i. 5 moles and ii. 0.5 mole of CO_2 gas measured at STP.
(Ans. i. 112 dm^3 ii. 11.2 dm^3)
- P. Calculate the mass of potassium chlorate required to liberate 6.72 dm^3 of oxygen at STP. Molar mass of $KClO_3$ is 122.5 g mol^{-1} .
(Ans. 24.5 g)
- Q. Calculate the number of atoms of hydrogen present in 5.6 g of urea, $(NH_2)_2CO$. Also calculate the number of atoms of N, C and O.
(Ans. : No. of atoms of H = 2.24×10^{23} , N = 1.124×10^{23} and C = 0.562×10^{23} , O = 0.562×10^{23})
- R. Calculate the mass of sulfur dioxide produced by burning 16 g of sulfur in excess of oxygen in contact process. (Average atomic mass : S = 32 u, O = 16 u)
(Ans. 32 g)

5. Explain

- A. The need of the term average atomic mass.
B. Molar mass.
C. Mole concept.
D. Formula mass with an example.
E. Molar volume of gas.
F. Types of matter (on the basis of chemical composition).



Activity :

Collect information of various scientists and prepare charts of their contribution in chemistry.

2. Introduction to analytical chemistry

2.1 Introduction : Analytical chemistry facilitates investigation chemical composition of substances. It uses the instruments and methods to separate, identify and quantify the matter under study. The analysis thus provides chemical or physical information about a sample. Analysis may be qualitative or quantitative. Qualitative analysis is concerned with the detection of the presence or absence of elements in compounds and of chemical compounds in mixtures. Quantitative analysis deals with the determination of the relative proportions of elements in compounds and of chemical compounds in mixtures.



Remember

The branch of chemistry which deals with the study of separation, identification, qualitative and quantitative determination of the compositions of different substances, is called analytical chemistry.

Importance of analytical chemistry :

The course of analytical chemistry extends the knowledge acquired by the students in studying general, inorganic and organic chemistry. Chemical analysis is one of the most important methods of monitoring the composition of raw materials, intermediates and finished products, and also the composition of air in streets and premises of industrial plants. In agriculture, chemical analysis is used to determine the composition of soils and fertilizers; in medicine, to determine the composition of medicinal preparations. Analytical chemistry has applications in forensic science, engineering and industry. Industrial process as a whole and the production of new kinds of materials are closely associated with analytical chemistry. Analytical chemistry consists of classical, wet chemical methods and modern instrumental methods.

2.2 Analysis : Analysis is carried out on a small sample of the material to be tested, and not on the entire bulk. When the amount of a solid or liquid sample is a few grams, the analysis is called semi-microanalysis. It is of two types : **qualitative and quantitative**. Classical qualitative analysis methods include separations such as precipitation, extraction and distillation. Identification may be based on differences in colour, odour, melting point, boiling point, and reactivity. Classical quantitative methods consist of volumetric analysis, gravimetric analysis, etc.

2.2.1 Chemical methods of qualitative analysis : Chemical analysis of a sample is carried out mainly in two stages : by the dry method in which the sample under test is not dissolved and by the wet method in which the sample under test is first dissolved and then analyzed to determine its composition. The dry method is usually used as preliminary tests in the qualitative analysis.

The semi-micro qualitative analysis is carried out using apparatus such as : test tubes, beakers, evaporating dish, crucible, spot plate, watch glass, wire gauze, water bath, burner, blow pipe, pair of tongs, centrifuge, etc.

The qualitative analysis of **organic** and **inorganic** compounds involves **different** types of **tests**. The majority of organic compounds are composed of a relatively small number of elements. The most important ones are : carbon, hydrogen, oxygen, nitrogen, sulphur, halogen, phosphorous. Elementary qualitative analysis is concerned with the detection of the presence of these elements. The identification of an organic compound involves tests such as detection of functional group, determination of melting/ boiling point, etc. The qualitative analysis of simple inorganic compounds involves detection and confirmation of cationic

and anionic species (basic and acidic radical) in them.

2.2.2 Chemical methods of quantitative analysis :

Quantitative analysis of organic compounds involves methods such as (i) determination of percentage constituent element, (ii) concentrations of a known compound in the given sample, etc. Quantitative analysis of simple inorganic compounds involves methods based on (i) decomposition reaction (gravimetric analysis), and (ii) the progress of reaction between two solutions till its completion (titrametric or volumetric analysis), etc. The quantitative analytical methods involve measurement of quantities such as mass and volume, by mean of some equipment/ apparatus such as weighing machine, burette.

2.3 Mathematical operation and error analysis :

The accuracy of measurement is of a great concern in analytical chemistry. Also there can be intrinsic errors in the analytical measurement. The numerical data, obtained experimentally, are treated mathematically to reach some quantitative conclusion. Therefore, an analytical chemist has to know how to report the quantitative analytical data, indicating the extent of the accuracy of measurement, perform the mathematical operation and properly express the quantitative error in the result. In the following subsection we will consider these aspects related to measurements and calculation.

2.3.2 Scientific notation (exponential notation) :

A chemist has to deal with numbers as large as 602,200,000,000, 000, 000, 000, 000 for the molecules of 2 g of hydrogen gas or as small as 0.00000000000000000000000166g. that is, mass of a H atom. To avoid the writing of so many zeros in mathematical operations, scientific notations i.e. exponential notations are used. Here, any number can be represented into a form $N \times 10^n$ where 'n' is an exponent having positive or negative values and N can vary between 1 to 10. Thus, we can write the

above values as 6.022×10^{23} and 1.66×10^{-24} g. The number 123.546 becomes 1.23546×10^2 , in scientific notation. Note that while writing it, we have moved the decimal to the left by two places and same is the exponent (2) of 10 in the scientific notation. Similarly, 0.00015 can be written as 1.5×10^{-4} .

Problem 2.1 : For adding 5.55×10^4 and 6.95×10^3 , first the exponent is made equal. Thus

$5.55 \times 10^4 + 0.695 \times 10^4$. Then these numbers can be added as follows :

$$(5.55 + 0.695) \times 10^4 = 6.245 \times 10^4$$

Problem 2.2 : The subtraction of two numbers can be done as shown below:

$$\begin{aligned} & 3.5 \times 10^{-2} - 5.8 \times 10^{-3} \\ &= (3.5 \times 10^{-2}) - (0.58 \times 10^{-2}) \\ &= (3.5 - 0.58) \times 10^{-2} \\ &= 2.92 \times 10^{-2} \end{aligned}$$

Here the decimal has to be moved four places to the right and (-4) is the exponent in the scientific notation. Now let us perform mathematical operations on numbers expressed in scientific notation.

Problem 2.3 : $(5.6 \times 10^5) \times (6.9 \times 10^8)$

$$\begin{aligned} &= (5.6 \times 6.9) (10^{5+8}) \\ &= (5.6 \times 6.9) \times 10^{13} \\ &= 38.64 \times 10^{13} \\ &= 3.864 \times 10^{14} \end{aligned}$$

Problem 2.4 : $(9.8 \times 10^{-2}) \times (2.5 \times 10^{-6})$

$$\begin{aligned} &= (9.8 \times 2.5) (10^{-2+(-6)}) \\ &= (9.8 \times 2.5) \times 10^{-2-6} \\ &= 24.50 \times 10^{-8} \\ &= 2.45 \times 10^{-7} \end{aligned}$$

Addition and subtraction : To perform addition operation, first the numbers are written in such a way that they have the same exponent. The coefficients are then added. (Problems 2.1 and 2.2)

Multiplication : The rule for the multiplication of exponential numbers can be well explained from the solved problems 2.3 and 2.4.

2.3.2 Precision and accuracy of measurement

Aim of any measurement is to get the actual value called true value or accepted value of a quantity. Nearness of the measured value to the true value is called the accuracy of measurement. Larger the accuracy smaller the error. Accuracy depends upon the sensitivity or least count (the smallest quantity that can be measured) of the measuring equipment. consider, for example, a burette reading of 10.2 mL. For all the three situations in the Fig. 2.1 the reading would be noted is 10.2 mL It means that there is an uncertainty about the digit appearing after the decimal point in the reading 10.2 mL. This is because the least count of the burette is 0.1 mL. The meaning of the reading 10.2 mL is that the true value of the reading lies between 10.1 mL and 10.3 mL. This is indicated by writing 10.2 ± 0.1 mL. Here, the burette reading has an error of ± 0.1 mL (Fig. 2.1).

Errors may be expressed as **absolute** or **relative error**.

Absolute error = Observed value - True value

Relative error is generally a more useful quantity than absolute error. Relative error is the ratio of an absolute error to the true value. It is expressed as a percentage.

$$\text{Relative error} = \frac{\text{Absolute error}}{\text{True value}} \times 100 \%$$

There can be error in a measurement due to a number of reasons including inefficiency of the person doing measurement.

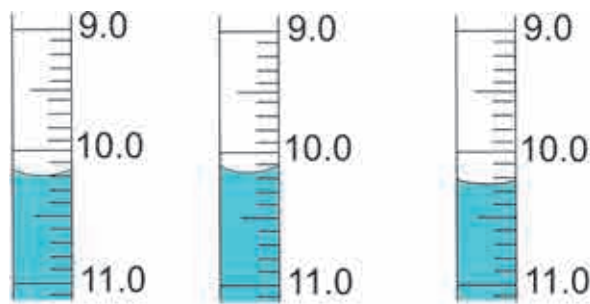

Fig. 2.1 : Three possibilities of a burette reading 10.2 mL

Multiple readings of the same quantity are noted to minimize the error. If the readings match closely, they are said to have high precision. High precision implies reproducibility of the readings. **High precision is a prerequisite for high accuracy.** Precision is expressed in terms of deviation. An absolute deviation is the modulus of the difference between an observed value and the arithmetic mean for the set of several measurements made in the same way. It is a measure of absolute error in the repeated observation.

$$\text{Absolute deviation} = |\text{Observed value} - \text{Mean}|$$

Arithmetic mean of all the absolute deviations is called the mean absolute deviation in the measurements. The ratio of mean absolute deviation to its arithmetic means is called relative deviation.

Relative deviation

$$= \frac{\text{Mean absolute deviation}}{\text{Mean}} \times 100 \%$$

Problem 2.5 : In laboratory experiment, 10 g potassium chlorate sample on decomposition gives following data ; The sample contains 3.8 g of oxygen and the actual mass of oxygen in the quantity of potassium chlorate is 3.92 g. Calculate absolute error and relative error.

Solution : The observed is 3.8 g and accepted value is 3.92 g

$$\begin{aligned} \text{Absolute error} &= \text{Observed value} \\ &\quad - \text{True value} \\ &= 3.8 - 3.92 = -0.12 \text{ g} \end{aligned}$$

The negative sign indicates that your experimental result is lower than the true value.

$$\begin{aligned} \text{The relative error} &= \frac{\text{Absolute error}}{\text{True value}} \times 100\% \\ &= \frac{-0.12}{3.92} \times 100\% \\ &= -3.06 \% \end{aligned}$$

Problem 2.6 : The three identical samples of potassium chlorate are decomposed. The mass of oxygen is determined to be 3.87 g, 3.95 g and 3.89 g for the set. Calculate absolute deviation and relative deviation.

Solution :

$$\text{mean} = \frac{3.87 + 3.95 + 3.89}{3} = 3.90$$

Average deviation of a set of measurements		
Sample	Mass of oxygen	Deviation
1	3.87g	0.03g
2	3.95g	0.05g
3	3.89g	0.01g
Mean absolute deviation		0.03

Absolute deviation

$$= |\text{Observed value} - \text{Mean}|$$

∴ Mean absolute deviation = ± 0.03 g.

The relative deviation,

$$= \frac{\text{Mean absolute deviation}}{\text{Mean}} \times 100\%$$

$$= \frac{0.03}{3.9} \times 100\% = 0.8\%$$

2.3.3 Significant Figures : Uncertainty in measured value leads to uncertainty in calculated result. Uncertainty in a value is indicated by mentioning the number of significant figures in that value. Consider, the column reading 10.2 ± 0.1 mL recorded on a burette having the least count of 0.1 mL. Here it is said that the last digit '2' in the reading is uncertain, its uncertainty is ± 0.1 mL. On the other hand, the figure '10' is certain. The significant figures in a measurement or result are the number of digits known with certainty plus one uncertain digit. In a scientific experiment a result is obtained by doing calculation in which values of a number of quantities measured with equipment of different least counts are used.

Following rules are to be followed during such calculation.

2.3.4 Rules for deciding significant figures :

- All non zero digits are significant; e. g. 127.34 g contains five significant figures which are 1, 2, 7, 3 and 4.
- All zeros between two non zero digits are significant e. g. 120.007 m contains six significant figures.
- Zeros on the left of the first non zero digit are not significant. Such a zero indicates the position of the decimal point. For example, 0.025 has two significant figures, 0.005 has one significant figure.
- Zeros at the end of a number are significant if they are on the right side of the decimal point. Terminal zeros are not significant if there is no decimal point. (This is because the least count of an instrument contains decimal point) For example 0.400 g has three significant figures. The measurements here indicates that it is made on a weighing machine having least count of 0.001 g. Significant figures are also indicated in scientific notation by means of decimal point. For example, the measurement 400 g has one significant figure. The measurement 4.0×10^2 g has two significant figures, whereas the measurement 4.00×10^2 g has three significant figures. The zeros after the decimal points in these cases indicates that the least counts of the weighing machines are 1 g, 0.1 g and 0.01 g, respectively.
- In numbers written in scientific notation, all digits are significant. For example, 2.035×10^2 has four significant figures, and 3.25×10^{-5} has three significant figures.

Problem 2.7 : How many significant figures are present in the following measurements ?

- a. 4.065 m b. 0.32 g c. 57.98 cm³
 d. 0.02 s e. 4.0×10^{-4} km
 f. 604.0820 kg g. 307.100×10^{-5} cm

Ans. : a. 4 b. 2 c. 4 d. 1
 e. 2 f. 7 g. 6

In general, a quantity measured with an instrument of smaller least count will have more significant figures and will be more accurate than when measured with an instrument of larger least count.

2.3.5 Calculations with significant figures :

When performing calculations with measured quantities the rule is that the accuracy of the final result is limited to the accuracy of the least accurate measurement. In other words, the final result can not be more accurate than the least accurate number involved in the calculation.

Rounding off : The final result of a calculation often contains figures that are not significant. When this occurs the final result is rounded off. The following rules are used to round off a number to the required number of significant figures :

If the digit following the last digit to be kept is less than five, the last digit is left unchanged.

e.g. 46.32 rounded off to two significant figures is 46.

If the digit following the last digit to be kept is five or more, the last digit to be kept is increased by one. e.g. 52.87 rounded to three significant figures is 52.9.

Problem 2.8 : Round off each of the following to the number of significant digits indicated :

a. 1.223 to two digits b. 12.56 to three digits
c. 122.17 to four digits d. 231.5 to three digits.

Ans. : i. 1.2; the third digit is less than 5, so we drop it all the others to its right.

ii. 12.6; the fourth digit is greater than 5, so we drop it and add 1 to the third digit.

iii. 122.2; the fifth digit is greater than 5, so we do it and add 1 to the fourth digit.

iv. 232; the fourth digit is 5, so we drop it and add 1 to the third digit.

2.4 Determination of molecular formula :

Molecular formula of a compound is the formula which indicates the actual number of atoms of the constituent elements in a molecule. It can be obtained from the experimentally determined values of percent elemental composition and molar mass of that compound.

2.4.1 Percent composition and empirical formula :

Compounds are formed by chemical combination of different elements. Quantitative determination of the constituent element by suitable methods provides the percent elemental composition of a compound. If the percent total is not 100, the difference is considered as percent oxygen. From the the per cent composition, the ratio of the atoms of the constituent elements in the molecule is calculated. **The simplest ratio of atoms of the constituent elements in a molecule is called the empirical formula of that compound.** Molecular formula can be obtained from the empirical formula if the molar mass is known. The molar mass of the substance under examination is determined by some convenient method. The following example illustrates this sequence.

Problem 2.9 : A compound contains 4.07 % hydrogen, 24.27% carbon and 71.65 % chlorine by mass. Its molar mass is 98.96 g. What is its empirical formula ? Atomic masses of hydrogen, carbon and chlorine are 1.008, 12.000 and 35.453 u, respectively

Solution :

Step I : Check whether the sum of all the percentages is 100.

$$4.07 + 24.27 + 71.65 = 99.99 \approx 100$$

Therefore no need to consider presence of oxygen atom in the molecule.

Step II : Conversion of mass percent to grams. Since we are having mass percent, it is convenient to use 100 g of the compound as the starting material. Thus in the 100 g sample of the above compound, 4.07 g hydrogen 24.27 g carbon and 71.65 g chlorine is present..... Contd on next page

Step III : Convert into number/of moles of each element. Divide the masses obtained above by respective atomic masses of various elements.

$$\text{Moles of hydrogen} = \frac{4.07 \text{ g}}{1.008 \text{ g}} = 4.04$$

$$\text{Moles of carbons} = \frac{24.27 \text{ g}}{12.01 \text{ g}} = 2.0225$$

$$\text{Moles of chlorine} = \frac{71.65 \text{ g}}{35.453 \text{ g}} = 2.021$$

Steps IV : Divide the mole values obtained above by the smallest value among them.

Since 2.021 is smallest value, division by it gives a ratio of 2:1:1 for H:C:Cl.

In case the ratio are not whole numbers, then they may be converted into whole number by multiplying by the suitable coefficient.

Step V : Write empirical formula by mentioning the numbers after writing the symbols of respective elements. CH_2Cl is thus, the empirical formula of the above compound.

Step VI : Writing molecular formula

a. Determine empirical formula mass : Add the atomic masses of various atoms present in the empirical formula.

For CH_2Cl , empirical formula mass is

$$12.01 + 2 \times 1.008 + 35.453$$

$$= 49.48 \text{ g}$$

b. Divide molar mass by empirical formula mass

$$\therefore \frac{\text{Molar mass}}{\text{Empirical formula mass}} = \frac{98.96 \text{ g}}{49.48 \text{ g}}$$

$$\therefore r = 2$$

c. multiply empirical formula by r obtained above to get the molecular formula.

Molecular formula = r x empirical formula
molecular formula is 2 x CH_2Cl i.e. $\text{C}_2\text{H}_4\text{Cl}_2$.

Problem 2.10 : A compound with molar mass 159 was found to contain 39.62 % copper and 20.13 % sulfur. Suggest molecular formula for the compound (Atomic masses: Cu = 63, S = 32 and O = 16).

Solution :

$$\begin{aligned} \% \text{ copper} + \% \text{ sulfur} &= 39.62 + 20.13 \\ &= 59.75 \end{aligned}$$

This is less than 100 % Hence compound contains adequate oxygen so that the total percentage of elements is 100%.

$$\text{Hence \% of oxygen} = 100 - 59.75 = 40.25\%$$

$$\text{Moles of Cu} = \frac{\% \text{ of Cu}}{\text{Atomic mass of Cu}}$$

$$= \frac{39.62}{63} = 0.629$$

$$\text{Moles of S} = \frac{\% \text{ of S}}{\text{Atomic mass of S}}$$

$$= \frac{20.13}{32} = 0.629$$

$$\text{Moles of O} = \frac{\% \text{ of O}}{\text{Atomic mass of O}} = \frac{40.25}{16} = 2.516$$

Hence the ratio of number of moles of Cu:S:O is

$$\frac{0.629}{0.629} = 1 \quad \frac{0.629}{0.629} = 1 \quad \text{and} \quad \frac{2.516}{0.629} = 4$$

Hence empirical formula is CuSO_4

Empirical formula mass

$$= 63 + 32 + 16 \times 4 = 159$$

Molar mass = Empirical mass (Since Molar mass = Molecular mass)

$$\therefore \text{Molecular formula} = \text{Empirical formula} = \text{CuSO}_4$$

2.5 Chemical reactions and stoichiometric calculations

Calculation based on a balanced chemical equations are known as stoichiometric calculations.

Balanced chemical equation is symbolic representation of a chemical reaction. It supplies the following information which is useful in solving problems based on chemical equations

- It indicates the number of moles of the reactants involved in a chemical reaction and the number of moles of the products formed.

- ii. It indicates the relative masses of the reactants and products linked with a chemical change, and
- iii. it indicates the relationship between the volume/s of the gaseous reactants and products, at STP.

2.5.1 Stoichiometric problems

Generally problems based on stoichiometry are of the following types :

- a. Problems based on mass-mass relationship;
- b. Problems based on mass-volume relationship and
- c. Problems based on volume-volume relationship.

Steps involved in problems based on stoichiometric calculations :

1. Write down the balanced chemical equation representing the chemical reaction.
2. Write the number of moles and the relative masses or volumes of the reactants and products below the respective formulae.
3. Relative masses or volumes should be calculated from the respective formula mass referring to the condition of STP.
4. Apply the unitary method to calculate the unknown factor/s as required by the problem.

Problem 2.11 : Calculate the mass of carbon dioxide and water formed on complete combustion of 24 g of methane gas. (Atomic masses, C = 12 u, H = 1 u, O = 16 u)

Solution : The balanced chemical equation is,

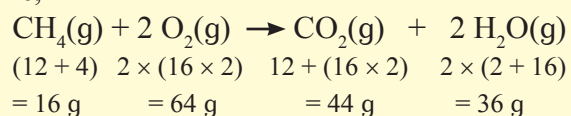

Hence, 16 g of CH₄ on complete combustion will produce 44 g of CO₂

$$\therefore 24 \text{ g of CH}_4 = \frac{24}{16} \times 44 = 66 \text{ g of CO}_2$$

Similarly, 16 g of CH₄ will produce 36 g of water.

$$24 \text{ g of CH}_4 = \frac{24}{16} \times 36 = 54 \text{ g water.}$$

Problem 2.12 : How much CaO will be produced by decomposition of 5g CaCO₃ ?

Solution : Calcium carbonate decomposes according to the balanced equation,

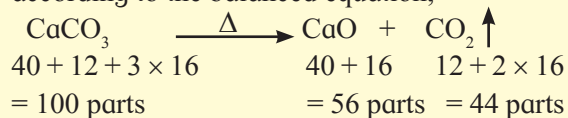

So, 100 g of CaCO₃ produces 56 g of CaO

∴ 5 g of CaCO₃ will produce

$$= \frac{56 \text{ g}}{100 \text{ g}} \times 5 \text{ g} = 2.8 \text{ g of CaCO}_3$$

Problem 2.13 : How many litres of oxygen at STP are required to burn completely 2.2 g of propane, C₃H₈ ?

Solution : The balanced chemical equation for the combustion of propane is,

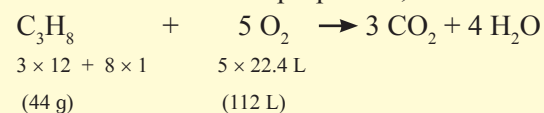

(Where 1 mol of ideal gas occupies 22.4 L of volume)

Thus 44 g of propane requires 112 litres of oxygen for complete combustion

∴ 2.2 g of propane will require

$$\frac{112}{44} \times 2.2 = 5.6 \text{ litres of O}_2 \text{ at STP for complete combustion.}$$

Problem 2.14 : A piece of zinc weighing 0.635 g when treated with excess of dilute H₂SO₄ liberated 200 cm³ of hydrogen at STP. Calculate the percentage purity of the zinc sample.

Solution : The relevant balanced chemical equation is,

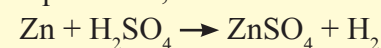

It indicates that 22.4 L of hydrogen at STP = 65 g of Zn.

(where Atomic mass of Zn = 65 u)

∴ 0.200 L of hydrogen at STP

$$= \frac{65 \text{ g}}{22.4 \text{ L}} \times 0.200 \text{ L} = 0.58 \text{ g}$$

$$\therefore \text{percentage purity of Zn} = \frac{0.58}{0.635} \times 100 = 91.33 \%$$

2.6 Limiting reagent

When a chemist carries out a reaction, the reactants are not usually present in exact stoichiometric amounts, that is, in the proportions indicated by the balanced equation. Because the goal of a reaction is to produce the maximum quantity of a useful compound from the starting materials, frequently, a large excess of one reactant is supplied to ensure that the more expensive reactant is completely converted into the desired product. The reactant which is present in lesser amount gets consumed after some time and subsequently, no further reaction takes place, whatever be the amount left of the other reactant present. Hence, the reactant which gets consumed, limits the amount of product formed and is therefore, called the **limiting reagent**.

Consider the formation of nitrogen dioxide (NO_2) from nitric oxide (NO) and oxygen

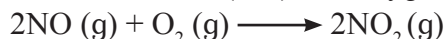

Suppose initially we have 8 moles of NO and 7 moles of O_2 . One way to determine which of the two reactants is the limiting reagent is to calculate the number of moles NO_2 obtainable from the given initial quantities of NO and O_2 .

From the preceding definition, we see that the limiting reagent will yield the smaller amount of the product. Starting with 8 moles of NO , we find the number of moles of NO_2 produced is

$$8 \text{ mol NO} \times \frac{2 \text{ mol NO}_2}{2 \text{ mol NO}} = 8 \text{ mol NO}_2$$

and starting with 7 moles of O_2 , the number of moles NO_2 formed is

$$7 \text{ mol O}_2 \times \frac{2 \text{ mol NO}_2}{1 \text{ mol O}_2} = 14 \text{ mol NO}_2$$

Because 8 moles NO result in a smaller amount of NO_2 , NO must be the limiting reagent, and O_2 is the excess reagent, before reaction has started.

Problem 2.15: Urea [$(\text{NH}_2)_2\text{CO}$] is prepared by reacting ammonia with carbon dioxide.

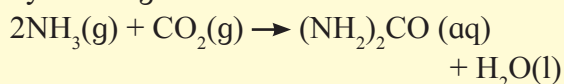

In one process, 637.2 g of NH_3 are

treated with 1142 g of CO_2 . (a) Which of the two reactants is the limiting reagent? (b) Calculate the mass of $(\text{NH}_2)_2\text{CO}$ formed. (c) How much excess reagent (in grams) is left at the end of the reaction?

Solution: (a) We carry out two separate calculations. First: If 637.2 g of NH_3 reacts completely, calculate the number of moles of $(\text{NH}_2)_2\text{CO}$, that could be produced, by the following relation.

$$\begin{aligned} \text{mass of NH}_3 &\longrightarrow \text{moles of NH}_3 \\ &\longrightarrow \text{moles of (NH}_2)_2\text{CO} \\ \text{moles of (NH}_2)_2\text{CO} &= 637.2 \text{ g NH}_3 \\ &\times \frac{1 \text{ mol NH}_3}{17.03 \text{ g NH}_3} \times \frac{1 \text{ mol (NH}_2)_2\text{CO}}{2 \text{ mol NH}_3} \\ &= 18.71 \text{ moles (NH}_2)_2\text{CO} \end{aligned}$$

Second: The relation from 1142 g of CO_2 :
 $\text{mass of CO}_2 \longrightarrow \text{moles of CO}_2 \longrightarrow \text{moles of (NH}_2)_2\text{CO}$

The number of moles of $(\text{NH}_2)_2\text{CO}$ that could be produced if all the CO_2 reacted:

$$\begin{aligned} \text{moles of (NH}_2)_2\text{CO} &= 1142 \text{ g CO}_2 \\ &\times \frac{1 \text{ mol CO}_2}{44.01 \text{ g CO}_2} \times \frac{1 \text{ mol (NH}_2)_2\text{CO}}{1 \text{ mol CO}_2} \\ &= 25.95 \text{ mol (NH}_2)_2\text{CO} \end{aligned}$$

It follows, therefore, that NH_3 must be the limiting reagent because it produces (a) smaller amount of $(\text{NH}_2)_2\text{CO}$ (b) The molar mass of $(\text{NH}_2)_2\text{CO}$ is 60.06 g. We use this as a conversion factor to convert from moles of $(\text{NH}_2)_2\text{CO}$ to grams of $(\text{NH}_2)_2\text{CO}$.

$$\begin{aligned} \text{mass of (NH}_2)_2\text{CO} &= 18.71 \text{ mol (NH}_2)_2\text{CO} \\ &\times \frac{60.06 \text{ g (NH}_2)_2\text{CO}}{1 \text{ mol}} \\ \therefore &= 1124 \text{ g (NH}_2)_2\text{CO} \end{aligned}$$

(c) Starting with 18.71 moles of $(\text{NH}_2)_2\text{CO}$, we can determine the mass of CO_2 that reacted using the mole ratio from the balanced equation and the molar mass of CO_2 Contd. on next page

The conversion steps are
 moles of $(\text{NH}_2)_2\text{CO} \longrightarrow$ moles of CO_2
 \longrightarrow grams of CO_2

So that,

mass of CO_2 reacted

$$= 18.71 \text{ mol } (\text{NH}_2)_2\text{CO}$$

$$\times \frac{1 \text{ mol } \text{CO}_2}{1 \text{ mol } (\text{NH}_2)_2\text{CO}} \times \frac{44.01 \text{ g } \text{CO}_2}{1 \text{ mol } \text{CO}_2}$$

$$= 823.4 \text{ g}$$

The amount of CO_2 remaining (in excess)

is the difference between the initial amount (1142 g) and the amount reacted (823.4 g):

$$\text{mass of } \text{CO}_2 \text{ remaining} = 1142 \text{ g} - 823.4 \text{ g} \\ = 318.6 \text{ g} \approx 319 \text{ g}$$

2.7 Concentration of solution : A majority of reactions in the laboratory are carried out in solutions. Therefore, it is important to understand how the amount of substance is expressed when it is present in the form of a solution. The concentration of a solution or the amount of substance present in given volume of a solution can be expressed in any of the following ways :

1. Mass percent or weight percent (w/w %)
2. Mole fraction
3. Molarity (M)
4. Molality (m)

2.7.1 Mass percent : It is obtained by using following relation:

$$\text{Mass percent} = \frac{\text{Mass of solute}}{\text{Mass of solution}} \times 100 \%$$

Problem 2.16 : A solution is prepared by adding 2 g of a substance A to 18 g of water. Calculate the mass percent of the solute.

Solution : Mass percent of

$$A = \frac{\text{Mass of A}}{\text{Mass of solution}} \times 100 \\ = \frac{2 \text{ g}}{2 \text{ g of A} + 18 \text{ g of water}} \times 100 \\ = \frac{2 \text{ g}}{20 \text{ g}} \times 100 = 10 \%$$

2.7.2 Mole fraction

It is the ratio of number of moles of a particular component of a solution to the total number of moles of the solution. If a substance 'A' dissolves in substance 'B' and their number of moles are n_A and n_B , respectively, then the mole fraction of A and B are given as :

$$\text{Mole fraction of A} = \frac{\text{No. of moles of A}}{\text{No. of moles of solution}}$$

$$\therefore \text{Mole fraction of A} = \frac{n_A}{n_A + n_B}$$

$$\text{Mole fraction of B} = \frac{\text{No. of moles of B}}{\text{No. of moles of solution}}$$

$$= \frac{n_B}{n_A + n_B}$$

2.7.3 Molarity

It is the most widely used unit and is denoted by M. It is defined as the number of moles of the solute present in 1 litre of the solution. Thus,

$$\text{Molarity (M)} = \frac{\text{No. of moles of solute}}{\text{Volume of solution in litres}}$$

Problem 2.17 : Calculate the molarity of NaOH in the solution prepared by dissolving its 4 g in enough water to form 250 mL of the solution.

Solution :

Since molarity (M) =

$$\frac{\text{No. of moles of solute}}{\text{Volume of solution in litres}}$$

$\therefore M =$

$$\frac{\text{Mass of NaOH} / \text{Molar mass of NaOH}}{0.250 \text{ L}}$$

$$\therefore M = \frac{4 \text{ g} / 40 \text{ g}}{0.250 \text{ L}}$$

$$\therefore M = \frac{0.1 \text{ mol}}{0.250 \text{ L}}$$

$$\therefore M = 0.4 \text{ mol L}^{-1} = 0.4 \text{ M}$$

Note that molarity of a solution depends upon temperature because volume of a solution is temperature dependent.

2.7.4 Molality

It is defined as the number of moles of solute present in 1 kg of solvent. It is denoted by m .

$$\text{Molality (m)} = \frac{\text{No. of moles of solute}}{\text{Mass of solvent in kg}}$$

Note that molality of a solution does not change with temperature since mass remains unaffected with temperature. Often in chemistry laboratory, a solution of desired concentration is prepared by diluting a solution of known higher concentration. The solution of higher concentration is also known as stock solution.

Problem 2.18 : The density of 3M solution of NaCl is 1.25 g mL^{-1} . Calculate molality of the solution.

Solution : Molarity = 3 mol L^{-1}

$$\begin{aligned} \text{Mass of NaCl in 1 L solution} &= 3 \times 58.5 \\ \therefore &= 175.5 \text{ g} \end{aligned}$$

$$\begin{aligned} \text{Mass of 1L solution} &= 1000 \times 1.25 = 1250 \text{ g} \\ (\because \text{density} &= 1.25 \text{ g mL}^{-1}) \end{aligned}$$

$$\begin{aligned} \text{Mass of water in solution} &= 1250 - 175.5 \\ \therefore &= 1074.5 \text{ g} \end{aligned}$$

$$\begin{aligned} \text{Molality} &= \frac{\text{No. of moles of solute}}{\text{Mass of solvent in kg}} \\ &= \frac{3 \text{ mol}}{1.0745 \text{ kg}} = 2.79 \text{ m} \end{aligned}$$

2.8 Use of graph in analysis : Analytical chemistry also involves deducing some relation, if any, between two or more properties of matter under study. One of the classic example in the relation between temperature and volume of a given amount of gas. A set of experimentally measured values of volume and temperature of a definite mass of a gas upon plotting on a graph paper appeared as in the figure (Fig. 2.2 (a)). When the points are directly connected, a zig zag pattern results (Fig. 2.2 (b)). From this pattern no meaningful result can be deduced. A zig zag pattern results due to many types of errors that incur in many measurements involved an experiment. Figure 2.2 (c) shows a smooth curve which may be called an average curve passing through these

points. In the above example it happens to be straight line and the inference is that $V \propto T$.

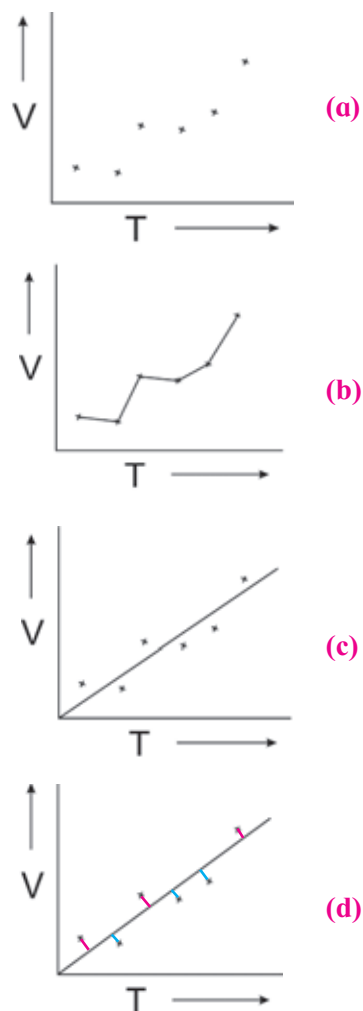

Fig. 2.2 : Drawing an average curve through the points on graph

While fitting it to a smooth curve, care is taken that the plotted points are evenly distributed about it. Mathematically ‘even distribution’ is understood as follows :

From each point draw a perpendicular to the curve. The perpendicular represents deviation of each point from the curve (Fig 2.2 (d)). The positive deviations are shown in red and negative deviations are shown in blue. Take sum of all the red perpendiculars and all the blue perpendiculars separately. If the two sums are equal (or nearly equal) the curve drawn shows the experimental points in the best possible representation.



Exercises

1. Choose correct option

- A. The branch of chemistry which deals with study of separation, identification, and quantitative determination of the composition of different substances is called as
- Physical chemistry
 - Inorganic chemistry
 - Organic chemistry
 - Analytical chemistry
- B. Which one of the following property of matter is Not quantitative in nature ?
- Mass
 - Length
 - Colour
 - Volume
- C. SI unit of mass is
- kg
 - mol
 - pound
 - m^3
- D. The number of significant figures in 1.50×10^4 g is
- 2
 - 3
 - 4
 - 6
- E. In Avogadro's constant $6.022 \times 10^{23} \text{ mol}^{-1}$, the number of significant figures is
- 3
 - 4
 - 5
 - 6
- F. By decomposition of 25 g of CaCO_3 , the amount of CaO produced will be
- 2.8 g
 - 8.4 g
 - 14.0 g
 - 28.0 g
- G. How many grams of water will be produced by complete combustion of 12 g of methane gas
- 16
 - 27
 - 36
 - 56
- H. Two elements A (At. mass 75) and B (At. mass 16) combine to give a compound having 75.8 % of A. The formula of the compound is
- AB
 - A_2B
 - AB_2
 - A_2B_3
- I. The hydrocarbon contains 79.87 % carbon and 20.13 % of hydrogen. What is its empirical formula ?
- CH
 - CH_2
 - CH_3
 - C_2H_5
- J. How many grams of oxygen will be required to react completely with 27 g of Al? (Atomic mass : Al = 27, O = 16)
- 8
 - 16
 - 24
 - 32
- K. In $\text{CuSO}_4 \cdot 5\text{H}_2\text{O}$ the percentage of water is
- (Cu = 63.5, S = 32, O = 16, H = 1)
- 10 %
 - 36 %
 - 60 %
 - 72 %
- L. When two properties of a system are mathematically related to each other, the relation can be deduced by
- Working out mean deviation
 - Plotting a graph
 - Calculating relative error
 - all the above three

2. Answer the following questions

- Define : Least count
- What do you mean by significant figures? State the rules for deciding significant figures.
- Distinguish between accuracy and precision.
- Explain the terms percentage composition, empirical formula and molecular formula.
- What is a limiting reagent ? Explain.
- What do you mean by SI units ? What is the SI unit of mass ?
- Explain the following terms
 - Mole fraction
 - Molarity
 - Molality
- Define : Stoichiometry
- Why there is a need of rounding off figures during calculation ?
- Why does molarity of a solution depend upon temperature ?

M. Define Analytical chemistry. Why is accurate measurement crucial in science?

3. Solve the following questions

A. How many significant figures are in each of the following quantities ?

- a. 45.26 ft b. 0.109 in
c. 0.00025 kg d. 2.3659×10^{-8} cm
e. 52.0 cm³ f. 0.00020 kg
g. 8.50×10^4 mm h. 300.0 cg

B. Round off each of the following quantities to two significant figures :

- a. 25.55 mL b. 0.00254 m
c. 1.491×10^5 mg d. 199 g

C. Round off each of the following quantities to three significant figures :

- a. 1.43 cm³ b. 458×10^2 cm
c. 643 cm² d. 0.039 m
e. 6.398×10^{-3} km
f. 0.0179 g g. 79,000 m
h. 42,150 i. 649.85;
j. 23,642,000 mm
k. 0.0041962 kg

D. Express the following sum to appropriate number of significant figures :

- a. 2.3×10^3 mL + 4.22×10^4 mL + 9.04×10^3 mL + 8.71×10^5 mL;
b. 319.5 g - 20460 g - 0.0639 g - 45.642 g - 4.173 g

4. Solve the following problems

A. Express the following quantities in exponential terms.

- a. 0.0003498 b. 235.4678
c. 70000.0 d. 1569.00

B. Give the number of significant figures in each of the following

- a. 1.230×10^4 b. 0.002030
c. 1.23×10^4 d. 1.89×10^{-4}

C. Express the quantities in above (B) with or without exponents as the case may be.

D. Find out the molar masses of the following compounds :

- a. Copper sulphate crystal ($\text{CuSO}_4 \cdot 5\text{H}_2\text{O}$)
(Ans.: 249.5 g/mol)

b. Sodium carbonate, decahydrate ($\text{Na}_2\text{CO}_3 \cdot 10\text{H}_2\text{O}$)

(Ans.: 286 g/mol)

c. Mohr's salt [$\text{FeSO}_4(\text{NH}_4)_2\text{SO}_4 \cdot 6\text{H}_2\text{O}$]

(Ans.: 392 g/mol)

(At. mass : Cu = 63.5; S = 32; O = 16; H = 1; Na = 23; C = 12; Fe = 56; N = 14)

E. Work out the percentage composition of constituents elements in the following compounds :

- a. Lead phosphate [$\text{Pb}_3(\text{PO}_4)_2$],
b. Potassium dichromate ($\text{K}_2\text{Cr}_2\text{O}_7$),
c. Macrocosmic salt - Sodium ammonium hydrogen phosphate, tetrahydrate ($\text{NaNH}_4\text{HPO}_4 \cdot 4\text{H}_2\text{O}$)
(At. mass : Pb = 207; P = 31; O = 16; K = 39; Cr = 52; Na = 23; N = 14)

F. Find the percentage composition of constituent green vitriol crystals ($\text{FeSO}_4 \cdot 7\text{H}_2\text{O}$). Also find out the mass of iron and the water of crystallisation in 4.54 kg of the crystals. (At. mass : Fe = 56; S = 32; O = 16)

(Ans.: mass of Fe = 0.915 kg,
mass of $7\text{H}_2\text{O}$ = 2.058 kg)

G. The red colour of blood is due to a compound called "haemoglobin". It contains 0.335 % of iron. Four atoms of iron are present in one molecule of haemoglobin. What is its molecular weight ? (At. mass : Fe 55.84)

(Ans.: 66674.6 g/mol)

H. A substance, on analysis, gave the following percent composition: Na = 43.4 %, C = 11.3 % and O = 45.3 %. Calculate the empirical formula. (At. mass Na = 23 u, C = 12 u, O = 16 u).

(Ans.: Na_2CO_3)

I. Assuming the atomic weight of a metal M to be 56, find the empirical formula of its oxide containing 70.0% of M.

(Ans.: M_2O_3)

J. 1.00 g of a hydrated salt contains 0.2014 g of iron, 0.1153 g of sulfur, 0.2301 g of oxygen and

0.4532 g of water of crystallisation. Find the empirical formula. (At. wt. : Fe = 56; S = 32; O = 16)

(Ans.: FeSO_4)

K. An organic compound containing oxygen, carbon, hydrogen and nitrogen contains 20 % carbon, 6.7 % hydrogen and 46.67 % nitrogen. Its molecular mass was found to be 60. Find the molecular formula of the compound.

(Ans.: $\text{CH}_4\text{N}_2\text{O}$)

L. A compound on analysis gave the following percentage composition by mass : H = 9.09; O = 36.36; C = 54.55. Mol mass of compound is 88. Find its molecular formula.

M. Carbohydrates are compounds containing only carbon, hydrogen and oxygen. When heated in the absence of air, these compounds decompose to form carbon and water. If 310 g of a carbohydrate leave a residue of 124 g of carbon on heating in absence of air, what is the empirical formula of the carbohydrate ?

(Ans.: CH_2O)

N. Write each of the following in exponential notation :

- a. 3,672,199 b. 0.000098
c. 0.00461 d. 198.75

O. Write each of the following numbers in ordinary decimal form :

- a. 3.49×10^{-11} b. 3.75×10^{-1}
c. 5.16×10^4 d. 43.71×10^{-4}
e. 0.011×10^{-3} f. 14.3×10^{-2}
g. 0.00477×10^5 h. 5.00858585

P. Perform each of the following calculations. Round off your answers to two digits.

a. $\frac{1}{3.40 \times 10^{24}}$; b. $\frac{33}{9.00 \times 10^{-4}}$;

c. $\frac{1.4 \times 10^9}{(2.77 \times 10^3)(3.76 \times 10^5)}$;

d. $\frac{(4 \times 10^{-3})(9.9 \times 10^{-7})}{(789)(1.002 \times 10^{-10})(0.3 \times 10^2)}$

Q. Perform each of the following calculations. Round off your answers to three digits.

a. (3.26 104) (1.54 106)

b. (8.39 107) (4.53 109)

c. $\frac{8.94 \times 10^6}{4.35 \times 10^4}$

d. $\frac{(9.28 \times 10^9)(9.9 \times 10^{-7})}{(511)(2.98 \times 10^{-6})}$

R. Perform the following operations :

a. $3.971 \times 10^7 + 1.98 \times 10^4$;

b. $1.05 \times 10^4 - 9.7 \times 10^{-5}$;

c. $4.11 \times 10^{-3} + 8.1 \times 10^{-4}$;

d. $2.12 \times 10^6 - 3.5 \times 10^5$.

S. A 1.000 mL sample of acetone, a common solvent used as a paint remover, was placed in a small bottle whose mass was known to be 38.0015 g. The following values were obtained when the acetone - filled bottle was weighed : 38.7798 g, 38.7795 g and 38.7801 g. How would you characterise the precision and accuracy of these measurements if the actual mass of the acetone was 0.7791 g ?

(Ans.: $\pm 0.07736\%$ 0.1027%)

T. Your laboratory partner was given the task of measuring the length of a box (approx 5 in) as accurately as possible, using a metre stick graduated in millimeters. He supplied you with the following measurements:

12.65 cm, 12.6 cm, 12.65 cm, 12.655 cm, 126.55 mm, 12 cm.

a. State which of the measurements you would accept, giving the reason.

(Ans.: 12.6 cm)

b. Give your reason for rejecting each of the others.

U. What weight of calcium oxide will be formed on heating 19.3 g of calcium carbonate ?

(At. wt. : Ca = 40; C = 12; O = 16)

(Ans. : 10.8 g)

V. The hourly energy requirements of an astronaut can be satisfied by the energy released when 34 grams of sucrose are “burnt” in his body. How many grams of oxygen would be needed to be carried in space capsule to meet his requirement for one day ?

(Ans. : 916.21 g)



Activity :

Collect information about various apparatus/instruments used in chemistry laboratory and make presentation of it in science exhibition.



Internet my friend

1. Error in chemical analysis

<https://chem.libretexts.org>>...>chapters

2. Collect information about Analytical chemistry.

3. Basic Analytical Techniques

3.1 Introduction

There has been a systematic development in the techniques used for analysis of chemical substances. In this chapter we are going to look into basic analytical techniques, namely, purification and separation techniques. Chemical substances occur in nature in impure stage. Also, when synthesized in the laboratory they are obtained in crude and impure form. Before investigating their composition and properties it is essential to obtain them in the pure form. Methods of purification and separation of compounds depend on the difference in their physical properties.

3.2 Purification of solids

A solid substance may contain two types of impurities, those (i) which are soluble in the same solvent as the main substance and (ii) which are not soluble in the same solvent as the substance. The second type of impurity can be separated easily using a suitable solvent to dissolve the main compound when the impurities remain undissolved and can be separated by a simple process called **filtration**. This process is similar to separating tea leaves from a decoction of tea, or sand from mixture of sand and water. Filtration is carried out with the help of a filter paper cone placed in a funnel as shown in the Fig. 3.1. A circular piece of filter paper is folded to form a cone and fitted in the funnel. The funnel is fixed on a stand and a beaker kept below it. The paper is made moist, the solution to be filtered is poured on the filter paper.

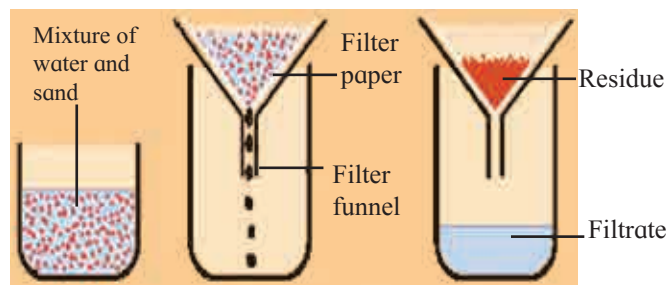

Fig. 3.1 : Separation of mixture of water and sand by simple filtration

The insoluble part remaining on the filter paper is called **residue** and the liquid collected in the beaker is called **filtrate**.

Filtration under suction : When filtration is carried out using a vacuum pump it is called filtration under suction. It is a faster and more efficient technique than simple filtration.

The assembly for filtration under suction consists of a thick wall conical flask with a side arm. The flask is connected to a safety bottle by rubber tube through the side arm. The safety bottle is used to prevent sucking of the filtrate into suction pump. A special porcelain funnel called Buchner funnel is fitted on the conical flask with the help of a rubber cork as shown in Fig. 3.2.

The Buchner funnel has a porous circular bottom. A circular filter paper of correct size is placed on the circular porous bottom of the Buchner funnel and the funnel is placed on the flask. It is moistened with a few drops of water or solvent. Suction is created by starting the pump and filtration is carried out. Crystals are collected on the filter paper and filtrate in the flask.

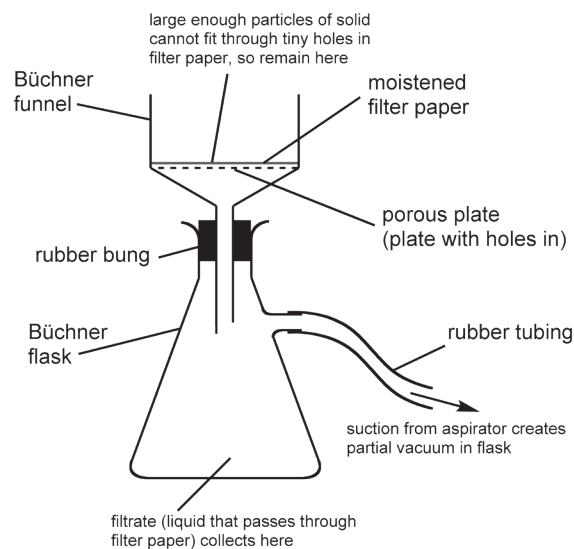

Fig. 3.2 : Setup for filtration under suction

3.2.1 Crystallization : When a crude solid is made of mainly one substance and has some impurities, it is purified by the process of crystallization. It is done in four steps:

(i) Preparation of saturated solution : A saturated solution is a solution which cannot dissolve additional quantity of solute. A saturated solution of the crude solid is prepared by boiling it in a small but sufficient quantity of a suitable solvent. On doing so the main solute forms an almost saturated solution, but the solution is not saturated with respect to the soluble impurities, as they are in small proportion.

(ii) Hot filtration : The above solution is quickly filtered while hot. Filtration under suction allows rapid filtration. Undissolved impurities get removed in this process as residue.

(iii) Cooling of the filtrate : The hot filtrate is allowed to cool. Solubility of a substance decreases with lowering of temperature. As a result, the filtrate becomes supersaturated with respect to the main dissolved solute. The excess quantity of the dissolved solute comes out of the solution in the form of crystals. The dissolved impurities, however, do not supersaturate the solution, as their quantity is small. These continue to stay in the solution in dissolved state even on cooling. The separated crystals are, therefore, free from soluble impurities as well.

(iv) Filtration : The crystals of the pure substance are separated by filtration. The filtrate obtained is called **mother liquor**. The crystals so formed are free from soluble as well as insoluble impurities.

Choice of the solvent : The solvent to be used for crystallization must have following properties :

1. The compound to be crystallized should be least or sparingly soluble in the solvent at room temperature but highly soluble at high temperature.
2. Solvent should not react chemically with the compound to be purified.
3. Solvent should be volatile so that it can be removed easily.

Water, ethyl alcohol, methyl alcohol, acetone, ether or their combinations are generally used as solvent for crystallization. The choice is done by trial and error method.

Activity : Crystallization of common salt from impure sample.

Many times the common salt obtained from the market may contain some siliceous matter and other impurities. These can be removed and larger crystals of pure NaCl can be obtained.

Apparatus : Beaker, glass rod, funnel, filter paper and stand, evaporating dish, etc.

Materials : Impure market salt or a mixture of salt and fine sand, etc.

Procedure : Arrange apparatus as shown in Fig. 3.3. Take some water in a beaker. Add salt to the beaker and stir it with a glass rod. Add more salt and stir till no more salt dissolves. Heat the solution. Filter the hot solution, insoluble impurities will remain on the filter paper. Collect the filtrate in an evaporating dish and allow to cool. Crystals of pure salt NaCl will separate leaving soluble impurities in the mother liquor. Filter the solution and collect the crystals on the filter paper and dry them.

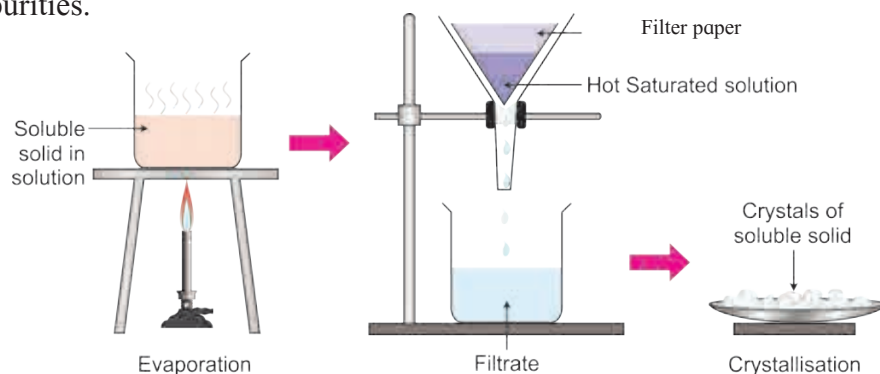

Fig. 3.3 : Process of crystallization

Impure copper sulphate can be purified by crystallization using water as solvent. Similarly, Benzoic acid can also be purified by crystallization using water as solvent.

3.2.2 Fractional crystallization :

Two or more substances in a mixture can be separated by fractional crystallisation process. Fractional crystallisation is a process wherein two or more soluble substances having widely different solubilities in the same solvent at room temperature are separated by crystallization.

Mixture of two solutes A and B are dissolved in a suitable hot solvent to prepare a saturated solution. The saturated solution is filtered to remove dust particles and then allowed to cool. As the solution cools, the solute which is less soluble crystallizes out first. The crystals are filtered, washed with solvent and dried. The mother liquor is concentrated by evaporating the solvent. The second solute crystallizes from the mother liquor. These crystals are filtered to obtain the separated and purified second component.

3.3 : Distillation : Distillation is an important method used to separate. (i) Volatile liquids from non-volatile impurities (ii) Liquids having sufficient difference in their boiling point.

3.3.1 Simple distillation :

Liquids which boil without decomposition at atmospheric pressure are purified by the process of **simple distillation**. In this process the liquid is first converted into its vapour by boiling and then the vapour is condensed back into liquid by cooling, and the pure liquid trickles down in the receiver.

The apparatus used for simple distillation is shown in Fig. 3.4. It consists of round bottom flask fitted with a cork having a thermometer. The flask has a side arm through which it is connected to a condenser. The condenser has a jacket with two outlets through which water is circulated. The liquid to be distilled is taken in the round bottom flask fixed by clamp. The flask is placed in a water bath or oil bath or sometimes wire gauze is kept on a stand as shown in Fig 3.4.

The condenser is connected to receiver to collect the purified liquid. Care is taken that the bulb of the thermometer is just below the side arm of the round bottom flask.

The flask is heated. As the boiling point of the liquid is reached it starts boiling and the vapors rise to the neck of the flask and pass through the side arm into the cooler parts of the condenser, which is kept cool by circulating water through its jacket. The vapours condense and the liquid is collected in the receiver.

Activity : To separate the components of a liquid mixture containing acetone (b. p. 56°C) and water (b. p. 100°C)

Apparatus : Distillation flask with condenser, two receivers, thermometer, etc.

Chemicals : mixture of acetone and water.

Principle : Acetone and water are two miscible liquids having a wide difference in their boiling points. Acetone boils at 56°C while boiling point of water is 100°C . When the mixture of acetone and water is heated and temperature of the mixture reaches 56°C acetone would distil off. When all acetone distils out and when the temperature rises to 100°C water would to distil out.

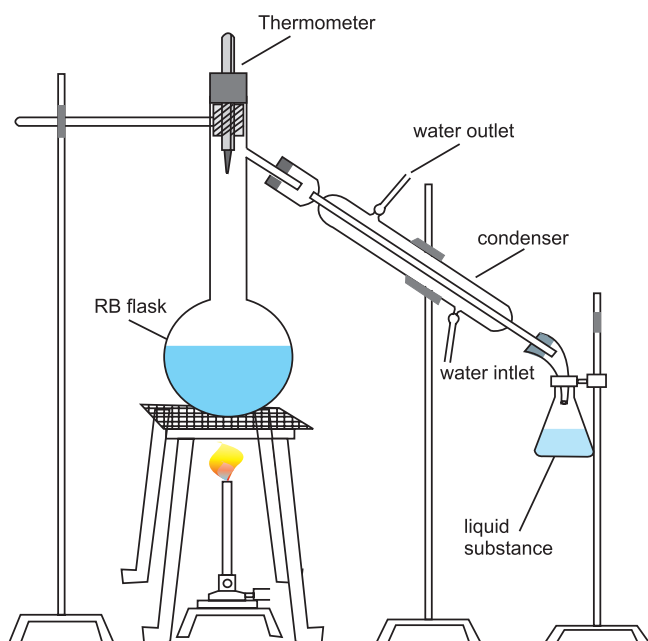

Fig. 3.4 : Simple distillation

Procedure : Take the mixture of water and acetone in the distillation flask and arrange the apparatus. Heat the flask on a water bath carefully. At 56 °C acetone will distil out, collect it in receiver number 1. After all acetone distilled, change the receiver. Discard a few ml of the liquid. As the temperature reaches 100 °C water will begin to distil. Collect this in receiver number 2.

3.3.2 Fractional Distillation :

If in a mixture the difference in boiling points of two liquids is not appreciable, they cannot be separated from each other using the simple distillation assembly.

To separate such liquids, the process called fractional distillation is employed in which a special assembly is used (see Fig. 2.5(a)). In this assembly the distillation flask is fitted with a fractionating column (Fig. 3.5 (b)). Hence, the vapours first pass through the fractionating column. Vapours of more volatile liquid with lower boiling point rise up more than the vapours of liquid having higher boiling point.

Suppose we have a mixture of two liquid (A) and (B) having boiling points 363 K and 373 K respectively. A is more volatile and B is less volatile. As the mixture is heated, vapors of (A) along with a little of (B) rise up and come in contact with the large surface of the fractionating column. Vapors of (B) condense rapidly into the distillation flask. While passing through the fractionating column there is an exchange between the ascending vapors and descending liquid. The vapors of B are scrubbed off by the descending liquid, this makes the vapors richer in (A). This process is repeated each time the vapors and liquid come in contact with the surface in the fractionating column. Rising vapors become richer in (A) and escape through the fractionating column and reach the condenser while the liquid in the distillation flask is richer in B. The separated components are further purified by repeating the process. Mixtures of acetone (b.p. 329 K) and methyl alcohol (b.p. 337.7 K); acetone and benzene (353 K) can be separated by fractional distillation.

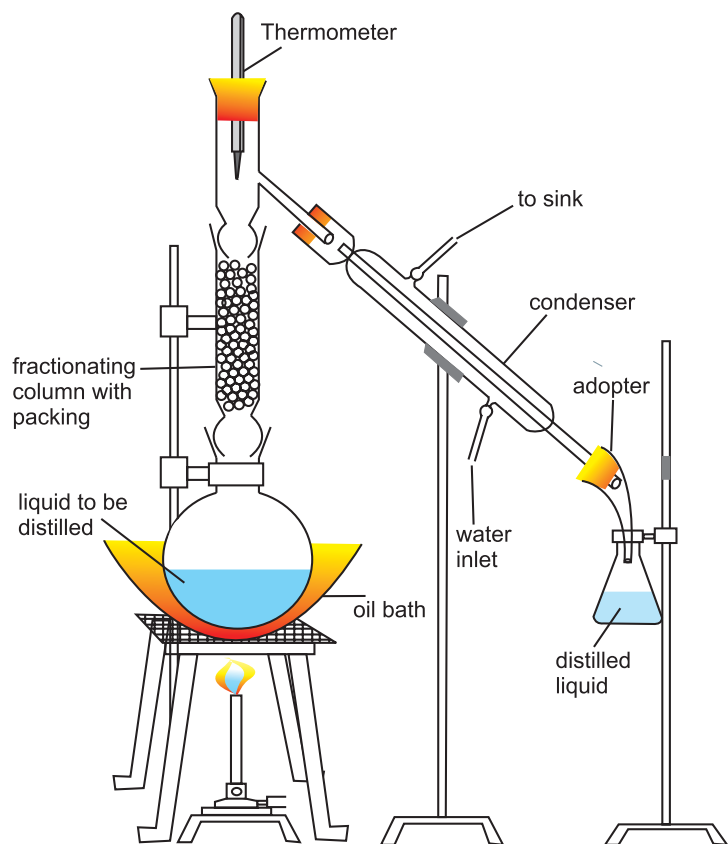

Fig. 3.5 (a) : Fractional distillation

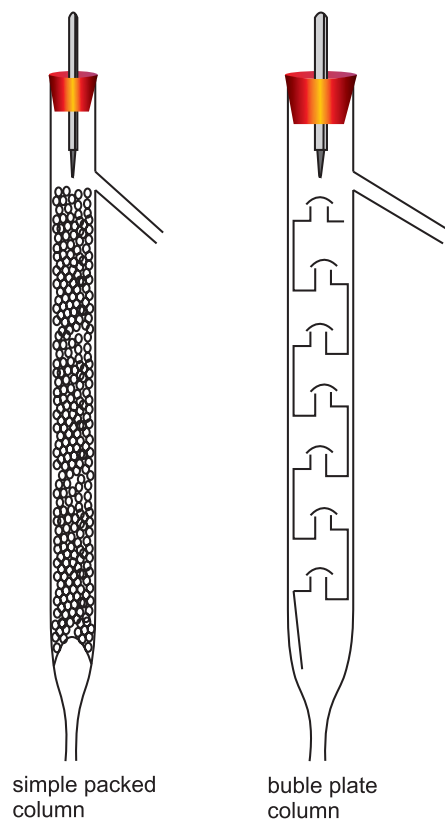

Fig 3.5 (b) : Fractionating Columns

This process is used in petroleum industry to separate different fractions of crude oil.

3.3.3 Distillation under Reduced Pressure :

Liquids having very high boiling point or those which decompose on heating are purified by carrying out distillation under reduced pressure. In this method the liquid is made to boil at a temperature which is below its normal boiling point by reducing the pressure on the surface of the liquid. Pressure is reduced using a water pump or vacuum pump. In soap industry glycerol is separated from soap by using this technique.

3.4 Solvent Extraction : When an organic substance is present in an aqueous solution, it can be extracted from that solution by shaking it with an organic solvent in which the substance is more soluble. The organic liquid should be immiscible with water and be able to form two layers. In this process the solute distributes itself between two immiscible liquids. From the aqueous phase the solute gets extracted in the organic phase. Extraction of compound takes place based on the difference in solubility of compound in two liquids (See Fig. 3.6). On shaking for a few times with small volumes of organic phase, most of the solute gets extracted into the organic phase. The organic solvent is, then, removed by distillation and the solute is collected.

The solvent extraction process is important as it helps clean separations in a short time span.

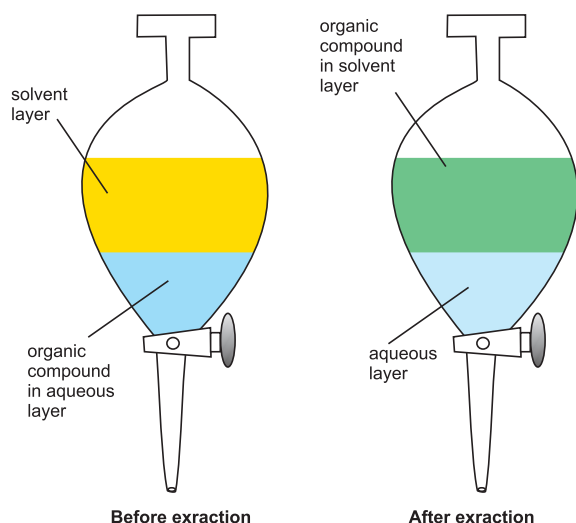

Fig. 3.6 : Solvent Extraction

If the solute is less soluble in organic phase then a technique called **continuous extraction** is used where the same amount of organic solvent is used repeatedly for extraction. This technique involves continuous distillation of the solvent within the same assembly. Thus use of large quantity of organic solvent is avoided.



Internet my friend

Get more information about continuous extraction/soxhlet extraction from YouTube.Royal Society of chemistry Soxhlet extraction.

3.5 Chromatographic techniques :

Chromatography is a technique used to separate components of a mixture, and also purify compounds. The name of the technique comes from the Greek word Chroma meaning Colour.

In 1903, Tswett discovered this technique for separating the coloured components found in plants. The principle of separation of substances in this technique is similar to solvent extraction i. e. distribution of the solutes in two phases. In chromatography we use two phases for separation. **(a)** Stationary phase and **(b)** Mobile phase. This technique is based on the difference in rates at which components in the mixture move through the stationary phase under the influence of the mobile phase. First the mixture of components is loaded at one end of the stationary phase and then the mobile phase, which is a pure solvent or a mixture of solvents, is allowed to move over the stationary phase. Depending on the relative affinity of the components toward the stationary phase and mobile phase they remain on the surface of the stationary phase or move along with the mobile phase, and gradually get separated.

The stationary phase can be a solid or a liquid. Depending on the stationary phase, chromatography is classified into Adsorption Chromatography and Partition Chromatography.

3.5.1 Adsorption Chromatography : This type of Chromatography is based on the principle of Differential Adsorption. Different solutes are adsorbed to different extent on the stationary phase. Adsorption Chromatography is of the following two types.

i. Column Chromatography : This type involves the separation of components over a column of stationary phase. The stationary phase material can be Alumina, Silica gel. A slurry of the stationary phase material is filled in a long glass tube provided with a stopcock at the bottom and a glass wool plug at the lower end. The mixture to be separated is dissolved in a small amount of appropriate solvent and is then loaded on top of the adsorbent column. A suitable mobile phase which could be a single solvent or a mixture of solvents is then poured over the adsorbent column. The mixture along with the mobile phase slowly moves down the column. The solutes get adsorbed on the stationary phase and depending on the degree to which they are adsorbed, the solutes get separated from each other. The most strongly adsorbed component is retained on the column and others move down the column to various distances forming bands as seen in Fig. 3.7. The component which is less strongly adsorbed is desorbed first and leaves the column first, while the strongly adsorbed component is eluted later.

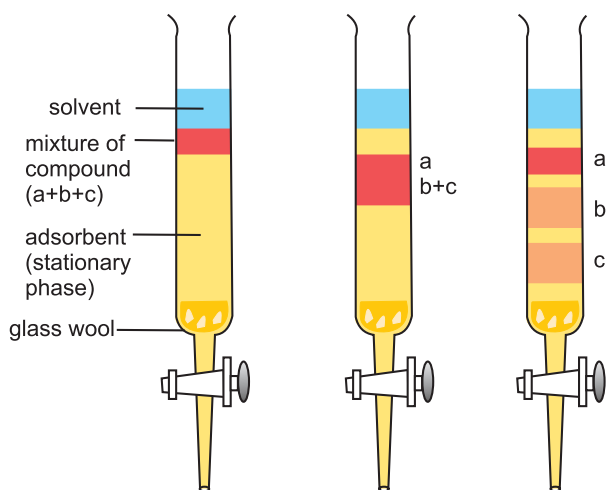

FIG 3.7 Column Chromatography. Different stages of separation.

The solutions of these components are collected separately. On evaporating the solvent the solutes can be recovered.

ii. Thin Layer Chromatography : A thin layer (0.2 mm thick) of adsorbent silica gel or alumina spread over a glass plate acts as the stationary phase. The plate is called the TLC plate or chromplate. The mixture of solutes is applied on the Chromplate as a small spot about 2 cm from one end of the plate as shown in Fig. 3.8.

The plate is then placed in a closed jar containing the mobile phase such that the spot is well above the mobile phase. As the mobile phase rises up the components of the mixture move along with it. They move up to different distances depending upon their degree of adsorption and thus get separated. If the components are colored they appear as separated colored spots on the plate. If the components are not colored but have property of fluorescence they can be visualised under UV light, or the plate can be kept in a chamber containing a few iodine crystals. The Iodine vapors are adsorbed by the components and

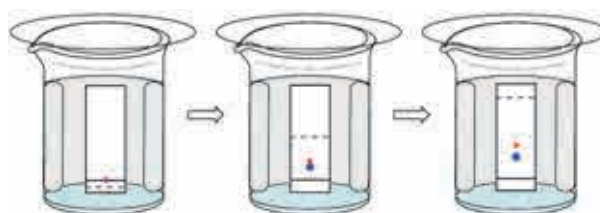

Fig. 3.8 (a) Stages in Thin Layer Chromatography

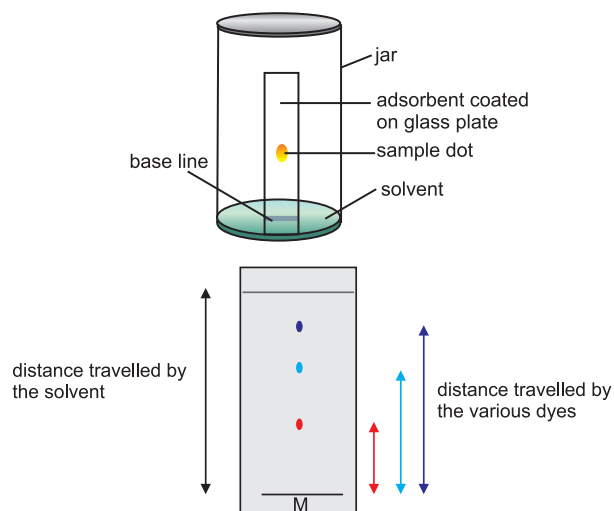

Fig. 3.8 (b) Developed chromatogram.

the spots appear brown. Amino acids are visualised by spraying the plate with a solution of ninhydrin. This is known as spraying agent.

3.5.2 Partition Chromatography : In this type of chromatography the stationary phase and mobile phase both are liquids. Separation of components takes place by continuous differential partitioning of the components between the stationary and mobile phases. For example, Paper Chromatography : In this technique a special quality paper, Whatmann paper number 1, is used. The water trapped in the fibres of the paper acts as the stationary phase. The solution of mixture is spotted on the strip of the Chromatography paper at the about 2 cm from one end of the paper using a glass capillary. The paper is then suspended in a chamber containing the mobile phase taking care that the spot does not dip in the mobile phase (Fig. 3.9).

The mobile phase rises up by capillary action and flows over the spot. Partitioning of the components takes place between stationary phase (water) and the mobile phase.

Different solutes are retained differently on the paper depending on their selective partitioning between the two phases. This developed paper strip is the chromatogram. Similar to TLC (Thin layer chromatography)

the colored components are visible as colored spots and the colourless components are observed under UV light or using a spraying agent.

Retention factor (R_f) : Migration of the solute relative to the solvent front gives an idea about the relative retention of the solutes on the stationary phase. This is termed as the R_f of the solute.

$$R_f = \frac{\text{Distance travelled by the solute from the base line}}{\text{Distance travelled by the solvent from the base line}}$$

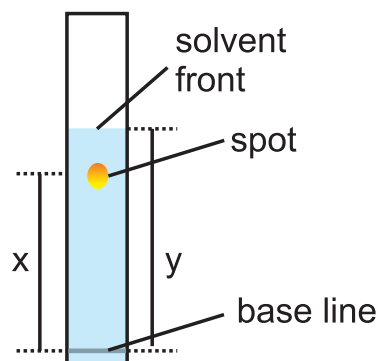

Fig. 3.10 : Retention factor



Internet my friend

Column chromatography
<https://youtube/KqQITxvFDLB8>

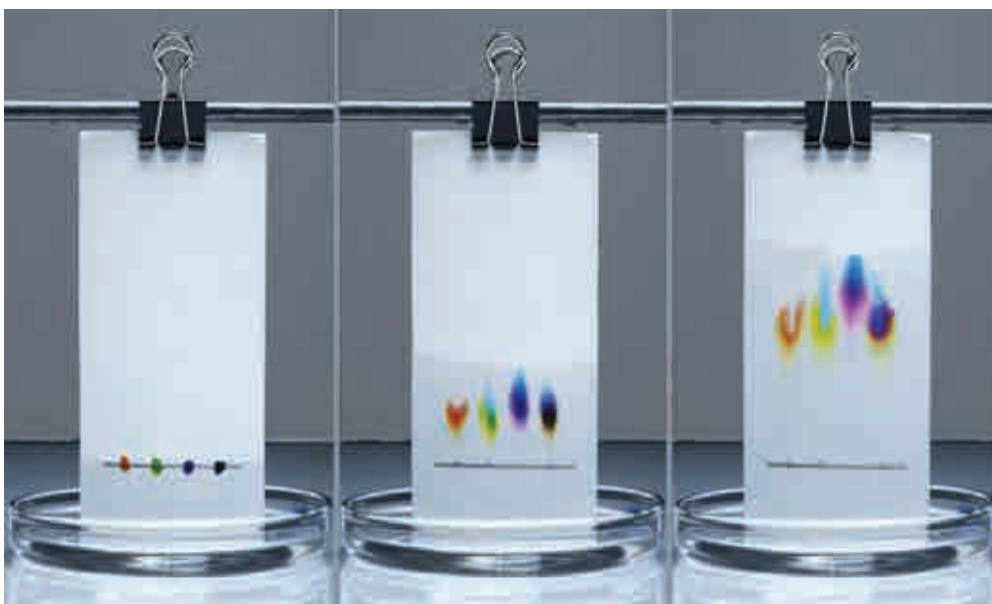

Fig. 3.9 : Stages in Paper chromatography



Exercises

1. Choose the correct option

- A. Which of the following methods can be used to separate two compounds with different solubilities in the same solvent?
- Fractional crystallization
 - Crystallization
 - Distillation
 - Solvent extraction
- B. Which of the following techniques is used for separation of glycerol from soap in soap industry ?
- Distillation under reduced pressure
 - Fractional distillation
 - Filtration
 - Crystallization
- C. Which technique is widely used in industry to separate components of mixture and also to purify them ?
- Steam distillation
 - Chromatography
 - Solvent extraction
 - Filtration
- D. A mixture of acetone and benzene can be separated by the following method :
- Simple distillation
 - Fractional distillation
 - Distillation under reduced pressure
 - Sublimation
- E. Colourless components on chromatogram can be observed by the following :
- Using UV light
 - Using iodine chamber
 - Using the spraying reagent
 - Using infrared light

2. Answer the following

- A. Which of the following techniques is used for purification of solid organic compounds?
- Crystallisation
 - Distillation
- B. What do you understand by the terms
- residue
 - filtrate.
- C. Why is a condenser used in distillation process?
- D. Why is paper moistened before filtration?
- E. What is the stationary phase in Paper Chromatography?

- F. What will happen if the upper outlet of the condenser is connected to the tap instead of the lower outlet?
- G. Give names of two materials used as stationary phase in chromatography.
- H. Which properties of solvents are useful for solvent extraction?
- I. Why should spotting of mixture be done above the level of mobile phase ?
- J. Define : a. Stationary phase b. Saturated solution
- K. What is the difference between simple distillation and fractional distillation?
- L. Define a. Solvent extraction b. Distillation.
- M. List the properties of solvents which make them suitable for crystallization.
- N. Name the different types of Chromatography and explain the principles underlying them.
- O. Why do we see bands separating in column chromatography?
- P. How do you visualize colourless compounds after separation in TLC and Paper Chromatography?
- Q. Compare TLC and Paper Chromatography techniques.

3. Label the diagram and explain the process in your words.



Activity :

Use any one analytical technique in laboratory and discuss it in groups.

4. Structure of Atom



Can you recall?

- What is the smallest unit of matter ?
- What is the difference between molecules of an element and those of a compound ?
- Does an atom have any internal structure or is it indivisible ?
- Which particle was identified by J. J. Thomson in the cathode ray tube experiment ?
- Which part of an atom was discovered by Ernest Rutherford from the experiment of scattering of α -particles by gold foil ?

4.1 Subatomic particles : Dalton's atomic theory was able to explain the laws of chemical combination successfully. However, it failed to explain some properties of matter. For example, it could not explain why substances like glass or ebonite when rubbed with silk or fur, generate electricity. Discovery of subatomic particles in late nineteenth and early twentieth century set a blow to Dalton's atomic model of hard sphere. Three important subatomic particles which are of concern to were found. Chemistry are proton, electron and neutron. Proton and neutron are present in the atomic nucleus and together are called nucleons. Electrons are present in the extranuclear part of an atom. The properties of electron, proton and neutron are summarised in Table 4.1

Table 4.1 : Properties of subatomic particles

Name	Symbol	Absolute charge/C	Relative charge	Symbol for charge	Mass/kg	Mass/u	Approximate mass/u
Electron	e	-1.6022×10^{-19}	-1	$-e$	9.10938×10^{-31}	0.00054	0u
Proton	p	$+1.6022 \times 10^{-19}$	+1	$+e$	1.6726×10^{-27}	1.00727	1u
Neutron	n	0	0		1.67493×10^{-27}	1.00867	1u

4.1.1 Discovery of electron : In the year 1897, **J. J. Thomson** investigated the cathode rays and found that the cathode rays are a stream of very small, negatively charged particles which are 1837 times lighter than a hydrogen atom and are present in all atoms. Later these particles were named as electrons.

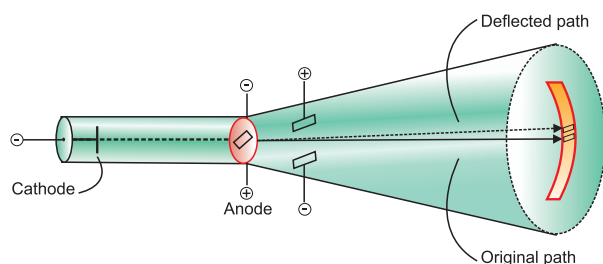

Fig. 4.1 : Cathode ray tube experiment

4.1.2 Discovery of proton : In the year 1911, **Ernest Rutherford** found in the experiment of scattering of α -particles by thin gold foil (see Fig. 4.2) that a few α -particles bounce back. From this he inferred the presence of massive and positively charged nucleus inside the atom. Following the discovery of nucleus in an atom, Rutherford found (1919) that fast moving α -particles transmuted nitrogen into oxygen with simultaneous liberation of hydrogen.



He further showed that other elements could also be transmuted, but hydrogen was always emitted.

On this basis Rutherford proposed that the hydrogen nucleus must be contained inside nuclei of all the elements. Hence, the hydrogen nucleus was renamed as **proton**.

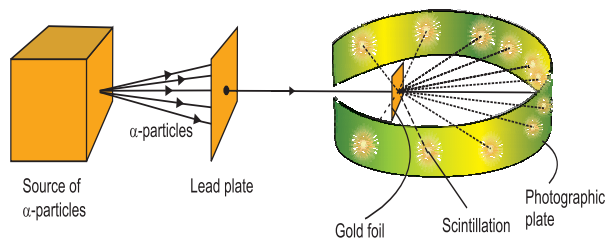

Fig. 4.2 : Rutherford's scattering experiment

4.1.3 Discovery of neutron : Existence of an electrically neutral and massive particle in the nucleus was predicted by Ernest Rutherford in 1920 to account for the disparity in atomic number and atomic mass of an element. In the year 1932, **James Chadwick** measured velocity of protons knocked out from paraffin by an unidentified radiation from beryllium. (See Fig. 4.3). From that he determined the mass of the particles of the unidentified neutral radiation which came out to be almost the same as that of a proton. He named this particle as '**neutron**' which was predicted by Rutherford earlier.

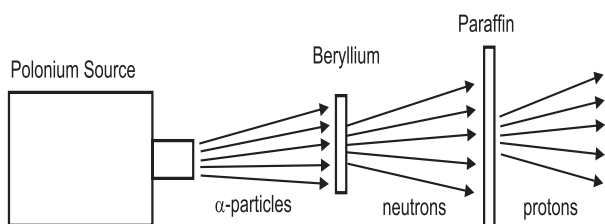

Fig. 4.3 : Discovery of neutron

4.2 Atomic number and atomic mass number

The number of protons in the nucleus is chemical identity of an element. This number is called as atomic number (Z) of the element. The positive charge on the nucleus is due to the protons present in it ($+Ze$). Atom being electrically neutral, it contains the same number of extranuclear electrons in it as its atomic number. Therefore the total electronic charge on an atom is $-Ze$. Thus in any atom,

$$\begin{aligned} \text{Atomic number } (Z) &= \text{Number of protons} \\ &= \text{Number of electrons} \end{aligned}$$

As can be seen from Table 4.1, mass of an electron is negligibly small compared to that of the nucleons. As a result the mass of an atom can be considered to be concentrated in its nucleus. The approximate mass of one proton or one neutron is 1u. Therefore approximate atomic mass in daltons is numerically equal to the number of nucleons in the atom. The number of neutrons in the nucleus is designated by the symbol N ; and the total number of protons and neutrons, that is nucleons, in an atom is called its atomic mass number (A).

$$\begin{aligned} \text{Mass number } (A) &= \text{Number of protons } (Z) \\ &+ \text{Number of Neutrons } (N) \end{aligned}$$

$$\text{Therefore } A = Z + N \quad N = A - Z$$

The composition of any atom is represented by element symbol (X) with the atomic mass number (A) as superscript on left and atomic number (Z) as subscript its :



The atom or nucleus having a unique composition as specified by ${}^A_Z X$ is called a **nuclide**.

Problem 4.1: Find out the number of protons, electrons and neutrons in the nuclide ${}^{40}_{18}\text{Ar}$

Solution : In case of the nuclide ${}^{40}_{18}\text{Ar}$,
 $A = 40$ and $Z = 18$
 Number of protons = number of electrons = $Z = 18$ and number of neutrons $N = A - Z$
 $= 40 - 18 = 22$

4.3 Isotopes, isobars and isotones

Similarities in composition of nuclides results in three types of relationships.

i. Isotopes : Some elements exist as single natural nuclide. For example ${}^{19}_9\text{F}$.

However, many elements exist naturally as mixture of two or more types of atoms or nuclides. These individual nuclides are called isotopes of that element.

All the isotopes of an element have the same number of protons but different number of neutrons in their nuclei. As the proton number is the atomic number, all the isotopes of an element have the same position in the modern periodic table which exhibit similar chemical properties. All the natural isotopes of an element coexist and a definite natural abundance. Table 4.2 shows various features of the three common isotopes of carbon.

ii. Isobars : The atoms of different elements having the same mass number but different atomic numbers are called isobars. Isobars are different elements. They have different chemical properties and occupy different positions in modern periodic table. Table 4.3 shows an illustration of isobars.

Problem 4.2 : The two natural isotopes of chlorine viz. ${}_{17}^{35}\text{Cl}$ and ${}_{17}^{37}\text{Cl}$ exist in relative abundance of 3:1. Find out the average atomic mass of chlorine.

Solution: From the relative abundance 3:1, it is understood that out of 4 chlorine atoms, 3 atoms have mass 35 and 1 has mass 37.

Therefore, the average atomic mass of chlorine

$$= \frac{3 \times 35 + 1 \times 37}{4} = 35.5$$

\therefore Atomic mass of chlorine = 35.5

Table 4.2 : Isotopes of carbon

Symbol	Atomic Number Z	Atomic mass Number A	Neutron Number $N = A - Z$	% Abundance	Stability
${}_{6}^{12}\text{C}$ or C-12	6	12	6	98.9 %	Stable
${}_{6}^{13}\text{C}$ or C-13	6	13	7	1.1 %	Stable
${}_{6}^{14}\text{C}$ or C-14	6	14	8	< 0.00017 %	Radioactive

Table 4.3 : Isobars

Isobars	Atomic No. Z	Mass No. A	Number of protons Z	No. of neutrons N
${}_{6}^{14}\text{C}$	6	14	6	8
${}_{7}^{14}\text{N}$	7	14	7	7

Problem 4.3 : Three elements Q, R and T have mass number 40. Their atoms contain 22, 21 and 20 neutrons, respectively. Represent their atomic composition with appropriate symbol.

Solution : $A = Z + N \quad \therefore Z = A - N$

For the given three elements $A = 40$. Values of their atomic numbers Z , are obtained from the given values of neutron numbers, N , using the above expression.

for Q : $Z = A - N = 40 - 22 = 18$

for R : $Z = A - N = 40 - 21 = 19$

for T : $Z = A - N = 40 - 20 = 20$

\therefore The atomic composition of the three elements is written as follows :

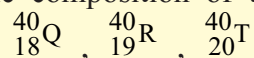

iii. **Isotones : The atoms of different elements having same number of neutrons in their nuclei are called isotones.** Table 4.4 shows examples of isotones.

Table 4.4 : Isotones

Isotones	Atomic number Z	Mass number A	Number of Neutrons $N = A - Z$
${}_{5}^{11}\text{B}$	5	11	6
${}_{6}^{12}\text{C}$	6	12	6

We will consider some more aspects of nuclides in the Chapter 13.

4.4 Drawbacks of Rutherford atomic model

i. Let us now go back to the point of time when Rutherford put forth his nuclear model of atom. It is akin to a miniature of the solar system, the nucleus playing the role of the massive sun and the electrons are lighter planets. Electrons in this model could not be stationary as the electrostatic force of attraction exerted would pull them towards itself, and this would form a miniature version of Thomson's atomic model. However, the electrons revolving about the nucleus, as described by Rutherford, also pose a problem. Electrons in the Rutherford model are negatively charged particles in orbital motion. Such orbital motion is an accelerated motion accompanied by a continuous change in the velocity of electron as noticed from the continuously changing direction. According to the electromagnetic theory of Maxwell, accelerated charged particles would emit electromagnetic radiation. An electron in an orbit would emit radiation, equivalent energy possessed by the radiation associated with the electronic motion. The orbit would, therefore, shrink continuously. **Thus, an electron orbiting about the nucleus would follow a spiral path to the nucleus.** It can be seen that the Rutherford atomic model has an intrinsic instability of atom. However, real atoms are stable.

ii. The second serious drawback of the Rutherford model is that it **does not describe the distribution of electrons** around the nucleus **and their energies**. The drawbacks of the Rutherford model were overcome in the Bohr atomic model.

4.5 Developments leading to the Bohr's atomic model :

At the time when different models of atomic structure were being put forth, some results obtained from the studies of **interactions of radiation with matter** required to be correlated to atomic structure. Niels Bohr utilized these results to get over the drawbacks of Rutherford atomic model. These results were : (1) wave particle duality of electromagnetic radiation and (2) line emission spectra of hydrogen.

4.5.1 Wave particle duality of electromagnetic radiation :

A dilemma was posed by electromagnetic radiation in the world of science. Phenomena such as **diffraction and interference of light** could be explained by treating light as electromagnetic wave. On the other hand, the **black-body radiation or photoelectric effect** could not be explained by wave nature of light, and only accounted for by considering particle nature of light. The only way to resolve the dilemma was to accept that light has dual behaviour. When light interacts with matter it behaves as a stream of **particles** called **photons**, when light propagates, it behaves as an **electromagnetic wave**.

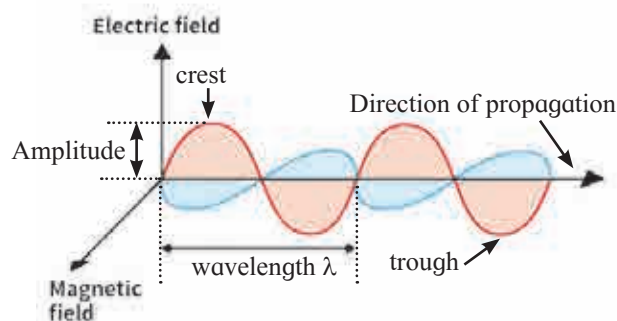

Fig 4.4 : Electromagnetic wave

a. Characteristics of electromagnetic wave

Figure 4.4 shows a schematic representation of an electromagnetic wave. Various parameters used to describe the different types of electromagnetic radiation are wavelength, frequency, wavenumber, amplitude, and velocity.

i. Wavelength (λ) : The distance between two consecutive crests or troughs is called wavelength. It is represented by the symbol λ which is a greek letter (lambda). The SI unit for wavelength is metre (**m**).

ii. Frequency (ν) : The number of waves that pass a given point in one second is called frequency. It is represented by the greek letter nu, (ν). The SI unit of frequency is Hertz (H_2 or s^{-1}).

iii. Wavenumber ($\bar{\nu}$) : Wavenumber is the number of wavelengths per unit length. Wavenumber is represented by the symbol (nu bar) ($\bar{\nu}$). The commonly used unit for wavenumber is reciprocal centimeter (cm^{-1}), while the SI unit is m^{-1} . Wavenumber is related to the wavelength by an expression $\bar{\nu} = \frac{1}{\lambda}$

iv. Amplitude (A): Amplitude of a wave is the height of the crest. Square of the amplitude denotes the intensity of the radiation.

Problem 4.4 : Visible light has wavelengths ranging from 400 nm (violet) to 750 nm (red). Express these wavelengths in terms of frequency (Hz).

(1 nm = 10^{-9} m)

Solution : $c = \nu\lambda \quad \therefore \nu = \frac{c}{\lambda}$

\therefore frequency of violet light =

$$\frac{3 \times 10^8 \text{ m s}^{-1}}{400 \times 10^{-9} \text{ m}} = 7.50 \times 10^{14} \text{ Hz}$$

and frequency of red light =

$$\frac{3 \times 10^8 \text{ m s}^{-1}}{750 \times 10^{-9} \text{ m}} = 4.00 \times 10^{14} \text{ Hz}$$

Different regions of electromagnetic radiation have different values of frequency or wavelengths. Thus the radiofrequency region is around 10^6 Hz, microwave region is around 10^{10} Hz, infrared region is around 10^{13} Hz, ultraviolet region is around 10^{16} Hz.

In vacuum, the speed of all the types of electromagnetic radiation is the same, which is $3.0 \times 10^8 \text{ m s}^{-1}$ ($2.997925 \times 10^8 \text{ m s}^{-1}$ to be precise). This is called speed of light, and is denoted by the symbol ' c '.

The parameters wavelength (λ), frequency (ν) and the speed of light (c) are related by the expression : $c = \nu \lambda$

b. Particle nature of electromagnetic radiation : In the year 1900, Max Plank put forth his quantum theory to explain black-body radiation. According to this theory, the energy of electromagnetic radiation depends upon the frequency and not the amplitude. Plank gave the name '**quantum**' to the smallest quantity of energy that can be emitted or absorbed in the form of electromagnetic radiation. The energy (E) of one quantum of radiation is proportional to its frequency (ν) and given by

$$E = h\nu \quad \text{..... (4.1)}$$

The proportionality constant ' h ' is called **Plank's Constant**. Later its value was found out to be $6.626 \times 10^{-34} \text{ J s}$.

In the year 1905, Albert Einstein explained the photoelectric effect using Plank's quantum theory. In doing so he considered **electromagnetic radiation as a stream of photons of energy $h\nu$** . A photon has zero rest mass.

4.5.2 Line emission spectrum of hydrogen :

When a substance is irradiated with light it absorbs energy. Atoms, molecules or ions, which have absorbed radiation are said to be '**excited**'. Heating can also result in an excited state. When an excited species gives away the absorbed energy in the form of radiation, the process is called emission of radiation. The recorded spectrum of this emitted radiation is called '**emission spectrum**'.

Problem 4.5 : Parameters of blue and red light are 400 nm and 750 nm respectively. Which of the two is of higher energy ?

Solution : 400 nm and 750 nm are the wave lengths of blue and red light, respectively. Energy of radiation is given by the expression $E = h\nu$ and ν , the frequency, of radiation is related to the wavelength by the expression.

$$\nu = \frac{c}{\lambda}$$

Therefore, shorter the wavelength, λ , larger the frequency, ν , and higher the energy, E . Thus, blue light which has shorter λ (400nm) than red light (750nm) has higher energy.

Of all the elements, hydrogen has the simplest emission spectrum.

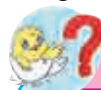

Do you know ?

Fluorescent tube, sodium vapor lamp, neon sign, halogen lamp are all examples of atomic emission.

When electric discharge is passed through gaseous hydrogen, it emits radiation. Hydrogen emission spectrum was studied by five scientists in late nineteenth century. They recorded the hydrogen emission spectra in different regions of electromagnetic radiation. The spectra were not continuous and comprised of a series of lines corresponding to different frequencies (see Fig. 4.5)

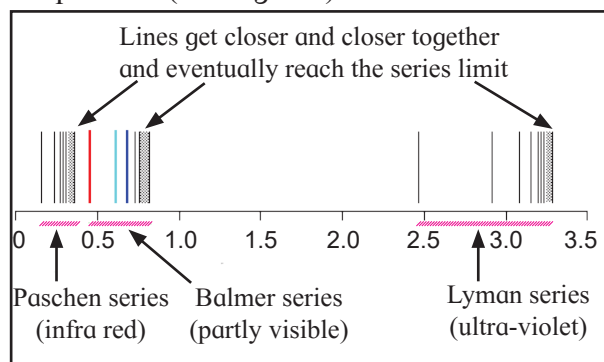

Fig. 4.5 : Emission line spectrum of hydrogen

In the year 1885 Balmer expressed the wavenumbers of the emission lines in the visible region of electromagnetic radiation by the formula

$$\bar{\nu} = 109677 \left[\frac{1}{2^2} - \frac{1}{n^2} \right] \text{ cm}^{-1}, \quad \dots (4.2)$$

where $n = 3, 4, 5, \dots$

The lines described by this formula are called Balmer series. J. Rydberg found that all the five series of lines could be described by the following general expression.

$$\bar{\nu} = 109677 \left[\frac{1}{n_1^2} - \frac{1}{n_2^2} \right] \text{ cm}^{-1}, \quad \dots (4.3)$$

where $n_1 = 1, 2, 3, \dots$

$n_2 = [n_1+1], [n_1+2], [n_1+3], \dots$

The value $109,677 \text{ cm}^{-1}$ is called Rydberg constant for hydrogen ' R_H '. Table 4.5 shows the distinctive features of these five series.

Table 4.5 : Series of emission spectral lines for hydrogen

Series	n_1	n_2	Spectral region
Lyman	1	2,3,.....	Ultraviolet
Balmer	2	3,4,.....	Visible
Paschen	3	4,5,.....	Infrared
Brackett	4	5,6,.....	Infrared
Pfund	5	6,7,.....	Infrared

4.6 Bohr's model for hydrogen atom : Niels Bohr (1913) put forth his postulates about the atomic model for hydrogen. While doing so he used the quantum theory, wave particle duality of electromagnetic radiation and the emission line spectra of hydrogen.

4.6.1 Postulates of Bohr atomic theory

Bohr's model of hydrogen atom is based on the following postulates.

1. The electron in the hydrogen atom can move around the nucleus in one of the many possible circular paths of fixed radius and energy. These paths are called orbits, stationary states or allowed energy states. These orbits are arranged concentrically around the nucleus in an increasing order of energy.

2. The energy of an electron in the orbit does not change with time. However, the electron will move from a lower stationary state to a higher stationary state if and when the required amount of energy is absorbed by the electron. Energy is emitted when electron moves from a higher stationary state to a lower one. The energy change does not take place in a continuous manner.

Angular Momentum :

Angular momentum is a product of moment of inertia (I) and angular velocity (ω) omega

Angular momentum = $I \times \omega$; but

$I = m r^2$ and $\omega = v/r$

\therefore Angular momentum = $m r^2 \times v/r = mvr$

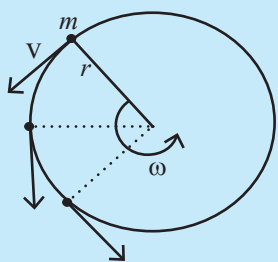

3. The frequency of radiation absorbed or emitted when transition occurs between two stationary states that differ in energy by ΔE is given by the following expression

$$\nu = \frac{\Delta E}{h} = \frac{E_2 - E_1}{h} \dots\dots (4.4)$$

Where E_1 and E_2 are the energies of the lower and higher allowed energy states respectively. This expression is commonly known as **Bohr's frequency rule**.

4. The angular momentum of an electron in a given stationary state can be expressed as

$$mvr = n \times \frac{h}{2\pi} \text{ where } n = 1, 2, 3 \dots\dots (4.5)$$

Thus, an electron can move only in those orbits for which its angular momentum is integral multiple of $h/2\pi$. Thus only certain fixed orbits are allowed here.

4.6.2 Results of Bohr's theory : Bohr's theory is used to derive the energies of orbits, that is, the stationary states, in hydrogen atom. The results of Bohr's theory for hydrogen atom are summarized here.

a. The stationary states for electron are numbered $n = 1, 2, 3, \dots\dots$. These integers are known as **principal quantum numbers**.

b. The radii of the stationary states are

$$r_n = n^2 a_0,$$

where $a_0 = 52.9$ pm (picometer). Thus, the radius of the first stationary state, called the Bohr radius is 52.9 pm.

c. The most important property associated with the electron is the energy of its stationary state. It is given by the expression.

$$E_n = -R_H (1/n^2), \text{ where } n = 1, 2, 3, \dots\dots (4.6)$$

R_H is the Rydberg constant for hydrogen and its value in joules is 2.18×10^{-18} J

The lowest energy state is called the **ground state**. Energy of the ground $1/1^2$ state is

$$E_1 = -2.18 \times 10^{-18} / 1^2 = -2.18 \times 10^{-18} \text{ J}$$

Energy of the stationary state corresponding to $n = 2$ is

$$E_2 = -2.18 \times 10^{-18} (1/(2)^2) = -0.545 \times 10^{-18} \text{ J}$$



Just think

What does the negative sign of electron energy convey ?

A free electron at rest is an electron that is at infinity from the nucleus and does not experience any electrostatic force of attraction towards the nucleus and therefore, it is assigned the energy value of zero.

The negative sign means that the energy of the electron in the atom is lower than the energy of a free electron at rest. Mathematically this corresponds to setting 'n' equal to infinity in the equation so that $E_\infty = 0$. As the electron gets close to the nucleus, 'n' decreases E_n becomes large in absolute value and more and more negative. Thus stationary states with smaller values of 'n' have large and negative energy. The negative sign corresponds to attractive force between the electron and nucleus.



Do you know ?

The Bohr's theory is applicable to hydrogen atom and hydrogen-like species which contain only one extranuclear electron.

Problem 4.6 :

How many electrons are present in ${}^2_1\text{H}$, ${}^2_2\text{He}$ and He^\oplus ? Which of these are hydrogen like species?

Solution : Hydrogen-like species contain only one electron.

${}^2_1\text{H}$ number of protons = 1

= number of electrons

${}^2_2\text{He}$: number of protons = 2

= number of electrons

He^\oplus : (number of electron in He)-1

= (number of electron in He^\oplus)

= (2 - 1) = 1

Thus ${}^2_1\text{H}$ and He^\oplus are hydrogen-like species.

d. Bohr theory can be applied to hydrogen like species. For example He^\oplus , $\text{Li}^{2\oplus}$, $\text{Be}^{3\oplus}$ and so on. Energies of the stationary states associated with these species are given by :

$$E_n = -2.18 \times 10^{-18} \left(\frac{Z^2}{n^2} \right) \text{ J} \quad \text{..... (4.7)}$$

and radii by the expression

$$r_n = \frac{52.9(n^2)}{Z} \text{ pm}, \quad \text{..... (4.8)}$$

where Z is the atomic number. From the above expression it can be seen that the energy decreases (becomes more negative) and radius becomes smaller as the value of Z increases.

e. Velocities of electrons can also be calculated from the Bohr theory. Qualitatively it is found that the magnitude of velocity of an electron increases with increase of Z and decreases with increase in the principal quantum number n .

Problem 4.7 :

Calculate the radius and energy associated with the first orbit of He^\oplus .

Solution : He^\oplus is a hydrogen-like species having the nuclear charge $Z = 2$ and for the first orbit $n = 1$ radius of first orbit of He^\oplus

$$r_1 = \frac{52.9(n^2)}{Z} = \frac{52.9 \times 1^2}{2}$$

Energy of first orbit of He^\oplus

$$\begin{aligned} E_n &= -2.18 \times 10^{-18} \left(\frac{Z^2}{n^2} \right) \text{ J} \\ &= -2.18 \times 10^{-18} \left(\frac{2^2}{1^2} \right) \\ &= -8.72 \times 10^{-18} \text{ J} \end{aligned}$$

4.6.3 Explanation of the line spectrum of hydrogen using Bohr theory :

The line emission spectrum (Fig. 4.5) obtained from atomic hydrogen can be explained quantitatively using Bohr theory. According to second postulate of Bohr theory, radiation is emitted when electron moves from an outer orbit of higher principal quantum number (n_i) to an inner orbit of lower principal quantum number (n_f). The energy difference (ΔE) between the initial and final orbit of the electronic transition corresponds to the energy of the emitted radiation. From the third postulate of Bohr theory ΔE can be expressed as

$$\Delta E = E_i - E_f \quad \text{..... (4.9)}$$

According to the results derived from Bohr theory the energy E of an orbit is related to its principal quantum number ' n ' by the Eq. (4.6).

$$E = -R_H \left(\frac{1}{n^2} \right) \quad \text{..... (4.6)}$$

Combining these two Eq. (4.9) and Eq. (4.6) we get:

$$\Delta E = \left[-\frac{R_H}{n_i^2} \right] - \left[-\frac{R_H}{n_f^2} \right] = R_H \left[\frac{1}{n_f^2} - \frac{1}{n_i^2} \right]$$

Substituting the value of R_H in joules we get

$$\Delta E = 2.18 \times 10^{-18} \left[\frac{1}{n_f^2} - \frac{1}{n_i^2} \right] \text{ J} \quad \text{.....(4.10)}$$

This expression can be rewritten in terms of wavenumber of the emitted radiation in the following steps.

We know: $(\Delta E) \text{ J} = (h) \text{ J s} \times (\nu) \text{ Hz} \dots (4.1)$

and by definition

$$(\bar{\nu}) \text{ cm}^{-1} = \frac{(\nu) \text{ Hz}}{(c) \text{ cm s}^{-1}} \quad \text{.....(4.11)}$$

combining these Eq. (4.10), Eq. (4.1) and Eq. (4.11) we get

$$\begin{aligned} \therefore (\bar{\nu}) \text{ cm}^{-1} &= \frac{(\Delta E)}{(h) \text{ J s}} \times \frac{1}{(c) \text{ cm s}^{-1}} \\ &= \frac{2.18 \times 10^{-18}}{6.626 \times 10^{-34} \times 3 \times 10^{10}} \left[\frac{1}{n_f^2} - \frac{1}{n_i^2} \right] \text{ cm}^{-1} \\ \therefore (\bar{\nu}) \text{ cm}^{-1} &= 109677 \left[\frac{1}{n_f^2} - \frac{1}{n_i^2} \right] \text{ cm}^{-1} \end{aligned}$$

This appears like the Rydberg Eq. (4.3), where $n_f = n_1$ and $n_i = n_2$.

In other words, Bohr theory successfully accounts for the empirical Rydberg equation for the line emission spectrum of hydrogen. In the Rydberg equation 'n₁' and 'n_f' are integers. Bohr's theory assigns physical meaning to them as principal quantum numbers corresponding to the concentric orbits. The integers in Rydberg equation, stand for the final orbit, n_f of electronic transition and n₁ for the initial orbit.

The emission lines comprising the five series thus, are result of electronic transitions from the excited hydrogen atoms.

The Lyman series is the result of moving of electron excited to higher orbits of n₂ = n_i = 2, 3, 4,.....etc. to lower orbits of n₁ = n_f = 1; the Balmer series results from electron from n₂ = n_i = 3, 4,..... to the lower orbit of n₁ = n_f = 2, so on and so forth. The electronic transitions giving rise to different emission line series of atomic hydrogen are shown in Fig. 4.6

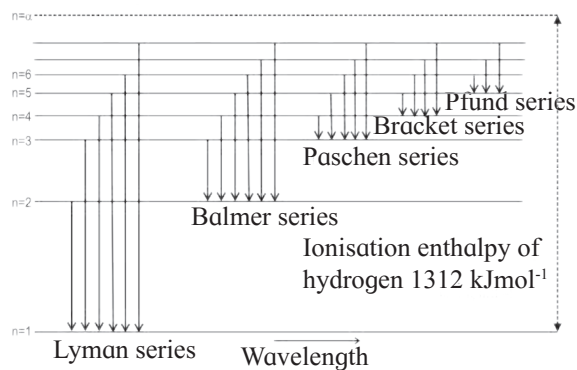

Fig. 4.6 : Electronic transition in the hydrogen spectrum

Problem 4.8 :

What is the wavelength of the photon emitted during the transition from the orbit of n = 5 to that of n = 2 in hydrogen atom?

Solution: The wavenumber of transition is given by Rydberg expression

$$(\bar{\nu}) = 109677 \left[\frac{1}{n_1^2} - \frac{1}{n_2^2} \right] \text{ cm}^{-1}$$

Here n₁ = 2 and n₂ = 5

$$\therefore (\bar{\nu}) = 109677 \left[\frac{1}{2^2} - \frac{1}{5^2} \right]$$

$$= 109677 \left[\frac{1}{4} - \frac{1}{25} \right]$$

$$= 109677 \times \frac{21}{100} = 23032.17 \text{ cm}^{-1}$$

$$\lambda = \frac{1}{23032.17}$$

$$\lambda = \frac{1}{\bar{\nu}} = 4.34 \times 10^{-5} \text{ cm}$$

wavelength of photon

$$\lambda = 4.34 \times 10^{-5} \text{ cm}$$

$$= 4.34 \times 10^{-5} \times 10^7 \text{ nm} = 434 \text{ nm}$$

4.6.4 Limitations of Bohr model

1. Bohr's atomic model failed to account for finer details of the hydrogen atom spectrum observed in sophisticated spectroscopic experiments.
2. Bohr model was unable to explain the spectrum of atoms other than hydrogen.
3. Bohr theory could not explain the splitting of spectral lines in the presence of a magnetic field (Zeeman effect) or electric field (Stark effect).

4. Bohr theory failed to explain the ability of atoms to form molecules by chemical bonds.

It was, therefore, thought that a better theory was needed to explain salient features of atomic structure.

4.6.5 Reasons for failure of the Bohr model

With the limitations of Bohr model for hydrogen atom becoming transparent, attempts were made to develop a better and general model for atom. This was possible because of two important developments took place after the Bohr model was postulated.

These development were :

1. de Broglie's proposal of dual behaviour of matter, and
2. Heisenberg uncertainty principle.

In Bohr model an electron is regarded as a charged particle moving in well defined circular orbits about the nucleus. In contrast to this **de Broglie** proposed in **1924** that matter should exhibit **a dual behaviour**, that is, both particle and wave like properties. This means that electron should have momentum, p , a property of particle as well as wavelength, λ , a property of wave. He gave the following relation between λ and p of a material particle.

$$\lambda = \frac{h}{mv} = \frac{h}{p}$$

De Broglie's prediction was confirmed by diffraction experiments (a wave property).



Internet my friend

Collect information about Structure of Atom.

In the year **1927 Werner Heisenberg** stated the uncertainty principle : **“It is impossible to determine simultaneously, the exact position and exact momentum (or velocity) of an electron.** In other words the position and momentum of an electron can not be determined with the same certainty. If the certainty of determination of one property of the two is high, it means that the uncertainty

of its determination is low. In that case the uncertainty of determination of the other property is very high.

Mathematically Heisenberg uncertainty principle is expressed as:

$$\Delta x \times \Delta p_x \geq \frac{h}{4\pi}$$

$$\Delta x \times \Delta(mv_x) \geq \frac{h}{4\pi}$$

$$\Delta x \times \Delta v_x \geq \frac{h}{4\pi}$$

Here Δx is the uncertainty in position and Δp_x (or Δv_x) is the uncertainty in momentum. A further implication of the uncertainty principle is that for an electron having certain energy one can only determine its probability at a particular point x around the nucleus. Bohr's model describes concentric orbits as well defined paths of the electron rotating about the nucleus and calculate energy of electron occupying these orbits. Bohr model assumes that both position and momentum, of the electron in hydrogen atom are known exactly at the same time, which is ruled out by the Heisenberg uncertainty principle. No attempt was made to extend the Bohr model to other atoms. A different approach to atomic model which could account for particle duality of matter and consistent with Heisenberg uncertainty principle was required. This became possible with the development of quantum mechanics.

4.7 Quantum mechanical model of atom :

A new branch of science, called **quantum mechanics**, was developed in **1926** by **Werner Heisenberg** and **Erwin Schrodinger** based on uncertainty principle and wave motion, respectively. Quantum mechanics based on the ideas of wave motion will be discussed here. Schrodinger developed the fundamental equation of quantum mechanics which incorporates wave particle duality of matter. The **Schrodinger equation** or **wave equation** is written as

$$\hat{H}\psi = E\psi \quad \text{..... (4.12)}$$

Here \hat{H} is a mathematical operator called Hamiltonian, Ψ (psi) is the wave function and E the total energy of the system. Solving Schrodinger equation is beyond the scope of this book. It may, however, be noted that solution of Schrodinger equation gives E and Ψ .

4.7.1 Schrodinger equation : When Schrodinger equation is solved for hydrogen atom, the possible values of energy (E) that the electron may have along with the corresponding wave function (ψ) are obtained. As a natural consequence of solving this equation, a set of **three quantum numbers** characteristic of the quantized energy levels and the corresponding wave functions are obtained. These are : **Principal quantum number (n), azimuthal quantum number (l) and magnetic quantum number (m_l).**

The solution of Schrodinger wave equation led to three quantum numbers and successfully predicted features of hydrogen atom emission spectrum. Splitting of spectral lines in multi-electron atomic emission spectra could not be explained through such model. These were explained by **George Uhlenbeck** and **Samuel Goudsmit (1925)** who proposed the presence of the **fourth quantum number** called **electron spin quantum number, m_s** .

Wave function, ψ , as such does not have any physical meaning. The probability of finding an electron at a point within an atom is proportional to Ψ^2 in the neighbourhood of that point (within a tiny volume element) around it.

4.7.2 Atomic orbitals and quantum numbers

Many wave function are possible for an electron, and therefore, many atomic orbitals in an atom. Thus the wave functions or atomic orbitals form the basis of the quantum mechanical electronic structure of an atom. Various orbitals in an atom differ in size, shape and orientation with respect to the nucleus depending upon the value of Ψ^2 . Each orbital is designated by three quantum numbers labelled as n , l and m_l , and each electron being assigned with four quantum numbers, viz, n , l , m_l and m_s .

The **principal quantum number ‘ n ’** is a positive integer with values of n being 1, 2, 3, 4, It identifies the shell. Atomic orbitals, having the same value ‘ n ’ belong to the same shell. With increase of ‘ n ’, the number of allowed orbitals in that shell increases and given by ‘ n^2 ’. A set of orbitals with given value of ‘ n ’ constitutes a single shell. Shells are represented by symbols K, L, M, N,..... so on. Table 4.6 shows ‘ n ’ and electronic shell symbol.

Table 4.6 : Allowed orbitals in the first four shells

Principal quantum number n	Shell symbol	Allowed number of orbitals n^2	Size of shell
1	K	1	↓ increases
2	L	4	
3	M	9	
4	N	16	

With an increase of ‘ n ’, the distance from the nucleus and size of the shell increases and also the energy increases (becoming lesser and lesser negative). In hydrogen-like species the energy of orbital depends only on the value of ‘ n ’. In the case of multi-electron atoms the energy of orbital depends on two quantum numbers ‘ n ’ and ‘ l ’ as well.

The **azimuthal quantum number, l** , is also called **subsidiary quantum number**. Atomic orbitals with the same value of ‘ n ’ but different values of ‘ l ’ constitute a subshell belonging to the shell for the given ‘ n ’. The number of subshells in a shell is equal to ‘ n ’. Thus, the third shell contains three subshells (with three different values of ‘ l ’), the second shell contains two subshells and the first shell contains only one subshell. The values of ‘ l ’ range from 0 to ($n - 1$). Thus, the K shell (with $n = 1$) contains only one subshell having $l = 0$. The subshells or sub-levels have ‘ l ’ to be 0, 1, 2, 3, which are represented by the symbols s, p, d, f,....., respectively.

The magnetic orbital quantum number, m_l , gives information about the relative spatial orientation of the orbitals in a given subshell.

For any subshell (defined by 'l' value) $(2l + 1)$ values of m_l are possible which range through :

$$m_l = -l, -(l-1), -(l-2), \dots, 0, \dots, (l-2), (l-1), l.$$

Thus for the subshell 's' with $l = 0$, the only allowed value of $m_l = 0$. In other words, 's' subshell has only one orbital in it. For the subshell 'p' having $l = 1$, the allowed values of m_l are -1, 0, +1. Thus 'p' subshell contain three orbitals having distinct orientations, and so on.

The sum of orbitals in a constituent subshell gives the total number of orbitals in a concerned shell and is given by n^2 . See Table 4.7

Electron spin quantum number, m_s , specifies the spin state of the electron in an orbital. An electron spins around its axis. This imparts spin angular momentum, to the electron.

The two orientations which the spin angular momentum of an electron can take up give rise to the spin states which can be distinguished from each other by the spin quantum number, m_s , which can be either $+1/2$ or $-1/2$. The two spin states are represented by two arrows, \uparrow (pointing up) and \downarrow (pointing down) and thus have opposite spins. **“An orbital can accommodate maximum two electrons and they must have opposite spins.”**

This is known as **Pauli exclusion principle** which will be dealt with in section 4.7.5

4.7.3 Shapes of atomic orbitals : The probability of finding an electron at a given point in an atom is proportional to square of the wave function ψ^2 at that point. According to Max Born ψ^2 at a point in an atom is the probability density of electron at that point.

Figure 4.7 (a) shows the probability density diagrams of 1s and 2s atomic orbitals. These diagrams appear like a cloud. The electron cloud of 2s orbital shows one node, which is a region with nearly zero probability density and displays the change of sign for its corresponding wavefunction.

Table 4.7 : Distribution of orbitals in shells and subshells

Shell	Principal quantum number n	Total orbitals in the shell n^2	Total number of subshells in a shell n	Azimuthal quantum number l	Number of orbitals in the subshell $2l+1$	Sum of orbitals in all the subshells
K	$n = 1$	$1^2 = 1$	1	$l = 0$	$2 \times 0 + 1 = 1$	1
L	$n = 2$	$2^2 = 4$	2	$l = 0$ $l = 1$	$2 \times 0 + 1 = 1$ $2 \times 1 + 1 = 3$	$1 + 3 = 4$
M	$n = 3$	$3^2 = 9$	3	$l = 0$ $l = 1$ $l = 2$	$2 \times 0 + 1 = 1$ $2 \times 1 + 1 = 3$ $2 \times 2 + 1 = 5$	$1 + 3 + 5 = 9$

(a) Probability density plots

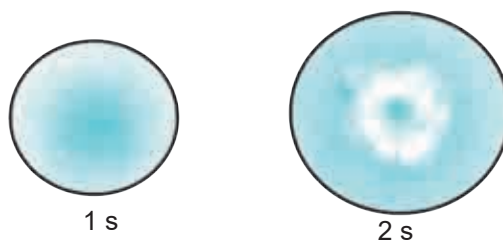

Fig. 4.7 : (a) Shapes of 1s and 2s orbitals

The Table 4.8 shows orbitals in the first four shells with the three quantum numbers for each orbital.

Table 4.8 : Orbital distribution in the first four shells

Symbol of Shell	Value of Principal quantum number (n)	Number of subshells	Value of Azimuthal Quantum number l	Symbol of subshell	Total Number of orbitals in the subshell = $2l + 1$	Values of the magnetic quantum number m_l for the subshell
K	$n = 1$	1	$l = 0$	1s	$2 \times 0 + 1 = 1$	$m_l = 0$
L	$n = 2$	2	$l = 0$	2s	$2 \times 0 + 1 = 1$	$m_l = 0$
			$l = 1$	2p	$2 \times 1 + 1 = 3$	$m_l = -1$ $m_l = 0$ $m_l = +1$
M	$n = 3$	3	$l = 0$	3s	$2 \times 0 + 1 = 1$	$m_l = 0$
			$l = 1$	3p	$2 \times 1 + 1 = 3$	$m_l = -1$ $m_l = 0$ $m_l = +1$
			$l = 2$	3d	$2 \times 2 + 1 = 5$	$m_l = -2$ $m_l = -1$ $m_l = 0$ $m_l = +1$ $m_l = +2$
N	$n = 4$	4	$l = 0$	4s	$2 \times 0 + 1 = 1$	$m_l = 0$
			$l = 1$	4p	$2 \times 1 + 1 = 3$	$m_l = -1$ $m_l = 0$ $m_l = +1$
			$l = 2$	4d	$2 \times 2 + 1 = 5$	$m_l = -2$ $m_l = -1$ $m_l = 0$ $m_l = +1$ $m_l = +2$
			$l = 3$	4f	$2 \times 3 + 1 = 7$	$m_l = -3$ $m_l = -2$ $m_l = -1$ $m_l = 0$ $m_l = +1$ $m_l = +2$ $m_l = +3$

Problem 4.9 How many orbitals make the N shell? What is the subshell wise distribution of orbitals in the N shell?

Solution: For N shell principal quantum number $n = 4$ \therefore Total number of orbitals in N shell = $n^2 = 4^2 = 16$ The total number of subshells in N shell = $n = 4$. The four subshells with their azimuthal quantum numbers and the constituent orbital number are as shown below

Azimuthal quantum number l	Symbol of subshell	number of orbitals $2l + 1$
$l = 0$	s	$(2 \times 0) + 1 = 1$
$l = 1$	p	$(2 \times 1) + 1 = 3$
$l = 2$	d	$(2 \times 2) + 1 = 5$
$l = 3$	f	$(2 \times 3) + 1 = 7$

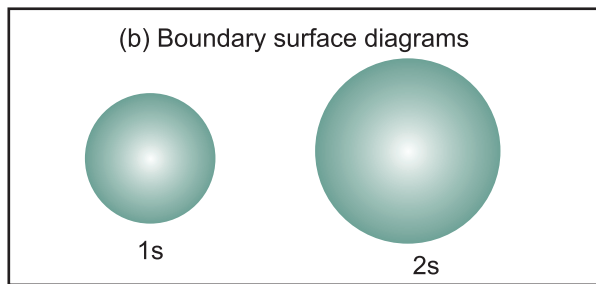

Fig 4.7 (b) : Shapes of 1s and 2s orbitals

Figure 4.7 (b) shows the boundary surface diagram of atomic orbitals 1s and 2s, which are spherical in shape. Here, a boundary surface is drawn in space for an orbital such that the value of probability density ψ^2 is constant and encloses a region where the probability of finding electron is typically more than 90%. Such a boundary surface diagram is a good representation of shape of an orbital.

Problem 4.10 : An atom has two electrons in its 4s orbital. Write the values of the four quantum numbers for each of them.

Solution: For the 4s orbital 4 stands for the principal quantum number n ; s stands for the subshell s having the value of azimuthal quantum number $l = 0$. In the 's' subshell there is only one orbital and has magnetic quantum number $m_l = 0$. The two electrons in this orbital have opposite spins. Thus the four quantum numbers of two electrons in 4s orbital are :

	n	l	m_l	m_s
electron 1	4	0	0	+ 1/2
electron 2	4	0	0	- 1/2



Do you know ?

The value of ψ^2 at any finite distance from the nucleus is never zero. Therefore a boundary surface enclosing 100% probability density (which occurs only at the infinity) cannot be drawn.

The s orbitals are spherical in shape. Their size increases with increase of n . It means that the electron is located farther away from the nucleus as the principal quantum number n increases.

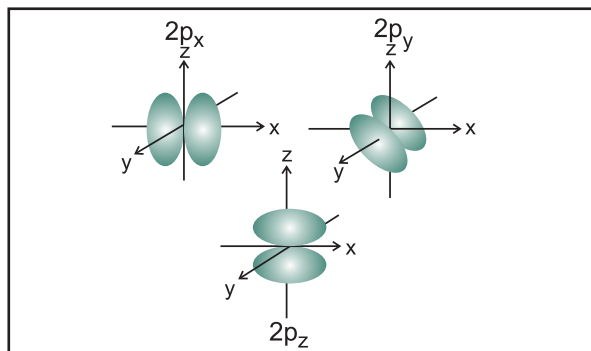

Fig. 4.8 : Shapes of 2p orbitals

Figure 4.8 displays the boundary surface diagram with the nucleus being at the origin, for the three 2p orbitals ($n = 2$ and $l = 1$). It can be seen that each p orbital has two lobes on the two sides of a nodal plane passing through the nucleus. (A nodal plane has ψ^2 very close to zero)

The size and energy of the dumbbell shaped three 2p orbitals are the same. Their orientations in space are, however, different. The lobes of the three 2p orbitals are along the x, y and z axes. Accordingly the corresponding orbitals are designated as $2p_x$, $2p_y$ and $2p_z$. The size and energy of the orbitals in p subshell increase with the increase of principal quantum number.

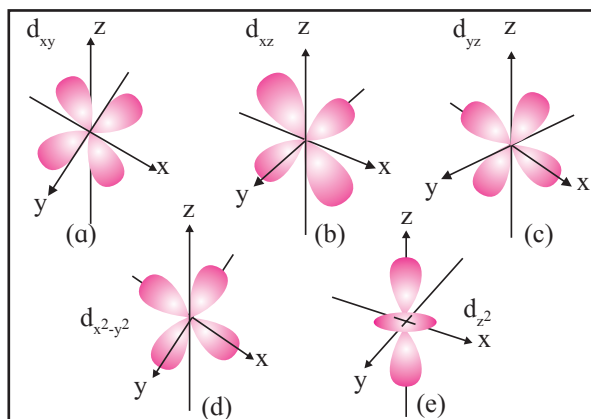

Fig. 4.9 : Shapes of 3d orbitals

There are five orbitals associated with d subshell. Designated by d_{xy} , d_{yz} , d_{xz} , $d_{x^2-y^2}$ and d_{z^2} . The shapes of the five 3d orbitals are shown in Figure 4.9. In spite of difference in their shapes, the five d orbitals are equivalent in energy. The shapes of 4d, 5d, 6d..... orbitals are similar to those of 3d orbitals, but their respective size and energies are large or they are said to be more diffused.

4.7.4 Energies of orbitals : The energy of an electron in the hydrogen atom or hydrogen-like species is determined by the principal quantum number alone. This is because the only interaction in these species is attraction between the electron and nucleus. An increasing order of energies of orbitals in the hydrogen atom is given by

$$1s < 2s = 2p < 3s = 3p = 3d < 4s = 4p = 4d = 4f < \dots\dots\dots$$

Of course the shapes of the concerned s, p, d, f orbitals are different, as described earlier. The orbitals with the same energy and the corresponding wave functions being different are called **degenerate orbitals**.

Thus, in hydrogen atom 2s and 2p are degenerate orbitals. In multi-electron atoms there is mutual repulsion among the electrons. The energy of an electron in a multi-electron atom, therefore, depends both on the principal quantum number, n , and the azimuthal quantum number, l . The lower the sum ($n + l$) for an orbital, the lower is its energy. If two orbitals have the same ($n + l$) values then orbital with the lower value of n is of lower energy. This is called the **($n + l$) rule**.

From the ($n + l$) rule the increasing order of energy of orbitals in multi-electron atoms can be written as: $1s < 2s < 2p < 3s < 3p < 4s < 3d < 4p < 5s < 4d < 5p < 6s < 4f < 5d < 6p < 7s \dots\dots\dots$ (See Table 4.9)

In a multi-electron atom, electrons occupy different orbitals. The lowest total electronic energy corresponds to the most stable, that is, the **ground state of an atom**. The orbital wise distribution of electrons in the ground state can be understood from what is called the **aufbau principle**.

4.7.5 Aufbau principle : ‘Aufbau’ is a German word meaning ‘building up’. The building up of orbital means filling up of orbitals with electrons in the ground state of an atom. The aufbau principle is based on, (i) Increasing order of energies of orbitals, (ii) Pauli’s exclusion principle, and (iii) Hund’s rule of maximum multiplicity.

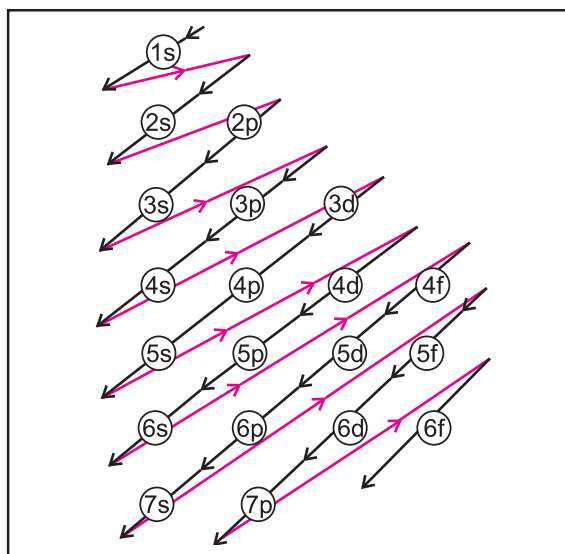

Fig. 4.10 : Increasing order of orbital energy

Table 4.9 : Dependence of orbital energy on ($n + l$) value

Orbital Energy	Principal quantum number n	Azimuthal quantum number l	$(n + l)$
1s	$n = 1$	$l = 0$	$1 + 0 = 1$
2s	$n = 2$	$l = 0$	$2 + 0 = 2$
2p	$n = 2$	$l = 1$	$2 + 1 = 3$
3s	$n = 3$	$l = 0$	$3 + 0 = 3$
3p	$n = 3$	$l = 1$	$3 + 1 = 4$
4s	$n = 4$	$l = 0$	$4 + 0 = 4$
3d	$n = 3$	$l = 2$	$3 + 2 = 5$
4p	$n = 4$	$l = 1$	$4 + 1 = 5$

↑ increases ↓

} $n = 2$ (lower)
} $n = 3$ (higher)
} $n = 3$ (lower)
} $n = 4$ (higher)
} $n = 3$ (lower)
} $n = 4$ (higher)

i. The increasing order of energies of orbitals

As seen in section 4.7.4, the increasing order of energies of orbitals is decided by the $(n + l)$ value. Electrons in the ground state atom are filled in the orbitals in an increasing order of energy. Fig 4.10 shows a useful method to remember this increasing order of orbital energy.

ii. Pauli exclusion principle : The capacity of an orbital to accommodate electrons is decided by Pauli exclusion principle. **Wolfgang Pauli (1926)** recognized that **“No two electrons in an atom can have the same set of four quantum numbers.”** Another way to state this Pauli exclusion principle is: **“Only two electrons can occupy the same orbital and they must have opposite spins.”** Pauli exclusion principle implies that for an electron belonging to the same orbital, the spin quantum number ' m_s ' must be different since the other three quantum numbers n , l and m_l are the same. There are only two values that ' m_s ' can which are $+1/2$ and $-1/2$. An orbital thus can accommodate only two electrons with opposite spins, so that the fourth quantum number is different for two occupying electrons. These two electrons with opposite spins occupying the same orbital are called an **electron pair**.

This principle is illustrated with helium atom He ($Z = 2$). Its electronic configuration is $1s^2$ as $\uparrow\downarrow$. And two electrons are in $1s$ orbital. The two non-identical combinations of the four quantum numbers of both electrons in helium are given in Table 4.10.

Table 4.10

Electron	Quantum number				Set of values of four quantum numbers
	n	l	m_l	m_s	
1 st electron	1	0	0	$+1/2$	(1, 0, 0, $+1/2$)
2 nd electron	1	0	0	$-1/2$	(1, 0, 0, $-1/2$)

It implies that two electrons in the same atom have always different set of quantum numbers that means, the set of (n, l, m_l) is the same and the m_s is different.

Since an orbital can accommodate up to two electrons only, the capacity of a shell with the principal quantum number n , to accommodate electrons is given by $2n^2$.

iii. Hund's rule of maximum multiplicity : Filling of electrons in the orbitals belonging to the same subshell (orbitals of equal energy or degenerate orbitals) follows the Hund's rule of maximum multiplicity. As per this rule **“Pairing of electrons in the orbitals belonging to the same subshell does not occur unless each orbital belonging to that subshell has got one electron each.”**

Consider, for example, filling of p subshell. The p subshell has three degenerate orbitals. Here pairing of electrons starts when the fourth electron enters the p subshell. The electronic configuration of four electrons occupying p-orbital then will be $\uparrow\downarrow\uparrow\uparrow$ and not as $\uparrow\downarrow\uparrow\downarrow$. It is observed that **half-filled and fully filled set of degenerate orbitals has extra stability.**

4.7.6 Electronic configuration of atoms and its representation :

Electronic configuration of an atom is the distribution of its electrons in orbitals. The electronic configuration can be written by applying the aufbau principle. There are two methods of representing electronic configuration:

(i) Orbital notation: $ns^a np^b nd^c \dots\dots\dots$

(ii) Orbital diagram: $\square \square \square \square \square \square \square$

In the **orbital notation method**, a shells is represented by the principal quantum number followed by respective symbol of a subshell and number of electrons occupying that subshell being written as super script on right side of the symbol. In the **orbital diagram method** each orbital in a subshell is represented by a box and the electron represented by an arrow (\uparrow for up spin and \downarrow for low spin) placed in the respective boxes. In this second method all the four quantum numbers of electron are accounted for. Electronic configuration of a few elements is illustrated in Table 4.11.

Table 4.11 : Representation of electronic configuration

Element symbol	Orbital notation	Orbital diagram
${}_1\text{H}$	$1s^1$	$\begin{array}{ c } \hline \uparrow \\ \hline 1s \end{array}$
${}_2\text{He}$	$1s^2$	$\begin{array}{ c } \hline \uparrow\downarrow \\ \hline 1s \end{array}$
${}_3\text{Li}$	$1s^2 2s^1$	$\begin{array}{ c } \hline \uparrow\downarrow \\ \hline 1s \end{array} \quad \begin{array}{ c } \hline \uparrow \\ \hline 2s \end{array}$
${}_4\text{Be}$	$1s^2 2s^2$	$\begin{array}{ c } \hline \uparrow\downarrow \\ \hline 1s \end{array} \quad \begin{array}{ c } \hline \uparrow\downarrow \\ \hline 2s \end{array}$
${}_9\text{F}$	$1s^2 2s^2 2p^5$	$\begin{array}{ c } \hline \uparrow\downarrow \\ \hline 1s \end{array} \quad \begin{array}{ c } \hline \uparrow\downarrow \\ \hline 2s \end{array} \quad \begin{array}{ c c c } \hline \uparrow\downarrow & \uparrow\downarrow & \uparrow \\ \hline 2p \end{array}$

Condensed orbital notation of electronic configuration : The orbital notation of electronic configuration of an element with high atomic number comprises a long train of symbols of orbitals with an increasing order of energy. It can be condensed by dividing it into two parts. Electronic configuration of the preceding inert gas is a part of the electronic configuration of any element. In the condensed orbital notation it is implied by writing symbol of that inert gas in a square bracket. It is core part of the electronic configuration of that element. The outer configuration is specific to a particular element and written immediately after the bracket. For example, the orbital notation of potassium 'K (Z = 19) is, $1s^2 2s^2 2p^6 3s^2 3p^6 4s^1$ ' Its core part is the electronic configuration of the preceding inert gas argon 'Ar : $1s^2 2s^2 2p^6 3s^2 3p^6$ ', while ' $4s^1$ ' is an outer part. Therefore the condensed orbital notation of electronic configuration of potassium is 'K : [Ar] $4s^1$.' Table 4.12 displays detailed and condensed orbital notations of electronic configuration of various elements with atomic numbers from 1 to 30.



Internet my friend

Visit following link, download the information and make a presentation.
www.thoughtco.com/definition.

Electronic configurations of Cu and Cr

Chromium : Atomic number of chromium is 24. Expected electronic configuration is $1s^2 2s^2 2p^6 3s^2 3p^6 4s^2 3d^4$; In that case 3d is not half-filled. Hence, it has less stability.

Interelectronic repulsion makes one 4s electron enter into one of empty 3d orbitals, thereby both 4s and 3d orbitals become half-filled so that chromium atom acquires extra stability. Its electronic configuration is $1s^2 2s^2 2p^6 3s^2 3p^6 4s^1 3d^5$.

Copper : Atomic number of copper is 29. The expected electronic configuration is $1s^2 2s^2 2p^6 3s^2 3p^6 4s^2 3d^9$. Here 3d orbital is neither half-filled nor fully filled. Due to interelectronic repulsions forces one 4s electron to enter into 3d which makes it completely filled with 4s being half-filled. Hence copper atom acquires extra stability. Now electronic configuration of Cu is $1s^2 2s^2 2p^6 3s^2 3p^6 4s^1 3d^{10}$.

Isoelectronic species : Atoms and ions having the **same number of electrons** are **isoelectronic**. The electronic configuration of the isoelectronic species is the same. Consider K^{\oplus} formed by removal of one electron from K atom.

Which has 19 electrons (Z = 19). Therefore K^{\oplus} has 18 electrons

Number of electrons	K (Z = 19)	\rightarrow	$\text{K}^{\oplus} + e^{\ominus}$
	19		18

Species such as Ar, $\text{Ca}^{2\oplus}$ containing 18 electrons are isoelectronic with K^{\oplus} .

Electronic configuration of all these species with 18 electrons is $1s^2 2s^2 2p^6 3s^2 3p^6$.

Table 4.12 Electronic configuration of the first thirty elements

Atomic Number	Element	K ($n = 1$)	L ($n = 2$)	M ($n = 3$)	N ($n = 4$)	Condensed notation of electronic configuration
1	Hydrogen	$1s^1$				$1s^1$
2	Helium	$1s^2$				$1s^2$
3	Lithium	$1s^2$	$2s^1$			[He] $2s^1$
4	Beryllium	$1s^2$	$2s^2$			[He] $2s^2$
5	Boron	$1s^2$	$2s^2 2p^1$			[He] $2s^2 2p^1$
6	Carbon	$1s^2$	$2s^2 2p^2$			[He] $2s^2 2p^2$
7	Nitrogen	$1s^2$	$2s^2 2p^3$			[He] $2s^2 2p^3$
8	Oxygen	$1s^2$	$2s^2 2p^4$			[He] $2s^2 2p^4$
9	Fluorine	$1s^2$	$2s^2 2p^5$			[He] $2s^2 2p^5$
10	Neon	$1s^2$	$2s^2 2p^6$			[He] $2s^2 2p^6$
11	Sodium	$1s^2$	$2s^2 2p^6$	$3s^1$		[Ne] $3s^1$
12	Magnesium	$1s^2$	$2s^2 2p^6$	$3s^2$		[Ne] $3s^2$
13	Aluminium	$1s^2$	$2s^2 2p^6$	$3s^2 3p^1$		[Ne] $3s^2 3p^1$
14	Silicon	$1s^2$	$2s^2 2p^6$	$3s^2 3p^2$		[Ne] $3s^2 3p^2$
15	Phosphorous	$1s^2$	$2s^2 2p^6$	$3s^2 3p^3$		[Ne] $3s^2 3p^3$
16	Sulfur	$1s^2$	$2s^2 2p^6$	$3s^2 3p^4$		[Ne] $3s^2 3p^4$
17	Chlorine	$1s^2$	$2s^2 2p^6$	$3s^2 3p^5$		[Ne] $3s^2 3p^5$
18	Argon	$1s^2$	$2s^2 2p^6$	$3s^2 3p^6$		[Ne] $3s^2 3p^6$
19	Potassium	$1s^2$	$2s^2 2p^6$	$3s^2 3p^6$	$4s^1$	[Ar] $4s^1$
20	Calcium	$1s^2$	$2s^2 2p^6$	$3s^2 3p^6$	$4s^2$	[Ar] $4s^2$
21	Scandium	$1s^2$	$2s^2 2p^6$	$3s^2 3p^6 3d^1$	$4s^2$	[Ar] $4s^2 3d^1$
22	Titanium	$1s^2$	$2s^2 2p^6$	$3s^2 3p^6 3d^2$	$4s^2$	[Ar] $4s^2 3d^2$
23	Vanadium	$1s^2$	$2s^2 2p^6$	$3s^2 3p^6 3d^3$	$4s^2$	[Ar] $4s^2 3d^3$
24	Chromium	$1s^2$	$2s^2 2p^6$	$3s^2 3p^6 3d^5$	$4s^1$	[Ar] $4s^2 3d^5$
25	Manganese	$1s^2$	$2s^2 2p^6$	$3s^2 3p^6 3d^5$	$4s^2$	[Ar] $4s^2 3d^5$
26	Iron	$1s^2$	$2s^2 2p^6$	$3s^2 3p^6 3d^6$	$4s^2$	[Ar] $4s^2 3d^6$
27	Cobalt	$1s^2$	$2s^2 2p^6$	$3s^2 3p^6 3d^7$	$4s^2$	[Ar] $4s^2 3d^7$
28	Nickel	$1s^2$	$2s^2 2p^6$	$3s^2 3p^6 3d^8$	$4s^2$	[Ar] $4s^2 3d^8$
29	Copper	$1s^2$	$2s^2 2p^6$	$3s^2 3p^6 3d^{10}$	$4s^1$	[Ar] $4s^1 3d^{10}$
30	Zinc	$1s^2$	$2s^2 2p^6$	$3s^2 3p^6 3d^{10}$	$4s^2$	[Ar] $4s^2 3d^{10}$

Problem 4.11 : Write electronic configuration of ${}_{18}\text{Ar}$ and ${}_{19}\text{K}$ using orbital notation and orbital diagram method.

Solution : From the atomic numbers it is understood that 18 electron are to be filled in Ar atom and 19 electrons are to be filled in K atom. These are to be filled in the orbitals according to the aufbau principle. The electronic configuration of these atoms can be represented as.

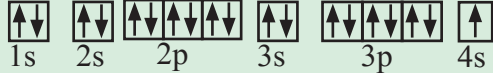
	Orbital notation	Orbital diagram
${}_{18}\text{Ar}$	$1s^2 2s^2 2p^6 3s^2 3p^6$	
${}_{19}\text{K}$	$1s^2 2s^2 2p^6 3s^2 3p^6 4s^1$	

Problem 4.12

Find out one dinegative anion and one unipositive cation which are isoelectronic with Ne atom. Write their electronic configuration using orbital notations and orbital diagram method.

Solution:

Ne has $Z = 10$. Therefore Ne and its isoelectronic species contain 10 electrons each. The dinegative anionic species isoelectronic with Ne is obtained by adding two electrons to the atom with $Z = 8$. This is $\text{O}^{2\ominus}$. The unipositive cationic species isoelectronic with Ne is obtained by removing one electron from an atom of $Z = 11$. It is Na^{\oplus} . These species and their electronic configuration are shown below :

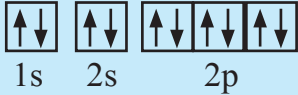
	Number of electron	Orbital Notation	Orbital diagram
Ne	10	$1s^2 2s^2 2p^6$	
$\text{O} + 2e^{\ominus} \rightarrow \text{O}^{2\ominus}$	10		
$\text{Na} - e^{\ominus} \rightarrow \text{Na}^{\oplus}$	10		



Exercises

1. Choose correct option.

- A. The energy difference between the shells goes on when moved away from the nucleus.
- Increasing
 - decreasing
 - equalizing
 - static
- B. The value of Plank's constant is -
- $6.626 \times 10^{-34}\text{Js}$
 - $6.023 \times 10^{-24}\text{Js}$
 - $1.667 \times 10^{-28}\text{Js}$
 - $6.626 \times 10^{-28}\text{Js}$
- C. p-orbitals are..... in shape.
- spherical
 - dumb bell
 - double dumbell
 - diagonal
- D. "No two electrons in the same atoms can have identical set of four quantum numbers". This statement is known as -
- Pauli's exclusion principle
 - Hund's rule

c. Aufbau rule

d. Heisenberg uncertainty principle

E. Principal Quantum number describes-

a. shape of orbital

b. size of the orbital

c. spin of electron

d. orientation of in the orbital electron cloud

2. Make the pairs:

'A'

'B'

a. Neutrons

i. six electrons

b. p-orbital

ii. $-1.6 \times 10^{-19}\text{C}$

c. charge on electron

iii. Ultraviolet region

d. Lyman series

iv. Chadwick

3. Complete the following information about the isotopes in the chart given below :

Substance	Mass Number	Number of		
		Protons	Neutrons	Electrons
Carbon-14				
Lead-208				
Chlorine-35				
Uranium-238				
Oxygen-18				
Radium-223				

(Hint: Refer to Periodic Table if required)

4. Match the following :

Element	No. of Neutron
a. ${}^{40}_{18}\text{Ar}$	i. 7
b. ${}^{14}_6\text{C}$	ii. 21
c. ${}^{40}_{19}\text{K}$	iii. 8
d. ${}^{14}_7\text{N}$	iv. 22

5. Answer in one sentence :

- If an element 'X' has mass number 11 and it has 6 neutrons, then write its representation.
- Name the element that shows simplest emission spectrum.
- State Heisenberg uncertainty principle.
- Give the names of quantum numbers.
- Identify from the following the isoelectronic species:
Ne, O^{2-} , Na^+ OR Ar, Cl^{2-} , K^{\oplus}

6. Answer the following questions.

- Differentiate between Isotopes and Isobars.
- Define the terms:
 - Isotones
 - Isoelectronic species
 - Electronic configuration
- State and explain Pauli's exclusion principle.
- State Hund's rule of maximum multiplicity with suitable example.
- Write the drawbacks of Rutherford's model of an atom.
- Write postulates of Bohr's Theory of hydrogen atom.
- Mention demerits of Bohr's Atomic model.
- State the order of filling atomic orbitals following Aufbau principle.

- Explain the anomalous behavior of copper and chromium.
- Write orbital notations for electrons in orbitals with the following quantum numbrs.
 - $n = 2, l = 1$
 - $n = 4, l = 2$
 - $n = 3, l = 2$
- Write electronic configurations of Fe, Fe^{2+} , Fe^{3+}
- Write condensed orbital notation of electronic configuration of the following elements:
 - Lithium ($Z=3$)
 - Carbon ($Z=6$)
 - Oxygen ($Z=8$)
 - Silicon ($Z=14$)
 - Chlorine ($Z=17$)
 - Calcium ($Z=20$)
- Draw shapes of 2s and 2p orbitals.
- Explain in brief, the significance of azimuthal quantum number.
- If $n=3$, what are the quantum number l and m ?
- The electronic configuration of oxygen is written as $1s^2 2s^2 2p_x^2 2p_y^1 2p_z^1$ and not as $1s^2 2s^2 2p_x^2, 2p_y^2 2p_z^0$, Explain.
- Write note on 'Principal Quantum number.
- Using concept of quantum numbers, calculate the maximum numbers of electrons present in the 'M' shell. Give their distribution in shells, subshells and orbitals.
- Indicate the number of unpaired electrons in :
 - Si ($Z=14$)
 - Cr ($Z=24$)
- An atom of an element contains 29 electrons and 35 neutrons. Deduce-
 - the number of protons
 - the electronic configuration of that element



Activity :

Collect information about discoveries of sub atomic particles and present in class by using power point presentation.

5. Chemical Bonding

5.1 Introduction : Why are atoms held together in chemical compounds? There must be some force that holds them together. You have already learnt in lower classes that the forces holding atoms together in a compound are the chemical bonds.

How are chemical bonds formed between two atoms? There are two ways of formation of chemical bonds (i) by loss and gain of electrons (ii) by sharing a pair of electrons between the two atoms. In either process of formation of chemical bond each atom attains a stable noble gas electronic configuration.

Which electrons are involved in the formation of chemical bonds? The electrons present in the outermost shell of an atom are involved in the formation of a chemical bond.

5.2 Kossel and Lewis approach to chemical bonding : Number of attempts were made to explain the formation of chemical bond in terms of electrons, but the first satisfactory explanation was given by W.Kossel and G.N. Lewis independently. They gave a logical explanation of valence which was based on the inertness of noble gases. On the basis of this they proposed a theory of valence known as Electronic theory of valence in 1916.

According to Lewis, the atom can be pictured in terms of a positively charged 'kernel' (the nucleus plus inner electrons) and outer shell that can accommodate a maximum of eight electrons. This octet of electrons represents a stable electronic arrangement.

Lewis stated that each atom achieves stable octet during the formation of a chemical bond. In case of sodium and chlorine this can be achieved by transfer of one electron from sodium to chlorine. Thus Na^{\oplus} (2, 8) and Cl^{\ominus} (2, 8, 8) ions are formed which held together. In case of other molecules like H_2 , F_2 , Cl_2 , HCl etc. the bond is formed by the sharing of a pair of electrons between the atoms. In this process each atom attains a stable outer octet of electrons.

Octet rule : In 1916 Kossel and Lewis proposed an important theory for explaining the formation of chemical bond known as Electronic Theory of Valence. This theory is mainly based on octet rule developed by Lewis. Octet rule is based on stability of noble gases due to presence of eight electrons (ns^2np^6) in the valence shell.

This rule states that during the formation of chemical bond, atom loses, gains or shares electrons so that its outermost orbit (valence shell) contains eight electrons. Therefore the atom attains the nearest inert gas electronic configuration.

The octet rule is found to be very useful in explaining the normal valence of elements and in the study of the chemical combination of atoms leading to the formation of molecule. However it should be noted that octet rule is not valid for H and Li atoms. These atoms tend to have only two electrons in their valence shell similar to that of Helium ($1s^2$) which called duplet.

5.2.1 Ionic bond

I. Formation of sodium chloride (NaCl)

The electronic configurations of Sodium and Chlorine are :

Na ($Z = 11$) $1s^2 2s^2 2p^6 3s^1$ or 2, 8, 1

Cl ($Z = 17$) $1s^2 2s^2 2p^6 3s^2 3p^5$ or 2, 8, 7



Internet my friend

Search more atoms which complete their octet during chemical combinations.

Sodium has one electron in its valence shell. It has a tendency to lose one electron to acquire the configuration of the nearest noble gas Ne (2, 8). Chlorine has seven electrons in its valence shell. It has a tendency to gain one electron and thereby acquire the configuration of the nearest noble gas Ar (2, 8, 8). During the combination of sodium and chlorine atoms, the sodium atom transfers its valence electron

to the chlorine atom, sodium atom changes into Na^{\oplus} ion while the chlorine atom changes into Cl^{\ominus} ion. The two ions are held together by strong electrostatic force of attraction. The formation of ionic bond between Na and Cl can be shown as follows.

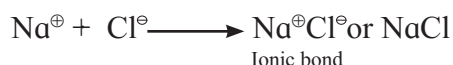

II. Formation of calcium chloride (CaCl_2)

: The following representation shows the formation of compound calcium chloride from the elements calcium and chlorine :

Electronic configuration of

Calcium : $1s^2 2s^2 2p^6 3s^2 3p^4 s^2$

Cl : $1s^2 2s^2 2p^6 3s^2 3p^5$

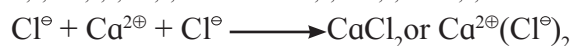

5.1.2 Ionic solids and Lattice Enthalpy :

Ionic solids are solids which contain cations and anions held together by ionic bonds. Kossel treatment helps us to understand the formation of ionic bonds between ions of different elements. Formation of ions depends on the ease with which an atom can lose or gain electrons.

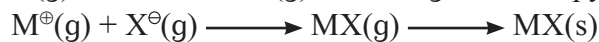
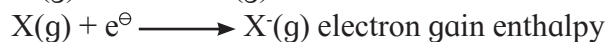

Do you know ?

CsF is the most ionic compound. Because Cs is the most electropositive while F is the most electronegative element. The electronegativity difference between them is the largest. Hence ions are easily separable, the bond is weakest and the compound is least stable ionic compound.

Ionization is always an endothermic process while electron gain process can be exothermic or endothermic. Based on the ionisation enthalpy ($\Delta_i H$) and electron gain enthalpy, we can predict which elements can form ionic compounds.

Elements having low ionization enthalpy can readily form ionic bond with elements having a high negative value of electron gain enthalpy. Both these processes take place in gaseous phase. All ionic compounds in the solid state have each cation surrounded by a specific number of anions and vice versa.

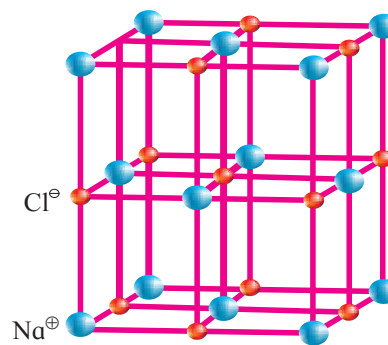

NaCl crystal lattice

The arrangements of cations and anions in a crystalline solid is ordered and they are held together by coulombic forces of attraction. During their formation, these compounds crystallize from the gaseous state ($\text{MX}(\text{g}) \longrightarrow \text{MX}(\text{s})$) to the solid state. The structure in which they crystallize depends upon the size of the ions, their packing arrangement and other factors. The overall stability of the ionic solid depends upon the interactions between all these ions and the energy released during the formation of the crystal lattice.

Let us consider the formation of NaCl ionic solid.

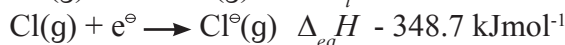
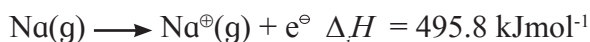

Conversion of $\text{NaCl}(\text{g}) \longrightarrow \text{NaCl}(\text{s})$ is associated with release of energy which is -788 kJ mol^{-1} . This released energy is much more than the absorbed energy. Thus stability of an ionic compound can be estimated by knowing the amount of energy released during lattice formation and not just by energy associated with completion of octet around the ionic species in the gaseous state alone.

Lattice Enthalpy : Lattice Enthalpy of an ionic solid is defined as the energy required to completely separate one mole of solid

ionic compound into the gaseous components. Lattice enthalpy of NaCl is -788 kJ mol^{-1} which means that 788 kJ of energy is required to separate 1 mole of NaCl into one mole of gaseous $\text{Na}^{\oplus}(\text{g})$ and $\text{Cl}^{\ominus}(\text{g})$ to an infinite distance.

Table 5.1 : Lattice Enthalpy values of some ionic Compounds

Compound	Lattice enthalpy kJmol^{-1}
LiCl	853
NaCl	788
BeF_2	3020
CaCl_2	2258
AlCl_3	5492

For same anion and different cations :

1. Cations having higher charge have large lattice energies than compounds having cations with lower charge. $\text{AlCl}_3 > \text{CaCl}_2 > \text{NaCl}$
2. As size of cation decrease, lattice energy increases.
 $\text{LiF} > \text{NaF} > \text{KF}$.

5.2.2 Covalent bond : In 1919 Lewis suggested that there are atoms which attain inert gas configuration (i.e. $1s^2$ or ns^2np^6 configuration) by sharing one or more electron pairs with similar or dissimilar atoms. Each atom contributes one electron to the shared electron pair and has equal claim on the shared electron pair. Langmuir called the Lewis electron pair bond a covalent bond. Thus the concept of covalent bond is known as Lewis Langmuir concept. A shared pair of electron is represented as a dash (–) and is responsible for holding the two atoms together.

A covalent bond may be defined as follows :

The attractive force which exists due to the mutual sharing of electrons between the two atoms of similar electronegativity or having small difference in electronegativities is called a covalent bond.

I. Formation of H_2 molecule : The electronic configuration of H atom is $1s^1$. It needs one more electron to complete its valence shell. When two hydrogen atoms approach each

other at a certain internuclear distance they share their valence electrons. The shared pair of electrons belongs equally to both the hydrogen atoms. The two atoms are said to be linked by a single covalent bond and a molecule H_2 is formed.

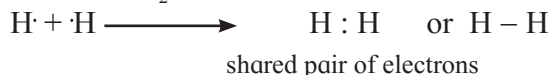

II. Formation of Cl_2 : The Lewis-Langmuir theory can explain the formation of chlorine molecule, Cl_2 . The Cl atom with electronic configuration $[\text{Ne}]3s^23p^5$ is one electron short of Argon configuration. The formation of Cl_2 molecule can be understood in terms of the sharing of a pair of electrons between two chlorine atoms. Each chlorine atom contributes one electron to the shared pair. In the process both the chlorine atoms attain the valence shell octet of the nearest noble gas (i.e. Argon)



The dots represent the electrons. Such structures are referred to as Lewis structures. The Lewis dot structure can be written for other molecules also in which the combining atoms may be identical or different. Following are the important features of covalent bond.

- Each bond is formed as a result of sharing of electron pair between the two atoms.
- When a bond is formed, each combining atom contributes one electron to the shared pair.
- The combining atoms attain the outer shell noble gas configuration as a result of the sharing of electrons.

Thus in H_2O and CCl_4 the formation of covalent bonds can be represented as,

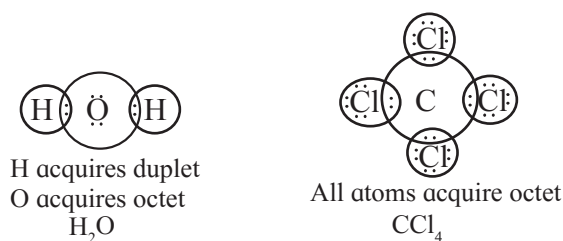

III. Formation of Multiple bond : When two atoms share one electron pair they are said to be joined by a single covalent bond. When two combining atoms share two pairs of electrons, the covalent bond between them is called a double bond. For example a double bond between two carbon atoms in ethylene molecule. When two combining atoms share three electron pairs a triple bond is formed as in the case of two nitrogen atoms in the N_2 molecule [Fig 5.1(a)]. Some other examples of multiple bonds are CO_2 and C_2H_2 [Fig 5.1]

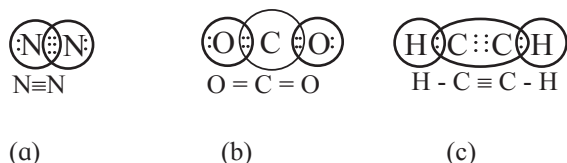

Fig 5.1 Multiple bonding

5.2.3 Lewis structures (Lewis representations of simple molecules) : Lewis dot structures show a picture of bonding in molecules and ions in terms of the shared pairs of electrons and the octet rule. Although such a picture does not explain completely the bonding and behaviour of a molecule, it helps to understand the formation and properties of molecule.

5.3.1 Steps to write Lewis dot structures

1. Add the total number of valence electrons of combining atoms in the molecule.
2. Write skeletal structure of the molecule to show the atoms and number of valence electrons forming the single bond between the atoms.
3. Add remaining electron pairs to complete the octet of each atom.
4. If octet is not complete form multiple bonds between the atoms such that octet of each atom is complete.
5. In anions add one electron for each negative charge.
6. In cations remove or subtract one electron from valence electrons for each positive charge.
7. In polyatomic atoms and ions, the least electronegative atom is the central atom for eg. 'S' is the central atom in SO_4^{2-} , 'N' is the central atom in NO_3^- .

8. After writing the number of electrons as shared pairs forming single bonds, the remaining electron pairs are used either for multiple bonds or remain as lone pairs.

Table 5.2 includes Lewis representation of some molecules.

Table 5.2 Lewis dot structures of some molecules/ions

Molecule/Ion	Lewis Representation
H_2	$H:H, H-H$
O_2	$\ddot{O}::\ddot{O}$
O_3	
NF_3	
CO_3^{2-}	
HNO_3	

Problem 5.1 : To write Lewis structure of nitrite ion NO_2^- .

Solution

Step I : Count the total number of valence electrons of nitrogen atom, oxygen atom and one electron of additional negative charge.

$N(2s^2 2p^3)$, $O(2s^2 2p^4)$

$5 + (2 \times 6) + 1 = 18$ electrons

Step II : The skeletal structure of NO_2^- is written as O N O

Step III : Draw a single bond i.e. one shared electron pair between the nitrogen and each oxygen atoms completing the octet on oxygen atom. This does not complete the octet of nitrogen. Hence, there is a multiple bond between nitrogen and one of the oxygen atoms (a double bond). The remaining two electrons constitute a lone pair on nitrogen. Following are Lewis dot structures of NO_2^- .



Problem 5.2 : Write the Lewis structure of CO molecule.

Solution :

Step - I . Count number of electrons of carbon and oxygen atoms. The valence shell configuration of carbon and oxygen atoms are : $2s^2 2p^2$ and $2s^2 2p^4$ respectively. The valence electrons available are $4 + 6 = 10$

Step - II : The skeletal structure of CO is written as

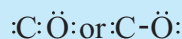

Step - III : Draw a single bond (One shared electron pair) between C and O and complete the octet on O. The remaining two electrons is a lone pair on C.

The octet on carbon is not complete hence there is a multiple bond between C and O (a triple bond between C and O atom). This satisfies the octet rule for carbon and oxygen atoms.

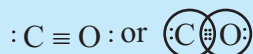

Each H atom attains the configuration of helium (a duplet of electrons)

5.4.1 Formal charge

The Lewis dot diagrams help us to get a picture of bonding in molecules which obey the octet rule. In case of polyatomic molecules double bonds or some times triple bonds are present and can be represented by more than one Lewis structure. In the case of CO_3^{2-} we can have three dot diagrams.

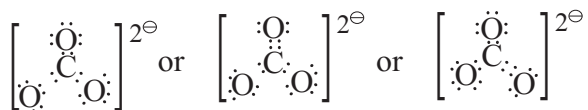

Double bonds can be present between Carbon and any one of the three oxygen atoms. Formal charges can help us in assigning bonds when several structures are possible. Formal charge is the charge assigned to an atom in a molecule, assuming that all electrons are shared equally between atoms, regardless of their relative electronegativities. While determining the best Lewis structure per molecule the structure is chosen such that the

formal charge is as close to zero as possible. Formal charge is assigned to an atom based on electron dot structures of the molecule/ion. e.g. O_3 , NH_4^+ , $[\text{N} = \text{C} = \text{O}]^{\ominus}$, $[\text{S} = \text{C} = \text{N}]^{\ominus}$

Formal charge on an atom in a Lewis structure of a polyatomic species can be determined using the following expression.

$$\left[\begin{array}{l} \text{Formal charge} \\ \text{on an atom in a} \\ \text{Lewis structure} \end{array} \right] = \left[\begin{array}{l} \text{Total no. of} \\ \text{valence electrons} \\ \text{in free atom} \end{array} \right] - \left[\begin{array}{l} \text{Total no. of non} \\ \text{bonding or lone} \\ \text{pairs of electrons} \end{array} \right] - 1/2 \left[\begin{array}{l} \text{Total no. of} \\ \text{bonding or} \\ \text{shared electrons} \end{array} \right]$$

$$\text{or } \text{FC} = \text{VE} - \text{NE} - (\text{BE}/2)$$

The structure having the lowest formal charge has the lowest energy.

1. Let us consider ozone molecule O_3

Lewis structure of O_3 .

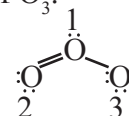

Here three oxygen atoms are numbered as 1, 2, 3. The formal charge on the central oxygen atom no.1 = $6 - 2 - 1/2(6) = +1$

Formal charge on the end oxygen atoms is marked as 2

$$= 6 - 4 - 1/2(4) = 0$$

Formal charge on the end oxygen atoms marked as 3

$$= 6 - 6 - 1/2(2) = -1$$

Hence, O_3 molecule can be represented along with formal charge as follows :

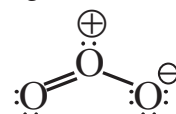

The lowest energy structure can be selected using formal charges from the number of possible Lewis structures, for a given species.

2. Let us take the example of CO_2 .

CO_2 can be represented by the following structures.

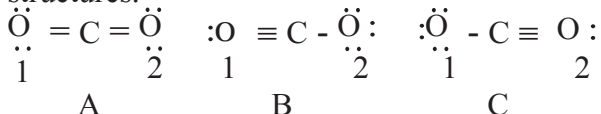

Assigning the formal charges on the carbon atom and the two oxygen atoms numbered 1 and 2

Structure A

Number of electrons: 4 from carbon and 6 from each Oxygen

So total number of electrons = $4 + 6 + 6 = 16$

Formal charge on C = $4 - 0 - 1/2(8) = 0$

Formal charge on O-1 and O-2 = $6 - 4 - 1/2(4) = 0$

In this structure formal charge on all atoms is zero.

Structure B.

Formal charge on C = $4 - 0 - 1/2(8) = 0$

Formal charge on O - 1 = $6 - 2 - 6/2 = 4 - 3 = +1$

Formal charge on O - 2 = $6 - 6 - 2/2 = -1$

Structure C.

Formal charge on C = $4 - 0 - 1/2(8) = 0$

Formal charge on 1st O = $6 - 6 - 2/2 = -1$

Formal charge on 2nd O = $6 - 2 - 6/2 = 4 - 3 = +1$

We find that in structure A the formal charge on all atoms is 0 while in structures B and C formal charge on Carbon is 0 while Oxygens have formal charge -1 or +1. So the possible structure with the lowest energy will be Structure A.



Use your brain power

Which atom in NH_4^{\oplus} will have formal charge +1?

Generally the lowest energy structure has the smallest formal charges on the atoms.

5.4.2 Limitation of octet rule :

1. Octet rule does not explain stability of some molecules.

The octet rule is based on the inert behaviour of noble gases which have their octet complete i.e. have eight electrons in their valence shell. It is very useful to explain the structures and stability of organic molecules. However there are many molecules whose existence cannot be explained by the octet theory. The central atoms in these molecules does not have eight electrons in their valence shell, and yet they are stable. eg. BeCl_2 , PF_5 etc such molecules can be categorized as having

Problem 5.3 :

Find out the formal charges on S, C, N. ($\text{S} = \text{C} = \text{N}$)^o; ($\text{S} - \text{C} \equiv \text{N}$)^o; ($\text{S} \equiv \text{C} - \text{N}$)^o

Solution :

Step I

Write Lewis dot diagrams for the structure



Step II

Assign formal charges

$$\text{FC} = \text{V.E} - \text{N.E} - 1/2 \text{B.E.}$$

Structure A :

Formal charge on S = $6 - 4 - 1/2(4) = 0$

Formal charge on C = $4 - 0 - 1/2(8) = 0$

Formal charge on N = $5 - 4 - 1/2(4) = -1$

Structure B :

Formal charge on S = $6 - 6 - 1/2(2) = -1$

Formal charge on C = $4 - 0 - 1/2(8) = 0$

Formal charge on N = $5 - 2 - 1/2(6) = 0$

Structure C :

Formal charge on S = $6 - 2 - 1/2(6) = +1$

Formal charge on C = $4 - 0 - 1/2(8) = 0$

Formal charge on N = $5 - 6 - 1/2(2) = -2$

i. Incomplete octet

ii. Expanded octet

iii. Odd electrons

i. Molecules with incomplete octet :

eg. BF_3 , BeCl_2 , LiCl

In these covalent molecules the central atoms B, Be and Li have less than eight electrons in their valence shell but are stable.

Li in LiCl has only two electrons

Be in BeCl_2 has four electrons while

B in BF_3 has six electrons in the valence shell.

ii. Molecules with expanded octet : Some molecules like SF_6 , PCl_5 , H_2SO_4 have more than eight electrons around the central atom.

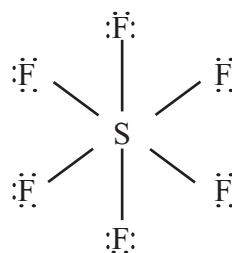

SF_6 ; 12 electrons around sulfur

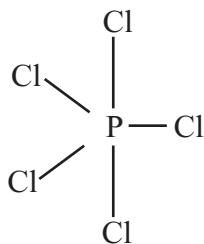

PCl_5 ; 10 electrons around Phosphorus

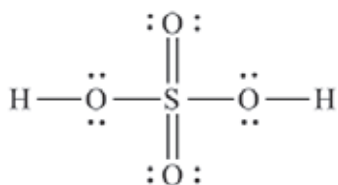

H_2SO_4 ; 12 electrons around sulfur

It must be remembered that sulfur also forms many compounds in which octet rule is obeyed. For example, sulfur dichloride the sulfur atom has eight electrons around it.



SCl_2 8 electrons around sulfur



Use your brain power

How many electrons will be around I in the compound IF_7 ?

iii. Odd electron molecules

Some molecules like NO (nitric oxide) and NO_2 (nitrogen dioxide) do not obey the octet rule. Both N and O atoms, have odd number of electrons.

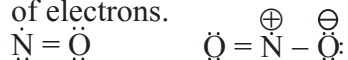

2. The observed shape and geometry of a molecule, cannot be explained, by the octet rule.

3. Octet rule fails to explain the difference in energies of molecules, though all the covalent bonds are formed in an identical manner that is by sharing a pair of electrons. The rule fails to explain the difference in reactivities of different molecules.



Use your brain power

Why is H_2 stable even though it never satisfies the octet rule?

5.5 Valence Shell Electron Pair Repulsion Theory (VSEPR)

Theory (VSEPR) : Properties of substances are dependent on the shape of the molecules. Lewis concept is unable to explain the shapes of molecules. Shapes of all molecules cannot be described completely by any single theory. One of the popular models used earlier to predict the shapes of covalent molecules is the valence shell electron pair repulsion theory proposed by Sidgwick and Powell. It is based on the basic idea that the electron pairs on the atoms shown in the Lewis diagram repel each other. In the real molecule they arrange themselves in such a way that there is minimum repulsion between them.

The arrangement of electrons is called as electron pair geometry. These pairs may be shared in a covalent bond or they may be lone pairs.

Rules of VSEPR :





1. Electron pairs arrange themselves in such a way that repulsion between them is minimum.
2. The molecule acquires minimum energy and maximum stability.
3. Lone pair of electrons also contribute in determining the shape of the molecule.
4. Repulsion of other electron pairs by the lone pair (L.P) stronger than that of bonding pair (B.P)

Trend for repulsion between electron pair is
 $\text{L.P} - \text{L.P} > \text{L.P} - \text{B.P} > \text{B.P} - \text{B.P}$

Lone pair -Lone pair repulsion is maximum because this electron pair is under the influence of only one nucleus while the bonded pair is shared between two nuclei.

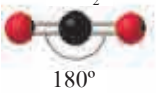
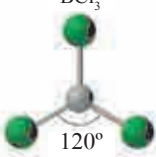
Thus the number of lone pair and bonded pair of electrons decide the shape of the molecules. Molecules having no lone pair of electrons have a regular geometry.

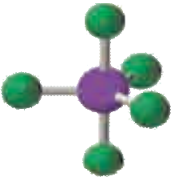
Table 5.3 : Geometry of molecules (having no lone pair of electrons)

Number of electron pairs	Arrangement of electron pairs	Molecular geometry	Examples
2	Linear CO ₂ 	Linear	BeBr ₂ , CO ₂
3	Trigonal planar BCl ₃ 	Trigonal planar	BF ₃ , BCl ₃ , BH ₃
4	Tetrahedral 	Tetrahedral	CH ₄ , NH ₄ ⁺ SiCl ₄
5	Trigonal bipyramidal 	Trigonal bipyramidal	PCl ₅ , SbF ₅ , A ₃ F ₅
6	octahedral 	octahedral	SF ₆ , TeF ₆ , SeF ₆

Depending on the number of lone pair and bonded pairs of electrons the molecules can be represented as AB₂E, AB₃E, AB₂E₂, AB₄D, AB₃E₂, AB₅E, AB₄E₂ where A is the central atom, B - bonded atom E - lone pair of electrons. examples of the above type of molecules are given in table 5.7.

Table 5.4 : Geometry of some molecules (having one or more lone pairs of electrons)

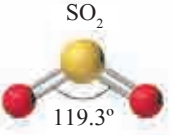
Molecule type	No. of lone pairs	No. of bonding pairs	Arrangement of bonded electron pairs	shape	examples
AB ₂ E	1	2	SO ₂ 	Bent	SO ₂ , O ₃

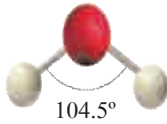
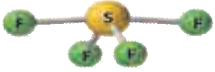
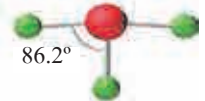
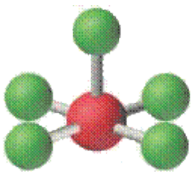
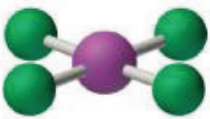
AB_3E	1	3		Trigonal pyramidal	NH_3, PCl_3
AB_2E_2	2	2		Bent	$H_2O, OF_2, H_2S, SCl_2, \text{etc.}$
AB_4E	1	4		See saw	SF_4
AB_3E_2	2	3		T-shape	$ClF_3, BrF_3, ICl_3, \text{etc}$
AB_5E	1	5		square pyramid	BrF_5, IF_5
AB_4E_2	2	4		square planar	XeF_4

The VSEPR theory is therefore able to predict and also explain the geometry of large number of compounds, particularly of p-block elements.

Let us explain the bond angles in NH_3 and H_2O .

1. Ammonia NH_3 : Expected geometry is tetrahedral and bond angle $109^\circ 28'$. Central nitrogen atom has in all 8 electrons in its valence shell, out of which 6 are involved in forming, three N-H covalent bonds the remaining pair forms the lone pair. There are two types of repulsions between the electron pairs.

- i. Lone-pair-bond pair
- ii. Bond pair - bond pair

The lone-pair-bond pair repulsions are stronger and the bonded pairs are pushed inside thus reducing the bond angle to $107^\circ 18'$, and shape of the molecules becomes pyramidal.

2. Water molecule H_2O : The central atom oxygen has six electrons in its valence shell. On bond formation with two hydrogen atoms there are 8 electrons in the valence shell of oxygen. Out of these two pairs are bonded pairs and two are lone pairs.

Due to lone pair - lone pair repulsion the lone pairs are pushed towards the bond pairs and bond pair- Lone pair repulsions becomes stronger thereby reducing the HOH bond angle from the tetrahedral one to $104^\circ 35'$ and the geometry of the molecule is angular.

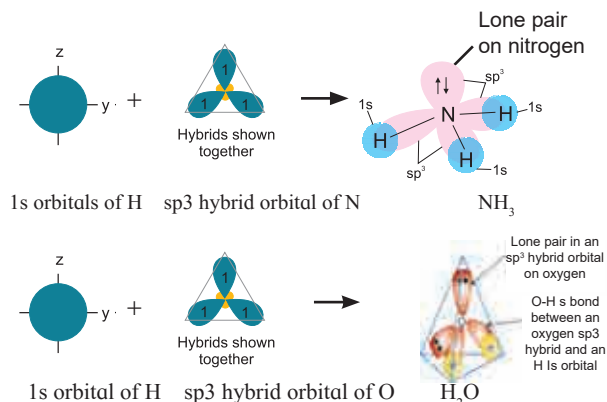

Fig 5.1 : Formation and orbital pictures of NH_3 and H_2O molecules

Advanced theories of Bonding :

The Kossel and Lewis approach to chemical bonding is the first step in understanding the nature of chemical bond. More advanced theories of bonding were put forth to account for the newly discovered properties of compounds in the light of quantum mechanical theory of atomic structures. Two important approaches regarding nature of chemical bond are **valence bond theory** and **molecular orbital theory**.

5.4 Valence Bond Theory :

In order to explain the covalent bonding, Heitler and London developed the valence bond theory on the basis of wave mechanics. This theory was further extended by Pauling and Slater.

5.4.1 Postulates of Valence Bond Theory :

- A covalent bond is formed when the half-filled valence orbital of one atom overlaps with a half filled valence orbital of another atom.
- The electrons in the half-filled valence orbitals must have opposite spins.
- During bond formation the half-filled orbitals overlap and the opposite spins of the electrons get neutralized. The increased electron density decreases the nuclear repulsion and energy is released during overlapping of the orbitals.
- Greater the extent of overlap stronger is the bond formed, however complete overlap of orbitals does not take place due to internuclear repulsions.

- If an atom possesses more than one unpaired electrons, then it can form more than one bond. So number of bonds formed will be equal to the number of half-filled orbitals in the valence shell i.e. number of unpaired electrons.
- The distance at which the attractive and repulsive forces balance each other is the equilibrium distance between the nuclei of the bonded atoms. At this distance the total energy of the bonded atoms is minimum and stability is maximum.
- Electrons which are paired in the valence shell cannot participate in bond formation. However in an atom if there is one or more vacant orbital present then these electrons can unpair and participate in bond formation provided the energies of the filled and vacant orbitals differ slightly from each other.
- During bond formation the 's' orbital which is spherical can overlap in any direction. The 'p' orbitals can overlap only in the x, y or z directions. [similarly 'd' and 'f' orbitals are oriented in certain directions in space and overlap only in these direction]. Thus the covalent bond is directional in nature.

5.4.2 Interacting forces during covalent bond formation :

By now we have understood that a covalent bond is formed by the overlap of two half filled atomic orbitals and the bonded atoms are stable than the free atoms and the energy of the bonded atoms is less than that of free atoms. So lowering of energy takes during bond formation. How does this happen ?

This happens due to interactive forces which develop between the nuclei of the two atoms and also their electrons. These forces may be attractive and repulsive between nuclei of A and electrons of B and those arising from attraction between nuclei of atom A and electrons of B and the repulsion between electrons.

The balance between attractive and repulsive forces decide whether the bond will be formed or not.

When the attractive forces are stronger than the repulsive forces overlap takes place between the two half filled orbitals a bond is formed and energy of the system is lowered.

This lowering of energy during bond formation is depicted in the potential energy diagram. To understand this let us consider the formation of H_2 molecule from atoms of hydrogen each containing one unpaired electrons. When the two atoms are far away from each other there are no interactions between them. The energy of the system is the sum of the potential energies of the two atoms which is arbitrarily taken as zero.

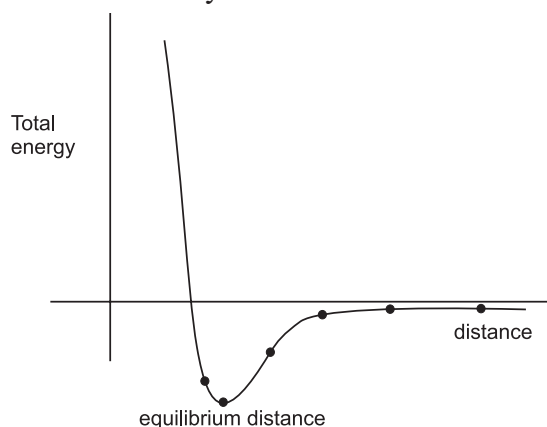

Fig. 5.2 : Potential energy diagram for formation hydrogen molecule

Repulsive forces stabilize the system with increase energy of the system while attractive forces decrease the energy. Experimentally it has been found that during formation of hydrogen molecule the magnitude of the newly developed attractive forces contribute more than the newly developed repulsive forces. As a result the potential energy of the system begins to decrease.

As the atoms come closer to one another the energy of the system decreases. The overlap increases only upto a certain distance between the two nuclei, where the attractive and repulsive forces balance each other and the system attains minimum energy (see Fig 5.3). At this stage a bond is formed between the two atoms of hydrogen. If the two atoms are further pushed closer to each other the repulsive forces become more predominant and the energy of the system starts increasing

and stability decreases. (See Fig. 5.2 potential energy diagram)

If atoms containing electrons with parallel spins are brought close to each other, the potential energy of the system increases and bond formation does not take place.

5.4.3 Overlap of atomic orbitals : Formation of a bond has been explained on the basis of overlap of atomic orbital having same energy and symmetry. In the preceding section, we have seen that the strength of the bond depends on the extent of overlap of the orbitals. Greater the overlap stronger is the bond.

The orbitals holding the electrons vary in shape, energy and symmetry. So the extent of overlap depends on the shape and size of the orbital

On the basis of the above considerations we have 2 types of bonds.

- i. sigma bond (σ)
- ii. pi bond (π)

i. Sigma Bond :

When the overlap of the bonding orbitals is along the internuclear axis it is called as sigma overlap or sigma bond.

The σ bond is formed by the overlap of following orbitals.

- a. Two 's' orbitals
- b. One 's' and one p_z orbital
- c. Two 'p' orbitals

a. s-s overlap : eg. H_2

The $1s^1$ orbitals of two hydrogen atoms overlap along the internuclear axis to form a σ bond between the atoms in H_2 molecule. electronic configuration of H : $1s^1$

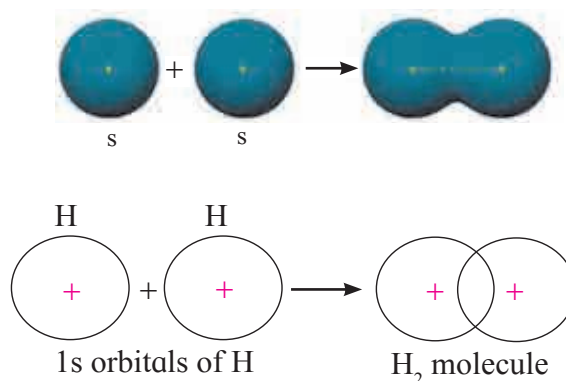

b. p-p overlap

This type of overlap takes place when two p orbitals from different atoms overlap along the internuclear axis eg. F_2 molecule.

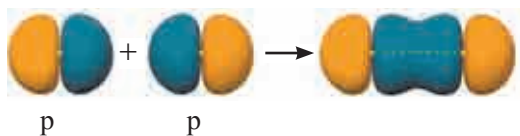

Electronic configuration of fluorine $1s^2, 2s^2, 2p_x^2, p_y^2, p_z^1$. The $2p_z$ orbitals of the fluorine atoms overlaps along internuclear axis to form p-p σ overlap.

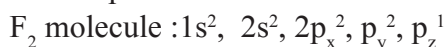

c. s-p σ bond

In this type of overlap one half filled 's' orbital of one atom and one half filled 'p' orbital of another orbital overlap along the internuclear axis. eg. HF molecule

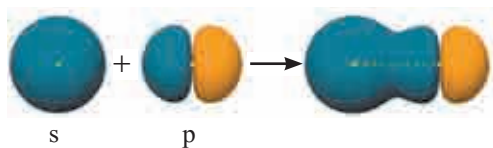

Electronic configuration :

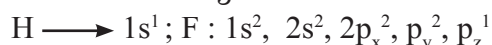

$1s^1$ orbital of hydrogen and $2p_z^1$ of fluorine overlap to form s - p σ overlap.

ii. p-p overlap/ π overlap/ π bond :

When two half filled orbitals of two atoms overlap side ways (laterally) it is called π overlap and it is perpendicular to the internuclear axis.

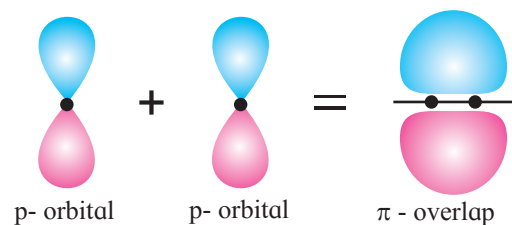

5.4.4 Hybridization : The valence bond theory explained well the formation of covalent bond by the overlap of orbitals in case of simple molecules like $H_2, F_2, H-F$ etc. Accordingly the maximum number of covalent bonds which an atom can form equals the number of unpaired electrons present in its valence shell. But the theory does not explain how beryllium forms two covalent bonds or how boron shows

trivalency, carbon shows tetravalency in spite of their electronic configuration e.g. BeH_2, BF_3, CH_4, CCl_4 etc.

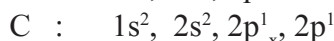
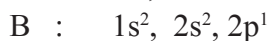
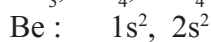

In order to explain the observed valency in these and such other compounds a concept of hybridization was put forward.

It was suggested that one electron in '2s' orbital is promoted to the empty '2p' orbital. Thus in the excited state Be, B and C have two, three and four half filled orbitals, respectively.

Electronic configurations in excited state :

	1s	2s	2p
Be	$\uparrow\downarrow$	\uparrow	$\uparrow \quad \square \quad \square$
B	$\uparrow\downarrow$	\uparrow	$\uparrow \quad \uparrow \quad \square$
C	$\uparrow\downarrow$	\uparrow	$\uparrow \quad \uparrow \quad \uparrow$

In the excited state Be, B and C have 2, 3 and 4 half filled orbitals. So Be, B and C can form 2, 3 and 4 bonds respectively. This concept helps to understand how Be forms 2 bonds whereas B and C form 3 and 4 bonds, respectively but it cannot explain how all bonds have same bond length and bond strength.

For example, in BeF_2 beryllium will use one s and one half-filled p orbitals to overlap with two half filled 'p' orbitals on fluorine, so in the molecule there will be one s-p bond and one p-p bond. which will not be of equal strength, but actually both Be-F bonds are of the same strength. Similar situation is seen in BF_3, BH_3, CH_4, CCl_4 . In CH_4 all bonds are of equal strength although the overlaps are between s, p_x, p_y, p_z orbitals of carbon and 's' orbital of hydrogen, experimentally all C-H bond lengths bond strengths and bond angles are found to be identical.

This can be explained using another concept. "**Hybridization**" in the valence bond theory. This concept helps to explain the observed structural properties of many molecules.

Hybridization refers to mixing of valence orbitals of same atom and recasting them into equal number of new equivalent orbitals-**Hybrid orbitals.**

Steps considered in Hybridization

- Formation of excited state
- Mixing and Recasting of orbitals

i. Formation of the excited state : The paired electrons in the ground state are uncoupled and one electron is promoted to the a vacant orbital having slightly higher energy. Now total number of half filled orbitals is equal to the valency of the element in the stable compound. e.g. in BeF_2 , valency of Be is two. In the excited state one electron from 2s orbital is uncoupled and promoted to 2p orbital.

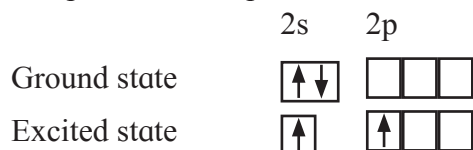

ii. Mixing and Recasting : In this step the two 's' and 'p' orbitals having slightly different energies mix with each other. Redistribution of electron density and energy takes place and **two new orbitals having exactly same shape and energy are formed.**

These new orbitals arrange themselves in space in such a way that there is minimum repulsion and maximum separation between them.

So during formation of sp hybrid orbitals as in Be the two sp hybrid orbitals are 180° .

Conditions for hybridization :

- Orbitals belonging to the same atom can participate in hybridization.
- Orbitals having nearly same energy can undergo hybridization, so 2s and 2p orbitals undergo hybridization but 3s and 2p orbitals do not.

Characteristic features of hybrid orbitals :

- Number of hybrid orbitals formed is exactly the same as the participating atomic orbitals.
- They have same energy and shape.
- Hybrid orbitals are oriented in space in such a way that there is minimum repulsion and thus are directional in nature.
- The hybrid orbitals are different in shape from the participating atomic orbitals, but they bear the characteristics of the atomic orbitals from which they are derived.
- Each hybrid orbitals can hold two electrons with opposite spins.

- A hybrid orbital has two lobes on the two sides of the nucleus. One lobe is large and the other small.
- Covalent bonds formed by hybrid orbitals are stronger than those formed by pure orbitals, because the hybrid orbital has electron density concentrated on the side with a larger lobe and the other is small allowing greater overlap of the orbitals.

5.4.5 Types of Hybridization and Geometry of Molecules : Different types of hybrid orbitals are obtained from the atomic orbitals that participate in hybridization.

s and p orbitals can hybridize to form the following hybrid orbitals

- sp^3
- sp^2
- sp

i. sp^3 Hybridization : In this type one 's' and three 'p' orbitals having comparable energy mix and recast to form four sp^3 hybrid orbitals. It should be remembered that 's' orbital is spherically symmetrical while the p_x , p_y , p_z orbitals have two lobes and are directed along x, y and z axes, respectively.

The four sp^3 hybrid orbitals formed are equivalent in energy. and shape. They have one large lobe and one small lobe. They are at an angle of $109^\circ28'$ with each other in space and point towards the corners of a tetrahedron CH_4 , NH_3 , H_2O are examples where the orbitals on central atom undergo sp^3 hybridization.

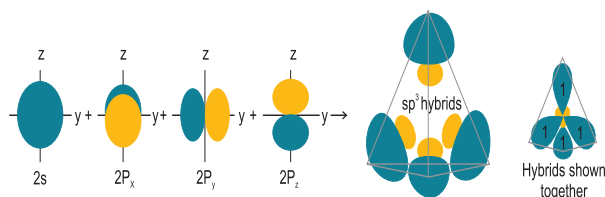

Fig 5.3 : Formation of sp^3 hybrid orbitals

Formation of methane (CH_4) molecule :

Ground state electronic configuration of Carbon is $1s^2, 2s^2, 2p_x^1, p_y^1, p_z^0$. In order to form four equivalent bonds with hydrogen the 2s and 2p orbitals undergo hybridization.

Electronic configuration of carbon	1s	2s	2p
Ground state	$\uparrow\downarrow$	$\uparrow\downarrow$	$\uparrow\uparrow\ \square$
Excited state	$\uparrow\downarrow$	\uparrow	$\uparrow\uparrow\uparrow$
sp^3 Hybrid orbitals	$\uparrow\downarrow$	$\uparrow\uparrow\uparrow\uparrow$ (four sp^3 hybrid orbitals.)	

One electron from the 2s orbital of Carbon atom is excited to the $2p_z$ orbital. Then the four orbitals 2s, p_x , p_y , p_z mix and recast to form four new sp^3 hybrid orbitals having same shape and equal energy. They are maximum apart and have tetrahedral geometry. Each hybrid orbital contains one unpaired electron.

Each of these sp^3 hybrid orbitals with one electron overlap axially with the 1s orbital of hydrogen atom to form one C-H sigma bond. Thus in CH_4 molecule we have four C-H bonds formed by the sp^3 -s overlap.

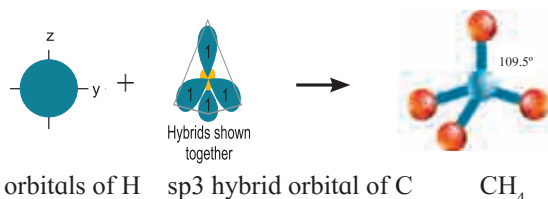

ii. sp^2 Hybridization : This hybridization involves the mixing of one s and two p orbitals to give three sp^2 hybrid orbitals of same energy and shape. The three orbitals are maximum apart and oriented at an angle of 120° and are in one plane. The third p orbital does not participate in hybridization and remains at right angles to the plane of the sp^2 hybrid orbitals. BF_3 , C_2H_4 molecules are examples of sp^2 hybridization.

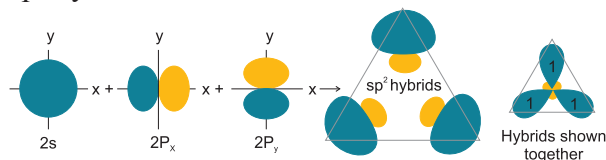

Fig 5.4 : Formation of sp^2 hybrid orbitals

Formation of C_2H_4 molecule : This molecule contains two carbon atoms each bound to two hydrogen. Each carbon atom undergoes sp^2 hybridization. One 's' orbital and two 'p' orbitals on carbon hybridize to form three sp^2 hybrid orbitals of equal energy and symmetry.

Two sp^2 hybrid orbitals overlap axially two 's' orbitals of hydrogen to form sp^2 -s σ bond. The unhybridized 'p' orbitals on the two carbon atoms overlap laterally to form a lateral π overlap. Thus the C_2H_4 molecule has four sp^2 -s σ bonds. One sp^2 - sp^2 σ bond one p-p π bond.

Electronic configuration of carbon

	1s	2s	2p
Ground state	$\uparrow\downarrow$	$\uparrow\downarrow$	$\uparrow\uparrow\ \square$
Excited state	$\uparrow\downarrow$	\uparrow	$\uparrow\uparrow\uparrow$
sp^2 Hybridized	$\uparrow\downarrow$	$\uparrow\uparrow\uparrow$ sp^2 hybrid orbitals pure 'p' orbital	

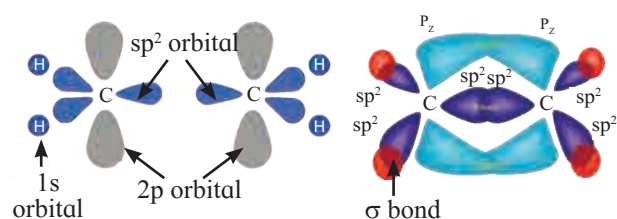

Formation of Boron trifluoride (BF_3) molecule :

1. Need of hybridisation : Observed valency of boron in BF_3 is three and its geometry is triangular planar which can be explained on the basis of sp^2 hybridisation.
2. sp^2 hybridisation of Boron atom : In BF_3 molecule central boron atom undergoes sp^2 hybridisation. The ground state electronic configuration of Boron ($z = 5$) is $1s^2 2s^2 2p_x^1 2p_y^1 2p_z^0$

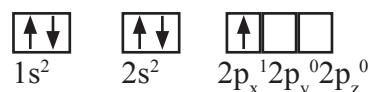

To explain valency of boron in BF_3 one electron from 2s orbital of boron atom is uncoupled and promoted to vacant $2p_y$ orbital. Thus excited state electronic configuration of boron becomes $s^2 2s^2 2p_x^1 2p_y^1 2p_z^1$

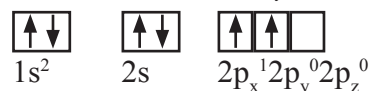

The three orbitals i.e. 2s, $2p_x$ of and $2p_y$ of boron undergoes sp^2 hybridisation to form three sp^2 hybrid orbitals of equivalent energy which are oriented along the three corners of an equilateral triangle making an angle of 120° .

Thus boron in hybridised state has electronic following configuration.



3. orbital overlap : Each sp^2 hybrid orbital of boron atom having unpaired electron overlaps axially with half filled $2p_z$ orbital of fluorine atom containing electron with opposite spin to form three B-F sigma bond by sp^2 -p type of overlap.
4. Bond angle : Each F-B-F bond angle in BF_3 molecule is 120° .
5. Geometry : The geometry of BF_3 molecule is trigonal planar.

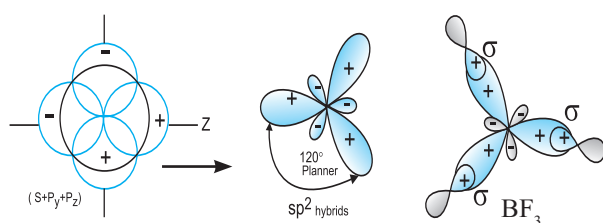

iii. sp hybridization : In this type one 's' and one 'p' orbital undergo mixing and recasting to form two sp hybrid orbitals of same energy and shape. The two hybrid orbitals are placed at an angle of 180° . Other two p orbitals do not participate in hybridization and are at right angles to the hybrid orbitals. For example : $BeCl_2$ and acetylene molecule $HC \equiv CH$,

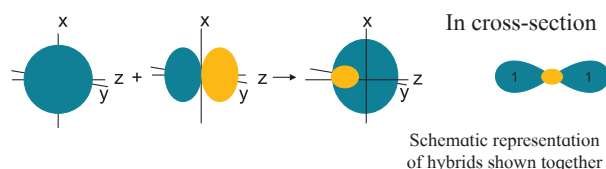

Fig 5.5 : formation of sp hybrid orbitals

Formation of acetylene molecule : This molecule contains two carbon and two hydrogen atoms. Each carbon atom undergoes sp hybridization. One s and one p orbitals mix and recast to give two sp hybrid orbitals arranged at 180° to other.

Out of the two sp hybrid orbitals of carbon atom one overlaps axially with 's' orbital of hydrogen while the other sp hybrid orbital overlaps with sp hybrid orbital of other carbon atom to form the sp-sp σ bond. The C-H σ bond is formed by sp-s overlap.

The remaining two unhybridized p orbitals overlap laterally to form two p-p π bonds. So there are three bonds between the two carbon atoms : one C-C σ bond (sp-sp) overlap, two C-C π bonds (p-p) overlap and fourth sp-s σ bond between C and H satisfy the fourth valency of carbon.

Electronic configuration of carbon

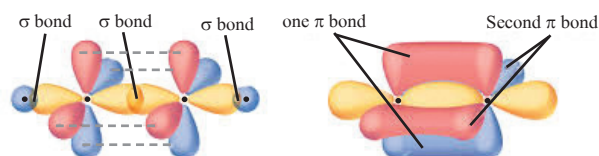
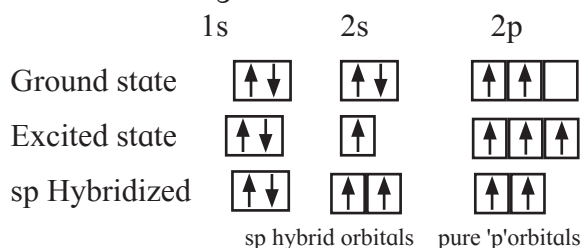

5.4.6 Importance and limitation of valence bond theory

Importance of valence bond theory (V.B)

V.B. theory introduced five new concepts in chemical bonding.

- i. Delocalization of electron over the two nuclei.
- ii. shielding effect of electrons.
- iii. covalent character of bond.
- iv. partial ionic character of a covalent bond.
- v. The concept of resonance and connection between resonance energy and molecular stability.

5.4.7 Limitations of valence bond theory

i. V.B. Theory explains only the formation of covalent bond in which a shared pair of electrons comes from two bonding atoms.

However, it offers no explanation for the formation of a co-ordinate covalent bond in which both the electrons are contributed by one of the bonded atoms.

ii. Oxygen molecule is expected to be diamagnetic according to this theory. The two atoms in oxygen molecule should have completely filled electronic shells which give no unpaired electrons to the molecule making it diamagnetic. However, experimentally the molecule is found to be para-magnetic having

two unpaired electrons. Thus, this theory fails to explain paramagnetism of oxygen molecule.

Problem 5.4

Explain the formation of BeCl_2

Electronic configuration of beryllium

	1s	2s	2p
Ground state	$\uparrow\downarrow$	$\uparrow\downarrow$	$\square \square \square$
Excited state	$\uparrow\downarrow$	\uparrow	$\uparrow \square \square$
sp Hybridized	$\uparrow\downarrow$	$\uparrow \uparrow$	$\square \square$
		sp hybrid orbitals	pure 'p' orbitals

Formation of BeCl_2 molecule.

This molecule has one Be atom and two chlorine atoms. Electronic configuration of Be is $1s^2, 2s^2, 2p_z^0$. The 2s and $2p_z$ orbitals undergo sp hybridization to form two sp hybrid orbitals oriented at 180° with each other. $2p_z$ orbitals of two chlorine atoms overlap with the sp hybrid orbitals to form two sp-p σ bond.

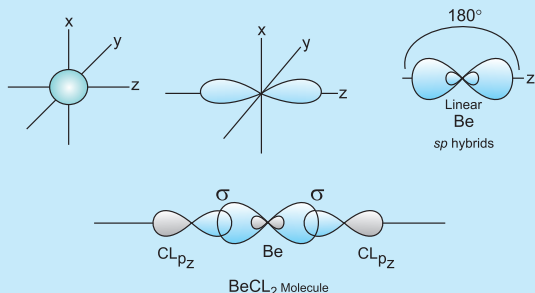

iii. Valence bond theory does not explain the bonding in electron deficient molecules like B_2H_6 in which the central atom possesses less number of electrons than required for an octet of electron.

5.5 Molecular orbital theory : You are familiar with the valence bond theory which describes the formation of covalent bonds by overlap of half filled atomic orbitals. This theory is successful to give satisfactory electronic description for a large number of molecules. In some cases it gives to incorrect electronic description. Therefore another bonding description called Molecular Orbital Theory (MO) has been introduced.

It has been found that the MO theory gives more accurate description of electronic structure of molecules.

The concept of an orbital is introduced by quantum mechanics. The quantum mechanical wave equation is a differential equation and its solution is called wave function. The square of the wavefunction gives a measure of probability of finding an electron within a certain region of space of an atom. It is nothing but an atomic orbital.

MO theory does not concentrate on individual atoms. It considers the molecule as a whole rather than an atom for the bonding. Accordingly a molecular orbital MOT is the property of a molecule similar to what an atomic orbital is to an atom. Hence, molecular orbital can be depicted through a square of wavefunction that gives the probability of finding an electron within a certain region of space in a molecule. Like atomic orbitals, molecular orbitals have energy levels and definite shapes. They also contain maximum two electrons with opposite spins.

5.5.1 Formation of molecular orbitals :

According to the MO theory the formation of molecular orbitals from atomic orbitals is expressed in terms of Linear Combination of Atomic Orbitals (LCAO). Formation of molecular orbitals can be understood by considering the interference of the electron waves of combining atoms. Interference of electron waves can be constructive or destructive i.e. the waves can reinforce each other or cancel each other. So we can say that. Two atomic orbitals combine in two ways to form molecular orbitals. 1. By addition of their wave functions. 2. By subtraction of their wave functions. Addition of the atomic orbitals wave functions results in formation of a molecular orbital which is lower in energy than atomic orbitals and is termed as Bonding Molecular Orbital (BMO). Subtraction of the atomic orbitals results in the formation of a molecular orbital which is higher in energy than the atomic orbitals and is termed as Antibonding Molecular Orbital (AMO).

In bonding molecular orbital the large electron density is observed between the nuclei of the bonding atoms than the individual atomic orbitals. On the other hand in the antibonding orbital the electron density is nearly zero between the nuclei.

So placing an electron in bonding orbital leads to formation of a covalent bond. While placing electron in antibonding orbital makes the bond unstable.

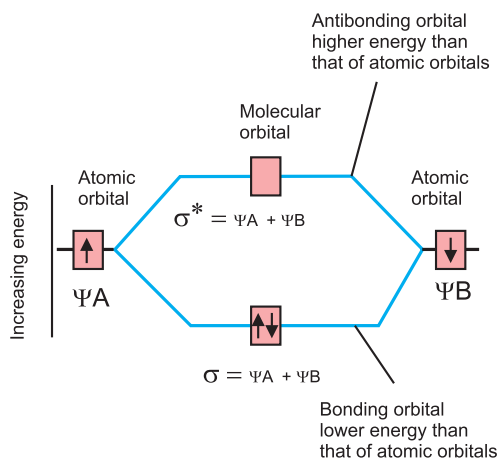

Fig. 5.5 : formation of MOs

5.5.2 Conditions for the combination of Atomic Orbitals : Atomic orbitals can be combined linearly which give molecular orbitals only if following conditions are fulfilled.

- The combining atomic orbitals must have comparable energies.
So 1s orbitals of one atom can combine with 1s orbital of another atom but not with 2s orbital, because energy of 2s orbital is much higher than that of 1s orbital.
- The combining atomic orbitals must have the same symmetry along the molecular axis. Conventionally z axis is taken as the internuclear axis. So even if atomic orbitals have same energy but their symmetry is not same they cannot combine. For example, 2s orbital of an atom can combine only with 2p_z orbital of another atom, and not with 2p_x or 2p_y orbital of that atom because the symmetries are not same. p_z is symmetrical along z axis while p_x is symmetrical along x axis.
- The combining atomic orbitals must overlap to the maximum extent. Greater

the overlap, greater is the electron density between the nuclei and so stronger is the bond formed.

5.5.3 Types of molecular orbitals : In diatomic molecules, molecular orbitals formed by combination of atomic orbitals are of two types (i) σ (ii) π.

According to this nomenclature a σ designates a molecular orbital which is symmetrical around the bond axis and π designates a molecular orbitals those are unsymmetrical.

This is clear if we consider a linear combination of i. two 's' orbitals ii. two p orbitals.

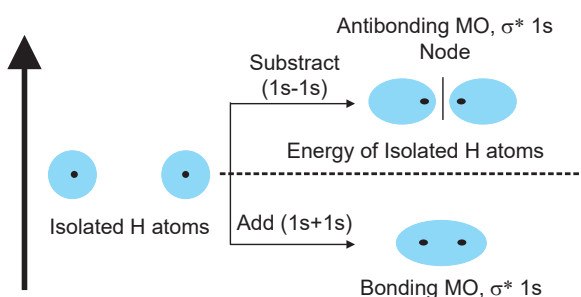

Fig 5.6 : Linear combination of two s orbitals

- The s orbitals are spherically symmetric along x, y and z axes, combination of two '1s' orbitals centred on two nuclei of two atoms, led to two σ molecular orbitals which are symmetrical along the bond axis. One of which is σ bonding and other σ* antibonding (Fig. 7)
- If we consider 'z' to be internuclear axis then linear combination of p_z orbitals from two atoms can form σ 2p_z bonding σ*(2p_z) molecular orbitals.

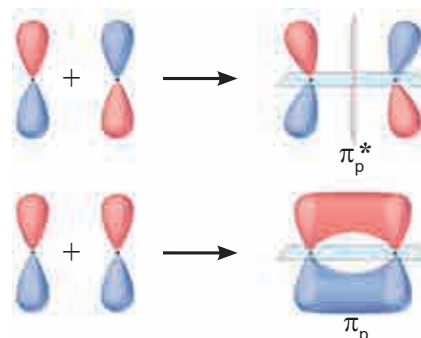

Fig 5.7 : Formation of π and π* molecular orbitals

The p_x , p_y orbitals are not symmetrical along the bond axis, they have a positive lobe above the axis and negative lobe below the axis. Hence linear combination of such orbitals leads to the formation of molecular orbitals with positive and negative lobes above and below the bond axis. These are designed as π bonding and π antibonding orbitals. The electron density in such π orbitals is concentrated above and below the bond axis. The π molecular orbitals has a node between the nuclei (fig. 5.9)

5.5.4 Energy levels and electronic configuration : We have seen earlier that on combination of two 1s orbitals; two molecular orbitals σ 1s and σ^* 1s are formed. Similarly two 2s orbitals yield σ^* 2s and σ 2s molecular orbitals.

The three 2p orbitals on one atom combine with three 2p orbitals on another atom forming six molecular orbitals, designated as σ 2p_z, π p_x, π p_y and σ^* 2p_z, π^* p_x, π^* p_y

The molecular orbitals in homonuclear diatomic molecules have been determined experimentally.

For diatomic molecules of second row elements except O₂ and F₂ the rank order of energies is σ 1s < σ^* 1s < σ 2s < σ^* 2s < π 2p_x = π 2p_y < σ 2p_z < (π^* 2p_y = π^* 2p_x) < σ^* 2p_z

For O₂ and F₂ increasing order of energies was found to be :

σ 1s < σ^* 1s < σ 2s < σ^* 2s < σ 2p_z < (π 2p_x = π 2p_y) < π^* 2p_x < π^* 2p_y < σ^* 2p_z

The sequence of filling the molecular orbitals give electronic configuration of molecules. The electronic configuration of molecules provides the following information.

a. Stability of molecules : If the number of electrons in bonding MOs is greater than the number in antibonding MOs the molecule is stable.

b. Magnetic nature of molecules : If all MOs in a molecule are completely filled with two electrons each, the molecule is diamagnetic (i.e. repelled) by magnetic field.

However, if at least one MO is half filled with one electron, the molecule is paramagnetic (i. e. attracted by magnetic field).

c. Bond order of molecule : The bond order of the molecule can be calculated from the number of electrons in bonding N_b and antibonding MOs (N_a).

$$\text{Bond order} = \frac{N_b - N_a}{2}$$

5.5.5 Key ideas of MO theory :

- MOs in molecules are similar to AOs of atoms. Molecular orbital describes region of space in the molecule representing the probability of an electron.
- MOs are formed by combining AOs of different atoms. The number of MOs formed is equal to the number of AOs combined.
- Atomic orbitals of comparable energies and proper symmetry combine to form molecular orbitals.
- MOs those are lower in energy than the starting AOs are bonding (σ) MOs and those higher in energy are antibonding (σ^*) MOs.
- The electrons are filled in MOs beginning with the lowest energy.
- Only two electrons occupy each molecular orbital and they have opposite spins that is, their spins are paired.
- The bond order of the molecule can be calculated from the number of bonding and antibonding electrons.

5.5.6 MO description of simple diatomic Molecules

1. Hydrogen molecule.-H₂

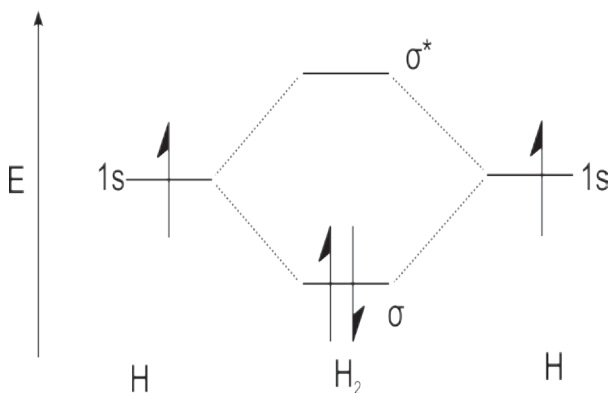

Fig. 5.8 : MO diagram for H₂ molecule

Hydrogen molecule is formed by the linear combination of two Hydrogen atoms, each having one electron in its 1s orbital. Linear combination of two 1s orbitals gives two molecular orbitals σ_{1s} and σ^*_{1s} . The two electrons from the hydrogen atoms occupy the σ_{1s} molecular orbital and σ^*_{1s} remains vacant.

Electronic configuration of Hydrogen molecule is written as σ_{1s}^2

Bond order = (bonding electron – antibonding electrons) ÷ 2

For hydrogen Bond order = (2-0) ÷ 2 = 1

So in H_2 molecule there exists one covalent bond between the two hydrogen atoms. The bond length is 74 pm and the bond dissociation energy is 438 kJ mol. As there are no unpaired electrons present the H_2 molecule is diamagnetic.

2. Lithium molecule. Li_2 :

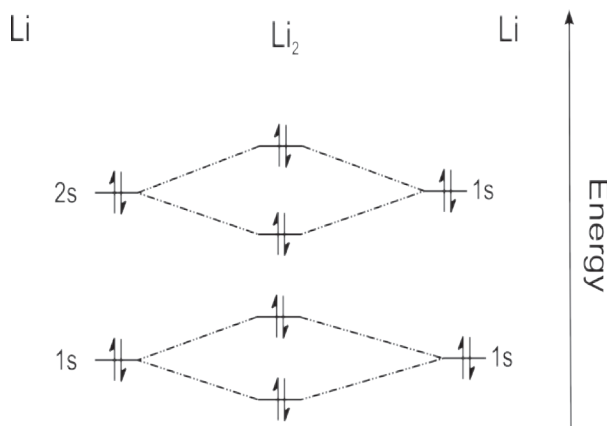

Fig. 5.9 : MO diagram for Li_2

Each Lithium atom has 3 electrons with electronic configuration $1s^2, 2s^1$, so Li_2 molecule will have 6 electrons. Linear combination of atomic orbitals gives four molecular orbitals σ_{1s} , σ^*_{1s} , σ_{2s} , σ^*_{2s}

Electronic configuration of Li_2 molecule will be $(\sigma_{1s})^2, (\sigma^*_{1s})^2, (\sigma_{2s})^2$

Bond order = (4-2) ÷ 2 = 1,

This means in Li_2 molecule there is one bond between the two Lithium atoms. Such Li_2 molecules are found in the vapour state. As there are no unpaired electrons the molecule is diamagnetic.

3. N_2 molecule :

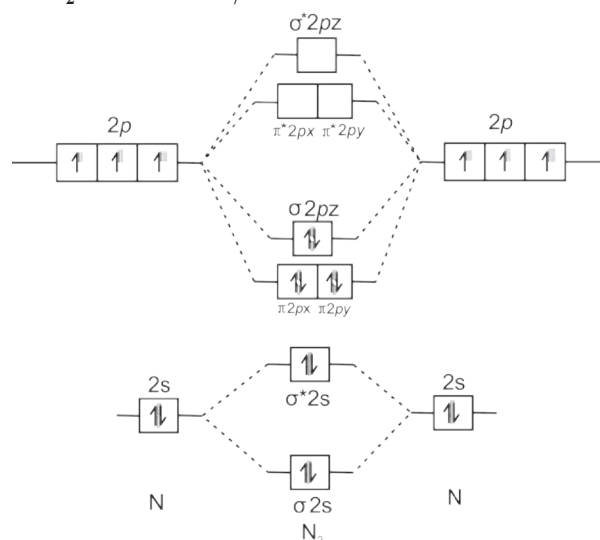

Fig. 5.10 : MO diagram for N_2

$N : 1s^2 2s^2 2p^3$

Electronic configuration of N_2 molecule (14 electrons) is

$(\sigma_{1s})^2 (\sigma^*_{1s})^2 (\sigma_{2s})^2 (\sigma^*_{2s})^2 (\pi_x)^2 (\pi_y)^2 (\sigma_{2p_z})^2$

Bond order of N_2 molecule = $\frac{10-4}{2} = 3$

N_2 molecule is diamagnetic.

4. O_2 molecule :

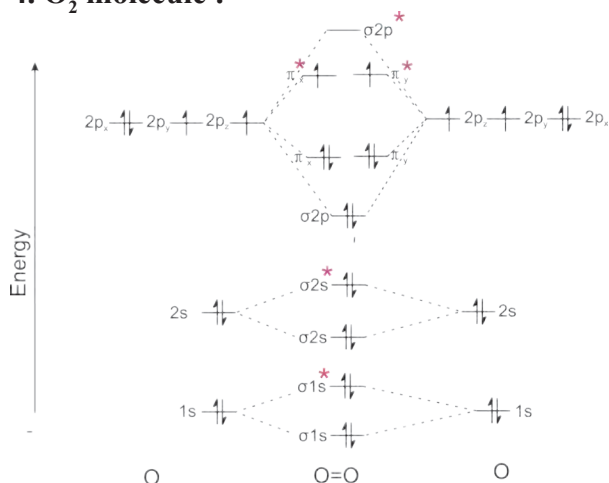

Fig. 5.11 : MO diagram for O_2

$O : 1s^2 2s^2 2p^4$

The electronic configuration of O_2 molecule (16 electrons) is

$(\sigma_{1s})^2 (\sigma^*_{1s})^2 (\sigma_{2s})^2 (\sigma^*_{2s})^2 (\pi_x)^2 (\pi_y)^2 (\sigma_{2p_z})^2 (\pi^*_x)^2 (\pi^*_y)^2$

Bond order of O_2 molecule = $\frac{10-6}{2} = 2$

O₂ molecule is paramagnetic due to presence of 2 unpaired electrons in the π* orbitals.

5. F₂ molecule :

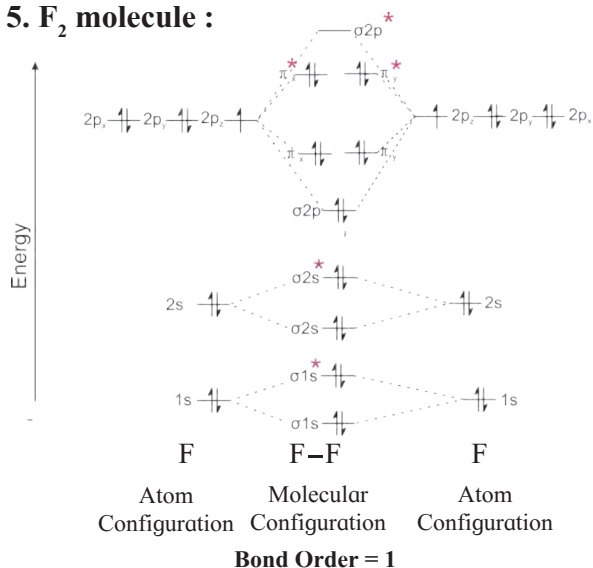
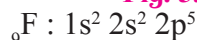

Fig. 5.12 : MO diagram for F₂



The electronic configuration of F₂ molecule (18 electrons) is (σ 1s)² (σ* 1s)² (σ 2s)² (σ* 2s)² (π_x)² (π_y)² (σ_z)² (π*_x)² (π*_y)²

$$\text{Bond order of F}_2 \text{ molecule} = \frac{10 - 8}{2} = 1$$

F₂ molecule is diamagnetic



Can you tell?

Why He₂ molecule is not stable?
Draw MO diagram for it

5.6 Parameters of covalent bond : A covalent bond is characterised by different parameters. These parameters help to understand how strong is the bond between the two atoms, what is the distance between them and what is the shape of the molecule.

5.6.1 Bond angle : The electrons which participate in bond formation are present in orbitals. The angle between the orbitals holding the bonding electrons is called the bond angle.

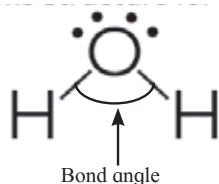

Bond angle can be determined experimentally using spectroscopic techniques. Value of bond angle gives an idea about the arrangement of orbitals around the central atom and the shape of the molecule.

Table 5.5 bond angles of some molecules

	Molecule	Bond of angle
1	H ₂ O	104°28 ¹
2	NH ₃	107
3	BF ₃	120

5.6.2 Bond Enthalpy : The amount of energy required to break one mole of bond of one type, present between two atoms in the gaseous state is termed as Bond Enthalpy. For diatomic molecules the dissociation energy is the same as bond enthalpy. Bond enthalpy for H₂ molecule is 435.8 kJ mol⁻¹. The bond enthalpy is a measure of strength of the bond between two atoms and can be measured experimentally. N-N bond in N₂ is stronger than the O-O bond in O₂. Larger is the bond dissociation energy stronger is the bond in the molecule. For heteronuclear diatomic molecule HCl the bond enthalpy was found to be 431.0 kJ mol⁻¹.

In case of polyatomic molecules the bond enthalpy and bond dissociation energy are not identical. Bond enthalpy is the average of the sum of successive bond dissociation energies. For example dissociation of water.

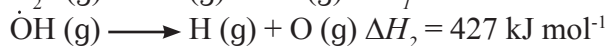

Average bond enthalpy of O-H bond in H₂O :

$$\Delta_{\text{a}}H = \frac{502 + 427}{2} = 464.5 \text{ kJmol}^{-1}.$$

In both the above equations the bond between O and H is broken but the amount of energy required to break the bond is different, i.e. enthalpies of two O-H bonds in water are different.

This difference arises due to the fact that cleavage of the two O-H bonds in water takes place in two steps. In the first step one O-H bond breaks leaving behind OH radical. Now the electronic environment around oxygen to

which hydrogen is attached is different than that around oxygen in H_2O molecule and this causes a change in the successive bond dissociation energy.

Same difference is observed in enthalpy values of O-H bond in $\text{C}_2\text{H}_5\text{OH}$. Oxygen here is attached to C_2H_5 group therefore hydrogen of O-H is in different environment than hydrogen of H-O-H.

In the same way, the bond enthalpy value of any covalent bond is slightly different for each bond of that kind in a given molecule and also different molecules. The average values of bond enthalpy, $\Delta_f H$, are determined from the experimentally measured values of large number of compounds containing a particular bond. Average bond enthalpy data are given in Table 5.4. In general stronger bond implies larger bond enthalpy.



Do you know ?

Among diatomic molecules the bond order and bond enthalpy of N_2 is highest. Bond order = 3, Bond enthalpy = 946 kJ mol^{-1}

Table 5.6 Bond enthalpies

Bond	$\Delta_f H / \text{kJ mol}^{-1}$
C - H	400 - 415
N - H	390
O - H	460-464
C - C	345
C - N	290 -315
C-O	355 - 380
C - Cl	330
C - Br	275
O - O	175 - 184
C = C	610 - 630
C \equiv C	835
C = O	724 - 757
C \equiv N	854

5.6.3 Bond length : Bond length implies the equilibrium distance between the nuclei of two covalently bonded atoms in a molecule. Bond lengths are measured by X-ray and Electron diffraction techniques.

Table 5.7 Average bond lengths for some single, double and triple bonds

Type of bond	Covalent bond length (pm)	Type of bond	Covalent bond length (pm)
O-H	96	H_2 (H-H)	74
C-H	107	F_2 (F-F)	144
N-O	136	Cl_2 (Cl-Cl)	199
C-O	143	Br_2 (Br-Br)	228
C-N	143	I_2 (I-I)	267
C-C	154	N_2 (N \equiv N)	109
C = O	121	O_2 (O=O)	121
N = O	122	HF (H-F)	92
C = C	133	HCl (H-Cl)	127
C = N	138	HBr (H -Br)	141
C \equiv N	116	HI (H-I)	160
C \equiv C	120		

Each atom of the bonded pair contributes to the bond length. Bond length depends upon the size of atoms and multiplicity of bonds.

It increases with increase in size of atom and decreases with increase in multiplicity of bond. It is generally measured in picometre (pm) or in Angstrom unit (\AA) $-\text{> } = > \equiv >$, so C - C single bond is longer and C \equiv C triple bond is shorter.

Some typical average bond lengths of C - C single double and triple bond and others are shown in table 5.4.

5.6.4 Bond Order : According to the Lewis theory the bond order is equal to the number of bonds between the two atoms in a molecule. The bond order in H_2 , O_2 and N_2 is 1, 2 and 3 respectively. Isoelectronic molecules and ions have identical bond order. For example N_2 , CO and NO^+ each have bond order 3. F_2 whereas O_2^{2-} has bond order 1. Stabilities of molecules can be determined by knowing the bond order. As bond order increases, bond enthalpy increases and bond length decreases.

5.6.5 Polarity of a Covalent Bond : Covalent bonds are formed between two atoms of the same or different elements. Thus covalent bond is formed between atoms of some elements of H-H, F-F, Cl-Cl etc. The shared pair of electrons is attracted equally to both atoms and is situated midway between two atoms. Such covalent bond is termed as Nonpolar Covalent bond.

H : H H-H
electron pair at the centre Non polar
covalent bond

When a covalent bond is formed between two atoms of different elements and have different electronegativities the shared electron pair does not remain at the centre. The electron pair is pulled towards the more electronegative atom resulting in the separation of charges. This give rise to as Dipole. The more electronegative atom acquires a partial -ve charge and the other atom gets a partial +ve charge. Such a bond is called as **polar covalent bond**. The examples of polar molecules include. HF, HCl etc.

H : F $\delta^+H-F^{\delta-}$ H-F
Polar covalent bond

Fluorine is more electronegative than Hydrogen therefore the shared electron pair is more towards fluorine and the atoms acquire partial +ve and -ve charges, respectively. Polarity of the covalent bond increases as the difference in the electronegativity between the bonded atoms increases. When the difference in electronegativities of combining atom is about 1.7 ionic percentage in the covalent bond is 50%.



Can you tell?

Which molecules are polar ?
H-I, H-O-H, H-Br, Br₂, N₂, I₂, NH₃

5.7 Dipole moment

Definition : Dipole moment (μ) is the product of the magnitude of charge and distance between the centres of +ve and -ve charges.

$$\mu = Q \times r$$

Q : charge ; r : distance of separation.

unit of dipole moment is Debye (D)

$$1 \text{ D} = 3.33564 \times 10^{-30} \text{ Cm}$$

C : coulomb ; m : meter

Dipole moment being a vector quantity is represented by a small arrow with the tail on the positive centre and head pointing towards the negative centre.

$\delta^+H \rightleftharpoons F^{\delta-}$ ($\mu = 1.91 \text{ D}$). The crossed arrow (\longleftrightarrow) above the Lewis structural indicates the direction of the shift of electron density towards the more electronegative atom.

Dipole moments of polyatomic molecules

: Each polar bond in a polyatomic molecule has its own dipole. The resultant dipole of the molecule is decided by (i) shape of the molecule that is the spatial arrangement of bonds (ii) contribution of the individual dipoles and those of the lone pair of electrons, if any. The dipole moment of polyatomic molecule is the vector sum of the dipole moments of various bonds and lone pairs.

Consider BeF₂ and BF₃.

BeF₂ is a linear molecule and the dipoles are in opposite direction and are of equal strengths, so net dipole moment of BeF₂ = 0

F \longleftrightarrow Be \longleftrightarrow F $\longleftarrow + + \longrightarrow = 0$
Bond dipoles net dipole in BeF₂ = 0

BF₃ is angular

In BF₃ bond angle is 120° and molecule is symmetrical. The three B-F bonds are oriented at 120° with each other and sum of any two is equal and opposite to the third therefore sum of three B-F dipoles = 0.

F F
 \longleftrightarrow B \longleftrightarrow B \longleftrightarrow B $\longleftarrow + + \longrightarrow = 0$
Bond dipoles net dipole in BF₃ = 0

In case of angular molecules both lone pairs and electronegativity difference contribute to dipole moment.

Lone pairs and dipole moment : In some molecules the central atom has unshared or lone pairs of electrons. These lone pairs also contribute to overall dipole of the molecule. Nitrogen in NH₃ and Oxygen in H₂O posses

lone pairs, these reinforce the dipoles due to N-H and O-H bonds. Both these molecules are highly polar.

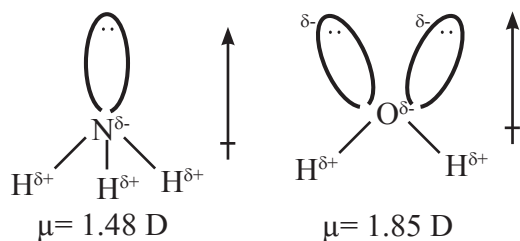

Nitrogen has only one lone pair while oxygen has two lone pairs which reflects in the higher dipole moment of water.

Consider NH_3 and NF_3

Both have pyramidal shape with a lone pair of electrons on nitrogen atom. Here hydrogen is less electronegative while, fluorine is more electronegative than nitrogen. The resultant dipole moment of NH_3 is $4.90 \times 10^{-30} \text{ Cm}$ while that of NF_3 is $0.80 \times 10^{-30} \text{ Cm}$. This difference is because in case of NH_3 the orbital dipole due to lone pair is in the same direction as that of resultant dipole moment of N-H bonds hence gets added whereas in NF_3 , the orbital moment is in the direction opposite to the resultant dipole moment of three N-F bonds. The orbital dipole because of lone pair decreases the effect of the resultant N-F bond moments, which results in its low dipole moment.

Resultant dipole moment

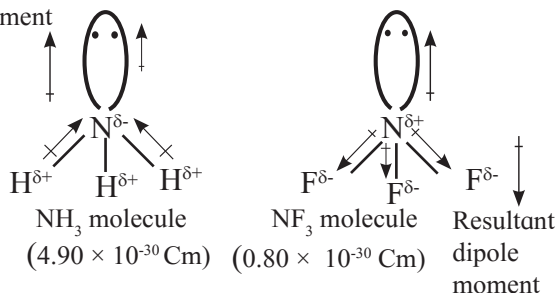

CH_4 : The central atom carbon has no lone pair and the molecule is non-polar.

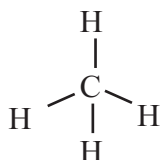

In CHCl_3 the dipoles are not equal and do not cancel hence CHCl_3 is polar with a non zero dipole moment.

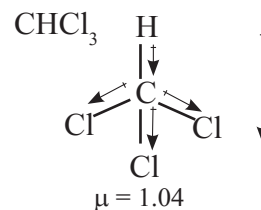

Dipole moments of some molecules are shown in table 5.8.

Table 5.8 dipole moments and geometry of some molecules

Types of molecule	Example	Dipole moment μ (D)	Geometry
Molecule AB	HF	1.91	linear
	HCl	1.03	linear
	HBr	0.79	linear
Molecule AB_2	H_2	0	linear
	H_2O	1.85	bent
	H_2S	0.95	bent
Molecule AB_3	CO_2	0	linear
	NH_3	1.47	trigonal pyramidal
	NF_3	0.23	trigonal pyramidal
Molecule AB_4	BF_3	0	trigonal planar
	CH_4	0	tetrahedral
	CHCl_3	1.04	tetrahedral
	CCl_4	0	tetrahedral

5.8.7 Covalent character of ionic bond :

Several ionic compounds possess partial covalent character and show properties similar to covalent compounds. For example LiCl is ionic but it is more soluble in organic solvents than water. To explain the partial covalent character in ionic bonds Fajans put forth the following rules :

1. The smaller size of the cation and larger the size of the anion renders, greater covalent character to ionic bond. For example $\text{Li}^{\oplus}\text{Cl}^{\ominus}$ is more covalent than $\text{Na}^{\oplus}\text{Cl}^{\ominus}$. Similarly $\text{Li}^{\oplus}\text{I}^{\ominus}$ is more covalent than $\text{Li}^{\oplus}\text{Cl}^{\ominus}$.
2. Greater the charge on cation, more is covalent character of the ionic bond. For example, covalent character of AlCl_3 , MgCl_2 and NaCl decreases in the following order $\text{Al}^{3\oplus}(\text{Cl}^{\ominus})_3 > \text{Mg}^{2\oplus}(\text{Cl}^{\ominus})_2 > \text{Na}^{\oplus}\text{Cl}^{\ominus}$
3. A cation with the outer electronic configuration of the $s^2p^6d^{10}$ type possess a greater polarising power compared to the cation having the same size and same charge but having outer electronic configuration of s^2p^6 type.

This is because d- electrons of the $s^2p^6d^{10}$ shell screen nuclear charge less effectively compared to s and p electrons of s^2p^6 shell. Hence the effective nuclear charge in a cation having $s^2p^6d^{10}$ configuration is greater than that of the one having s^2p^6 configuration. For example : $\text{Cu}^{\oplus}\text{Cl}^{\ominus}$ is more covalent than $\text{Na}^{\oplus}\text{Cl}^{\ominus}$. Here ($\text{Cu}^{\oplus} 1s^2 2s^2 2p^6 3s^2 3p^6 3d^{10}$; $\text{Na}^{\oplus} 1s^2 2s^2 2p^6$)

5.8 Resonance : Many polyatomic molecules can be represented by more than one Lewis structures. Consider for example, three structures written for $\text{CO}_3^{2\ominus}$. Each structure differs from the other only in the position of electrons without changing positions of the atoms.

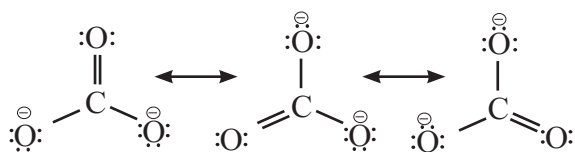

None of these individual structures is adequate to explain the properties. The actual structure of $\text{CO}_3^{2\ominus}$ is a combination of three Lewis structures and is called as the **resonance hybrid**. Resonance signifies that there is more than one possible way in which the electrons can be assigned in a Lewis structure. The various structures are called canonical forms.

Now consider the example of O_3 . It is the resonance hybrid of the following structures.

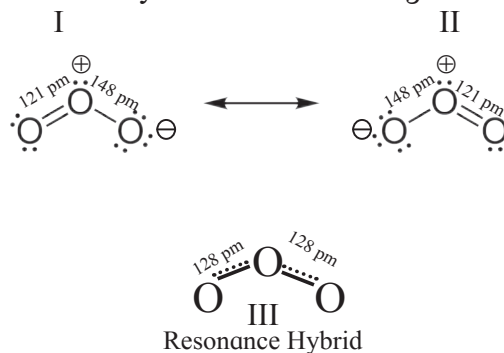

Fig. 5.13 Resonance in the O_3 molecule (structure I and II are canonical forms while structure III is the resonance hybrid.)

Resonance Energy :

We have seen that many polyatomic ions and molecules can be represented by different canonical forms and each form has a different energy. Energy of the resonating forms is different from the most stable structure, **resonance hybrid**. The difference in energy of the stable contributing structure and the resonating forms is usually defined as Resonance energy.

To summarize it can be stated that

- a. Energy of the resonance hybrid structure is less than the energy of any single canonical form hence, resonance stabilizes certain polyatomic molecules or ions.
- b. The average of all resonating structures contributes to overall bonding characteristic features of the molecule.

This will be clear from the example of ozone. Ozone can be represented by two canonical forms (shown earlier) I and II. III is the resonance hybrid. The energy of III is less than that of I and II.



Exercises

1. Select and write the most appropriate alternatives from the given choices.

- A. Which molecule is linear?
 a. SO_3 b. CO_2
 c. H_2S d. Cl_2O
- B. When the following bond types are listed in decreasing order of strength (strongest first). Which is the correct order ?
 a. covalent > hydrogen > vander waals'
 b. covalent > vander waal's > hydrogen
 c. hydrogen > covalent > vander waal's
 d. vander waal's > hydrogen > covalent.
- C. Valence Shell Electron Pair repulsion (VSEPR) theory is used to predict which of the following :
 a. Energy levels in an atom
 b. the shapes of molecules and ions.
 c. the electrone getivities of elements.
 d. the type of bonding in compounds.
- D. Which of the following is true for CO_2 ?

	C=O bond	CO_2 molecule
A	polar	non-polar
B	non-polar	polar
C	polar	polar
D	non-polar	non-polar

- E. Which O_2 molecule is paramagnetic. It is explained on the basis of :
 a. Hybridisation b. VBT
 c. MOT d. VSEPR
- F. The angle between two covalent bonds is minimum in:
 a. CH_4 b. C_2H_2
 c. NH_3 d. H_2O

2. Draw

- A. Lewis dot diagrams for the following
 a. Hydrogen (H_2)
 b. Water (H_2O)
 c. Carbon dioxide (CO_2)
 d. Methane (CH_4)
 e. Lithium Fluoride (LiF)
- B. Diagram for bonding in ethene with sp^2 Hybridisation.
- C. Lewis electron dot structures of
 a. HF b. C_2H_6 c. C_2H_4
 d. CF_3Cl e. SO_2
- D. Draw orbital diagrams of
 a. Fluorine molecule
 b. Hydrogen fluoride molecule

3. Answer the following questions

- A. Distinguish between sigma and pi bond.
- B. Display electron distribution around the oxygen atom in water molecule and state shape of the molecule, also write H-O-H bond angle.
- C. State octet rule. Explain its inadequacies with respect to
 a. Incomplete octet b. Expanded octet
- D. Explain in brief with one example:
 a. Ionic bond b. covalent bond
 c. coordinate bond
- E. Give reasons for need of Hybridisation
- F. Explain geometry of methane molecule on the basis of Hybridisation.
- G. In Ammonia molecule the bond angle is 107° and in water molecule it is $104^\circ 35'$, although in both the central atoms are sp^3 hybridized Explain
- H. Give reasons for:
 a. Sigma (σ) bond is stronger than Pi (π) bond.
 b. HF is a polar molecule
 c. Carbon is a tetravalent in nature.
- I. Which type of hybridization is present in ammonia molecule? Write the geometry and bond angle present in ammonia.
- J. Identify the type of overlap present in
 a. H_2 b. F_2 c. H-F molecule.
 Explain diagrammatically.
- K. F-Be-F is a linear molecule but H-O-H is angular. Explain.
- L. BF_3 molecule is planar but NH_3 pyramidal. Explain.
- M. In case of bond formation in Acetylene molecule :
 a. How many covalent bonds are formed ?
 b. State number of sigma and pi bonds formed.
 c. Name the type of Hybridisation.
- N. Define :
 a. Bond Enthalpy
 b. Bond Length
- O. Predict the shape and bond angles in the following molecules:
 a. CF_4 b. NF_3
 c. HCN d. H_2S

4. Using data from the Table, answer the following :

Examoles	C ₂ H ₆ Ethane	C ₂ H ₄ Ethene	C ₂ H ₂ Ethyne
Structure	$\begin{array}{c} \diagdown \\ \text{C} - \text{C} \\ \diagup \end{array}$	$\begin{array}{c} \diagdown \\ \text{C} = \text{C} \\ \diagup \end{array}$	$\text{-C} \equiv \text{C} \text{-}$
Type of bond between carbons	single	double	triple
Bond length (nm)	0.154	0.134	0.120
Bond Enthalpy kJ mol ⁻¹	348	612	837

- What happens to the bond length when unsaturation increases?
- Which is the most stable compound?
- Indicate the relation between bond strength and Bond enthalpy.
- Comment on overall relation between Bond length, Bond Enthalpy and Bond strength and stability.

5. Complete the flow chart

Molecular Formula	Structural Formula	Shape/Geometry	Bond angle
BeCl ₂	<input type="text"/>	<input type="text"/>	180°
<input type="text"/>	O=C=O	Linear	<input type="text"/>
C ₂ H ₂	<input type="text"/>	<input type="text"/>	<input type="text"/>

7. Answer in one sentence:

- Indicate the factor on which stability of ionic compound is measured?
- Arrange the following compounds on the basis of lattice energies in decreasing (descending) order: BeF₂, AlCl₃, LiCl, CaCl₂, NaCl
- Give the total number of electrons around sulphur (S) in SF₆ compound.
- Covalent bond is directional in nature. Justify.
- What are the interacting forces present during formation of a molecule of a compound ?
- Give the type of overlap by which pi (π) bond is formed.
- Mention the steps involved in Hybridization.
- Write the formula to calculate bond order of molecule.
- Why is O₂ molecule paramagnetic?
- What do you mean by formal charge ? Explain its significance with the help of suitable example.



Activity :

Practice the bonding structure with the help of structure set of chemistry.

6. Complete the following Table

Molecule	Type of Hybridisation	Type of bonds	Geometry	Bond angle
CH ₄	-	4C-H 4σ bonds	Tetrahedral	-
NH ₃	sp ³	3N-H 3σ bonds 1 lone pair	-	-
H ₂ O	-	-	angular	104.5°
BF ₃	sp ²	-	-	120°
C ₂ H ₄	-	-	-	120°
BeF ₂	-	2 Be-F	Linear	-
C ₂ H ₂	sp	(3σ+2π) 1C-C σ 2C-H σ 2C-C π	-	-

6. Redox Reactions

6.1 Introduction



Can you tell?

1. Why does cut apple turn brown when exposed to air ?
2. Why does old car bumper change colour?
3. Why do new batteries become useless after some days ?

Redox is an abbreviation used for the terms 'oxidation and reduction'. A large number of phenomena such as respiration, rusting, combustion of fuel involve redox reactions.



Can you recall?

1. What is combustion reaction?
2. Write an equation for combustion of methane.
3. What is the driving force behind reactions of elements?

6.1.1 Classical ideas of redox reactions

Classically oxidation refers to combination of an element or a substance with oxygen.

For example, Oxidation of carbon



Oxidation of magnesium



In reaction (6.1) and (6.2) the carbon and magnesium are oxidized on reacting with oxygen. Now consider the reaction :

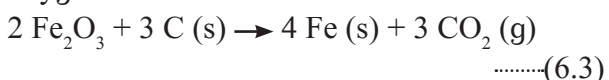

In this reaction there is removal of oxygen from Fe_2O_3 . Hence it is a **reduction reaction**.

Further

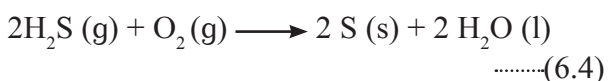

In this reaction there is removal of hydrogen and is also called **oxidation**. Here the sulfur in H_2S loses hydrogen and undergoes oxidation while oxygen accepts hydrogen and undergoes reduction.

Oxidants/ Oxidising agent : A reagent/ substance which itself undergoes reduction and causes oxidation of another species is called **oxidant /oxidising agent**. Now consider some more examples.



The above reactions are also examples of oxidation though no oxygen is involved and thus scope of oxidation can be expanded. Combination with electronegative element is oxidation. Oxidation can also be looked upon as the **removal of electropositive element**.

For example



Now let us consider some examples of **reduction**.

a. Removal of oxygen from mercuric oxide

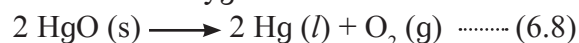

b. Removal of electronegative element from FeCl_3 as in

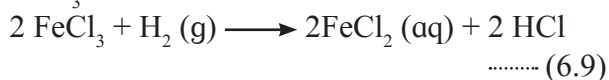

c. Addition of hydrogen

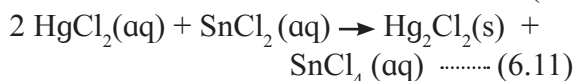
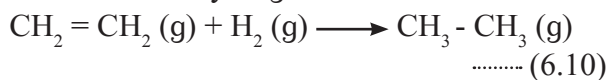

In eq. (6.8) there is removal of oxygen from mercuric oxide Eq (6.9) shows removal of electronegative element from FeCl_3 Eq (6.10) involves addition of hydrogen. Equation (6.11) involves addition of an electropositive element Hg to HgCl_2 . All these reactions represent **reduction**.

Reductant / reducing agent : A reagent / reducing agent is defined as a substance/ reagent which itself undergoes oxidation bringing about the reduction of another species. Now consider again equation (6.11). The equation (6.11) involves simultaneous oxidation and reduction. In this reaction HgCl_2 is reduced to Hg_2Cl_2 and SnCl_2 is oxidized to SnCl_4 . Hence it is redox reaction.

Key points

Oxidation it is defined as:

- addition of oxygen.
- addition of electronegative element.
- removal of hydrogen.
- removal of electropositive element.
- loss of electrons by any species.

Reduction it is defined as:

- removal of oxygen.
- removal of electronegative element.
- addition of hydrogen.
- addition of electropositive element.
- gain of electrons by any species.

6.1.2 Redox reaction in terms of electron transfer : Redox reaction can be described as electron transfer as shown below.



Development of charges on the species produced suggest the reactions 6.12 and 6.13 can be written as :

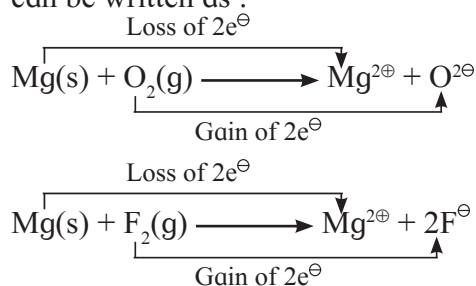

When Mg is oxidised to MgO, the neutral Mg atom loses electrons to form $\text{Mg}^{2\oplus}$ in MgO. The elemental oxygen gains electrons and forms $\text{O}^{2\ominus}$ in MgO.

Each of the above steps represents a half reaction which involves electron transfer (loss or gain). Sum of these two half reactions or the overall reaction is a redox reaction. Now consider the following half reactions.

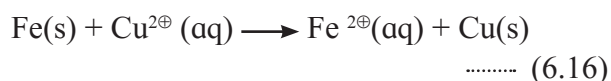
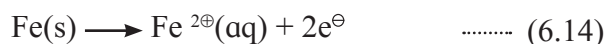

In the half reaction (6.14) Fe acts as a reducing agent whereas $\text{Cu}^{2\oplus}$ acts as oxidising agent which accepts electrons from Fe. The half reaction involving loss of electrons is called

oxidation reaction and that involving gain of electrons is called reduction. Thus eq. (6.14) is oxidation, eq. (6.15) is reduction and eq. (6.16) is a redox reaction.

Key points : Oxidant / oxidizing agent : A reagent / substance which itself undergoes reduction and causes oxidation of another species is called oxidant or oxidizing agent. This is an **electron acceptor**.

Reductant / Reducing agent : A reagent / reducing agent is defined as a substance / reagent which itself undergoes oxidation and brings about reduction of another species. A reductant is electron donor.

Displacement reactions can also be looked upon as redox reactions. In such reactions an ion (or atom) in a compound is replaced by an ion (or on atom) of another element.



The reaction (6.16) is displacement reaction.



Try this

Complete the following table of displacement reactions. Identify oxidising and reducing agents involved.

Reactants	Products
Zn (s) + (aq) (aq) + Cu (s)
Cu (s) + 2 Ag ⁺ (aq) +
..... +	Co ²⁺ (aq) + Ni (s)

6.2 Oxidation number : Description of redox reaction in terms of electron transfer suggest involvement of only ionic species in it. But many reactions involving only covalent bonds also fulfil the classical definition of oxidation and reduction. For example:



Eq (6.17) represents oxidation of H_2 as it is combination with oxygen. An electronegative element Cl is added to H_2 , and therefore, eq (6.18) also represents oxidation of H_2 . As products of both these oxidations are polar covalent molecules, there is an electron shift rather than complete electron transfer from one species to the other.

A practical method based on **oxidation number** is developed to describe all the redox reactions, which are either ionic involving complete electron transfer or covalent which refer to shift of electrons. In this method the electron pair in a covalent bond is assumed to belong to more electronegative element, that is, it shifts completely to more electronegative element.

Oxidation number of an element in a compound is **defined** as the number of electrical charges it carries (assuming complete electron transfer in the case of covalent bond). The following rules have been formulated to determine the oxidation number of an element in a compound.

6.2.1 Rules to assign oxidation number

1. The **oxidation number** of each atom of an **element** in free state is zero. Thus : Each atom in H_2 , Cl_2 , O_3 , S_8 , P_4 , O_2 , Ca, etc. has oxidation number of zero.
2. The **oxidation number** of an atom in a **monoatomic** ion is equal to its charge. Thus alkali metals have oxidation number +1 in all their compounds ($NaCl$, KCl , etc.). Alkaline earth metals have oxidation number +2 in all their compounds ($CaCO_3$, $MgCl_2$, etc.). Al is considered to have +3 as its oxidation number in all its compounds.
3. The **oxidation number of O** is usually -2 in all of its compounds except in peroxide or peroxide ion where it has oxidation number of -1 and in superoxide each oxygen has oxidation number -1/2.

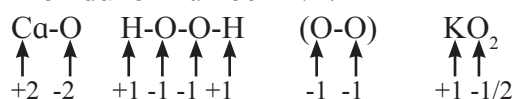

In OF_2 oxidation number of oxygen is +2.

4. The **oxidation number of H** atom is either +1 or -1. When the H atom is bonded to nonmetals, its oxidation number is +1. When it is bonded to metals, it possesses oxidation number of -1.

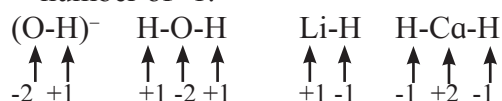

5. The oxidation number of F is -1 in all of its compounds. The other halogens Cl, Br and I usually exhibit oxidation number of -1 in their halide compounds. However in compounds in which halogens Cl, Br and I are bonded to oxygen, oxidation number of halogens is +1 For example,

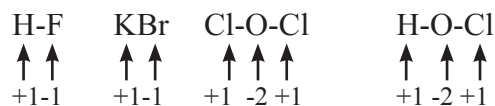

6. The algebraic sum of oxidation numbers of all the atoms in a neutral molecule is zero.
7. The algebraic sum of oxidation numbers of all the atoms in a polyatomic ion is equal to net charge of the ion.
8. When two or more atoms of an element are present in molecule or ion, oxidation number of the atom of that element will be average oxidation number of all the atoms of that element in that molecules.

By applying rules 1 to 5 it is possible to determine oxidation number(s) of atoms of various elements in molecules or ions. For doing this the rules 6, 7 and 8 are useful.

Problem 6.1: deduce the oxidation number of S in the following species:

- i. SO_2
- ii. $SO_4^{2\ominus}$

Solution:

- i. SO_2 is a neutral molecule :

\therefore Sum of oxidation number of all atom of $SO_2 = 0 = (\text{oxidation number of S}) + 2 \times (\text{oxidation number of O})$

$\therefore 0 = (\text{oxidation number of S}) + 2 \times (-2)$

\therefore Oxidation number of S in $SO_2 = 0 - (2 \times (-2)) = 0 - (-4) = +4$

- ii. $SO_4^{2\ominus}$ is an ionic species.

\therefore Sum of oxidation number of all atom of $SO_4^{2\ominus} = -2$

$= \text{Oxidation number of S} + 4 \times (\text{Oxidation number of O})$

\therefore Oxidation number of S in $SO_4^{2\ominus} = -2 - 4 \times (-2) = -2 + 8 = +6$



Remember

Oxidation number of an element can be positive or negative and a whole number or a fraction.

6.2.2 Stock notation : Oxidation number represents the oxidation state of an atom and is also denoted by Roman numeral in parentheses after the chemical symbol of the concerned element in the molecular formula. This representation is called **Stock notation** after the German Scientist Alfred Stock. For example :

- $\text{Au}^{1\oplus} \text{Cl}^{\ominus 1} \longrightarrow \text{Au(I)Cl}$
- $\text{Au}^{3\oplus} \text{Cl}_3^{\ominus 1} \longrightarrow \text{Au(III)Cl}_3$
- $\text{Sn}^{4\oplus} \text{Cl}_4^{\ominus 1} \longrightarrow \text{Sn(IV)Cl}_4$
- $\text{Sn}^{2\oplus} \text{Cl}_2^{\ominus 1} \longrightarrow \text{Sn(II)Cl}_2$
- $\text{Mn}^{4\oplus} \text{O}_2^{\ominus 2} \longrightarrow \text{Mn(IV)O}_2$

The Stock notation is used to specify the oxidation number of the metal. The idea of oxidation number is very convenient to define oxidation, reduction and the substances like oxidizing agent (oxidant) and reducing agent (reductant) of the redox reaction.

6.2.3 Redox reaction in terms of oxidation number :

Oxidation : An increase in the oxidation number of an element in a given substance.

Reduction : A decrease in the oxidation number of an element in a given substance.

Oxidizing agent : A substance which increases the oxidation number of an element in a given substance, and itself undergoes decrease in oxidation number of a constituent element.

Reducing agent : A substance that lowers the oxidation number of an element in a given substance, and itself undergoes an increase in the oxidation number of a constituent element in it.

Problem 6.2 : Assign oxidation number to each element in the following compounds or ions.

- a. KMnO_4 b. $\text{K}_2\text{Cr}_2\text{O}_7$ c. $\text{Ca}_3(\text{PO}_4)_2$

Solution :

a. KMnO_4

- Oxidation number of K = +1
 - Oxidation number of O = -2
 - Sum of the oxidation numbers of all atoms = 0
- \therefore Oxidation no. of K + oxidation of Mn + 4 x oxidation number of O = 0

$$\begin{aligned} (+1) + \text{oxidation number of Mn} + 4 \times (-2) &= 0 \\ \text{oxidation number of Mn} + 1 - 8 &= 0 \\ \text{oxidation number of Mn} - 7 &= 0 \\ \text{oxidation number of Mn} &= +7 \end{aligned}$$

b. $\text{K}_2\text{Cr}_2\text{O}_7$

- oxidation number of K = +1
 - oxidation number of O = -2
 - sum of oxidation number of all atoms = 0
- \therefore 2 x oxidation no. of K + 2x oxidation number of Cr + 7x oxidation number of O = 0
- \therefore 2 x (+1) + 2 x oxidation number of Cr + 7 x (-2) = 0
- \therefore +2 + 2 x oxidation number of Cr - 14 = 0
- \therefore 2x oxidation number of Cr + 2 - 14 = 0
- \therefore 2x oxidation number of Cr - 12 = 0
- \therefore 2x oxidation number of Cr = +12
- \therefore oxidation number of Cr = +12 / 2
- \therefore oxidation number of Cr = +6

c. $\text{Ca}_3(\text{PO}_4)_2$

- oxidation number of Ca = +2
(alkaline earth metal ion)
 - oxidation number of O = -2
 - sum of oxidation number of all atoms = 0
- \therefore 3 x O.N. of Ca + 2 x oxidation number of P + 8 x oxidation number of O = 0
- \therefore 3 x (+2) + 2 x oxidation number of P + 8 x (-2) = 0
- \therefore (+6) + 2 x oxidation number of P - 16 = 0
- \therefore 2 x oxidation number of P - 16 + 6 = 0
- \therefore 2 x oxidation number of P - 10 = 0
- \therefore 2 x oxidation number of P = +10
- \therefore oxidation number of P = +10/2
- \therefore oxidation number of P = + 5

Problem 6.3 : Assign oxidation number to the atoms other than O and H in the following species.

- i. $\text{SO}_3^{2\ominus}$ ii. BrO_3^{\ominus} iii. ClO_4^{\ominus} iv. NH_4^{\oplus} v. NO_3^{\ominus}
vi. NO_2^{\ominus} vii. SO_3 viii. N_2O_5

Solution : The oxidation number of O atom bonded to a more electropositive atom is -2 and that of H atom bonded to electronegative atom is +1. Using these values the oxidation numbers of atoms of the other elements in a given polyatomic species are calculated.



- 2 = oxidation number of S
 + 3 x (oxidation number of O)
 \therefore Oxidation number of S = - 2 - 3 (-2)
 = - 2 + 6 = 4



- 1 = oxidation number of Br
 + 3 x (oxidation number of O)
 \therefore Oxidation number of Br = - 1 - 3 (-2)
 = - 1 + 6 = 5

Similarly the oxidation number in the remaining species are found to be

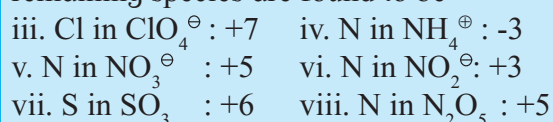

Problem 6.4 : Identify whether the following reactions are redox or not. State oxidants and reductants therein.

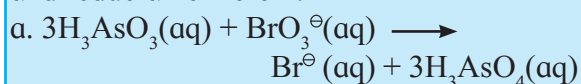

1. Write oxidation number of all the atoms of reactants and products

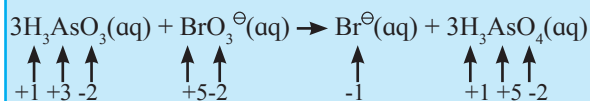

2. Identify the species that undergoes change in oxidation number

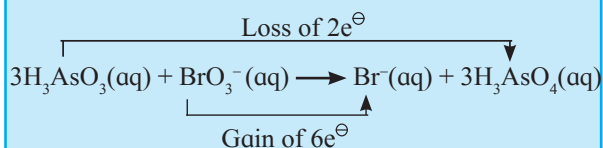

The oxidation number of As increases from +3 to +5 and that of Br decreases from +5 to -1. Because oxidation number of one species increases and that of other decreases, the reaction is therefore redox reaction.

The oxidation number of As increases by loss of electron. Thus As is a reducing agent and it itself is oxidized. On the other hand, the oxidation number of Br decreases. Hence, it is reduced by the gain of electron and act as an oxidizing agent.

Result :

1. The reaction is redox reaction.
2. Oxidant/oxidizing agent - BrO_3^{\ominus}
3. Reductant/Reducing agent - H_3AsO_3



Do you know ?

Some elements in a particular compound may possess fractional oxidation number. For example : C_3O_2 , Br_3O_8 , $\text{Na}_2\text{S}_4\text{O}_6$, C_8H_{18} , etc. In these compounds oxidation number of C, Br, S, C are 4/3, 16/3, 2.5, 9/4, respectively. These oxidation numbers are actually the average oxidation number of all the atoms of elements in that compound. Different atoms of the element in such species exhibit different oxidation states. For example : Tetra thionate ion has two S atoms with oxidation number +5 and two with zero (0). Therefore, the average oxidation number of S in these species is $10/4 = 2.5$

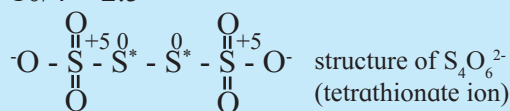

6.3 Balancing of redox reactions : Two methods are used to balance chemical equation for redox processes : Oxidation number method and Half reaction method or Ion electron method.

6.3.1 The Oxidation number method is illustrated in the following steps :

Step I : Write the unbalanced equation for redox reaction. Balance the equation for all atoms in the reactions, except H and O. Identify the atoms which undergo change in oxidation number and by how much. Draw the bracket to connect atoms of the elements that changes the oxidation number.

Step II : Show an increase in oxidation number per atom of the oxidised species and hence the net increase in oxidation number. Similarly show a decrease in the oxidation number per atom of the reduced species and the net decrease in oxidation number. Determine the factors which will make the total increase and decrease equal. Insert the coefficients into the equation.

Step III : Balance oxygen atoms by adding H_2O to the side containing less O atoms, One H_2O is added for one O atom. Balance H atoms by adding H^{\oplus} ions to the side having less H atoms.

Step IV : If the reaction occurs in basic medium, then add OH^\ominus ions, equal to the number of H^\oplus ions added in step III, on both the sides of equation. The H^\oplus and OH^\ominus on same sides of reactions are combined to give H_2O molecules.

Step V : Check the equation with respect to both, the number of atoms of each element and the charges. It is balanced.

Note : For acidic medium step IV is omitted.

Problem 6.5 : Using the oxidation number method write the net ionic equation for the reaction of potassium permanganate, KMnO_4 , with ferrous sulphate, FeSO_4 .

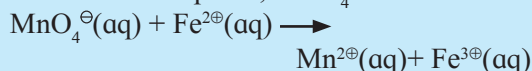

Solution :

Step 1 : The skeletal ionic equation is

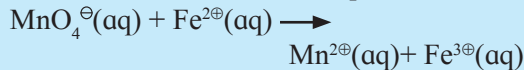

Step 2 : Assign oxidation number to Mn and Fe, and calculate the increase and decrease in the oxidation number and make them equal .

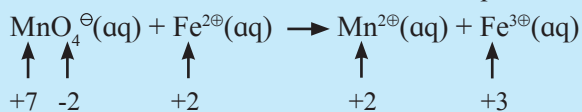

increase in oxidation number :



increase per atom = 1

decrease in oxidation number



decrease per atom = 5

to make the net increase and decrease equal we must take 5 atoms of $\text{Fe}^{2\oplus}$

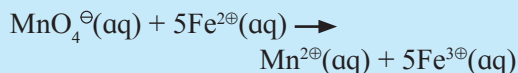

Step 3 : Balance the 'O' atoms by adding $4\text{H}_2\text{O}$ to the right hand side.

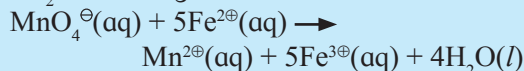

Step 4: The medium is acidic. To make the charges and hydrogen atoms on the two sides equal, add 8H^\oplus on the left hand side.

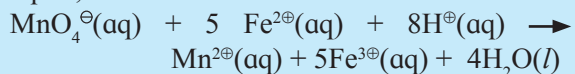

Step 5: Check the two sides for balance of charges and atoms. The net ionic equation obtained in step 4 is the balanced equation.

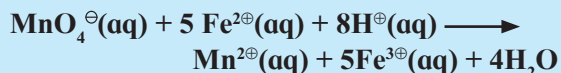

Problem 6.6 : Balance the following reaction by oxidation number method.



Solution :

Step I : Write skeletal equation and balance the elements other than O and H.

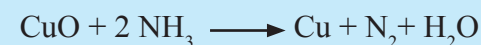

Step II : Assign oxidation number to Cu and N. Calculate the increase and decrease in the oxidation number and make them equal.

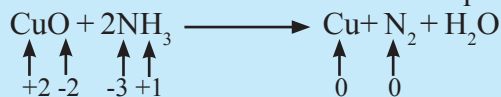

increase in oxidation number :

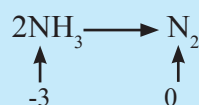

increase per atom = 3

decrease in oxidation number

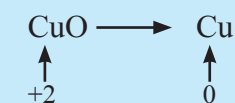

decrease per atom = 2

to make the net increase and decrease equal we must take 3 atoms of Cu and 2 atoms of N



Step III : Balance 'O' atoms by addition $2\text{H}_2\text{O}$ to the right hand side.



Step IV : Charges are already balanced

Step V : Check two sides for balanced of atoms and charges. The equation obtained in step IV is balanced.



6.3.2 Ion electron method (Half reaction method) :

In this method two half equations are balanced separately and then added together to give balanced equation. Following steps are involved

Step I : Write unbalanced equation for the redox reaction, Assign oxidation number to all the atoms in the reactants and products. Divide the equation into two half equations. One half equation involves increase in oxidation number and another involves decrease in oxidation

number (Write two half equation separately)

Step II : Balance the atoms except O and H in each half equation. Balance oxygen atom by adding H₂O to the side with less O atoms.

Step III : Balance the H⁺ atom by adding H⁺ ions to the side with less H⁺ atoms.

Step IV : Balance the charges by adding appropriate number of electrons to the right side of oxidation half equation and to the left of reduction half equation.

Step V : Multiply half equation by suitable factors to equalize the number of electrons in two half equations. Add two half equations and cancel the number of electrons on both sides of equation.

Step VI : If the reaction occurs in basic medium then add OH⁻ ions, equal to number of H⁺ ions on both sides of equation. The H⁺ and OH⁻ ions on same side of equation combine to give H₂O molecules.

Step VII : Check that the equation is balanced in both, the atoms and the charges.

Problem 6.7 : Balance the following unbalanced equation (in acidic medium) by ion electron (half reaction method)

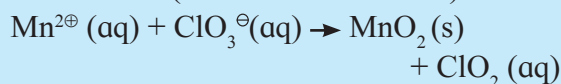

Solution :

Step I : Write unbalanced equation for the redox reaction. Assign oxidation number to all the atoms in reactants and product then. Divide the equation into two half equations.

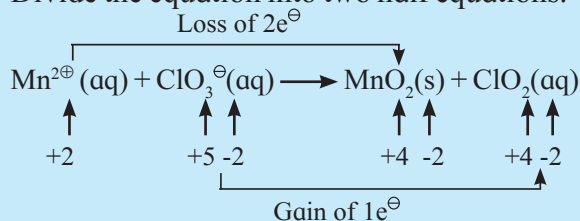

Oxidation half reaction



Reduction half reaction

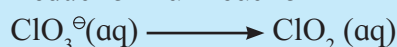

Step II : Balance half equations for O atoms by adding H₂O to the side with less O atoms. Add 2H₂O to left side of oxidation and one H₂O to the right side of reduction.

Oxidation

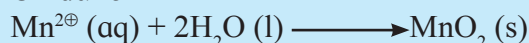

Reduction



Step III : Balance H⁺ atoms by adding H⁺ ions to the side with less H. Hence add 4H⁺ ions to the right side of oxidation and 2H⁺ ions to the left side of reduction.

Oxidation

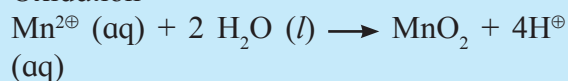

Reduction

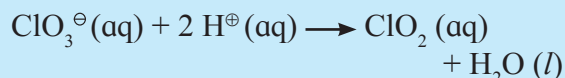

Step IV : Now add 2 electrons to the right side of oxidation and 1 electron to the left side of reduction to balance the charges.

Oxidation

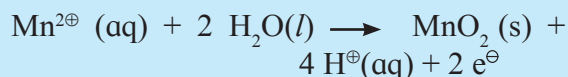

Reduction

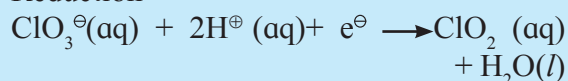

Step V : Multiply reduction half equation by 2 to equalize number of electrons in two half equations. Then add two half equation.

Oxidation

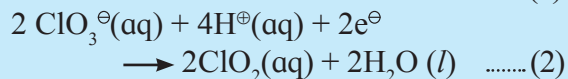
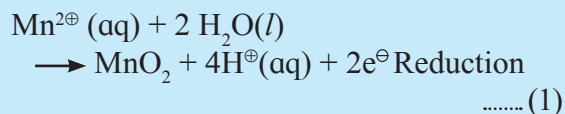

eq. (1) + eq. (2) gives the net reaction

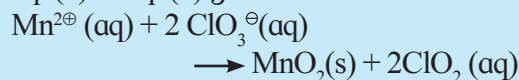

The equation is balanced in terms of number of atoms and the charges.

Problem 6.8 : Balance the following unbalanced equation by ion electron (half reaction method)

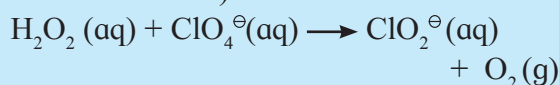

Solution :

Step I : Write unbalanced equation for the redox reaction and assign oxidation number to all the atoms in reactants and products. Divide the equation into two half equations.

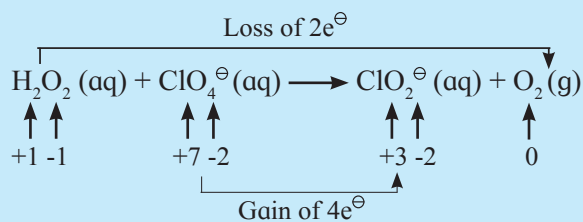

Oxidation



Reduction



Step II : Balance the half equation for O atoms by adding H₂O to the side with less O atoms. Hence add 2 H₂O to the right side of reduction half equation and none to the oxidation half equation

Oxidation



Reduction



Step III : Balance H atoms by adding H⁺ ions to the side with less H. Hence add 2H⁺ ions to the right side of oxidation half equation and 4H⁺ ions to the left side of reduction half equation.

Oxidation



Reduction

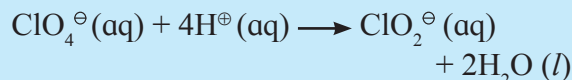

Step IV : Add 2 electrons to the right side of oxidation half equation and 4 electrons to the left side of reduction half equation to balance the charges.

Oxidation

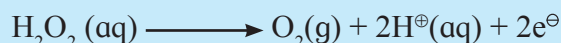

Reduction

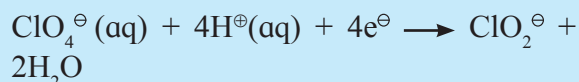

Step V : Multiply oxidation half equation by 2 to equalize the number of electrons and then add two half equations.

Oxidation



Reduction

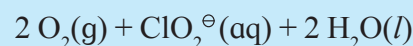
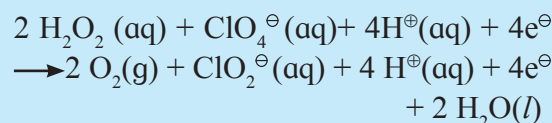
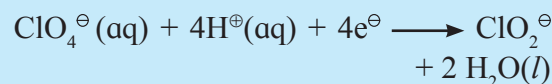

This equation is balanced in terms of atoms and charges.



Try this

Classify the following unbalanced half equations as oxidation and reduction

Example	Type
$\text{Cl}^-(\text{aq}) \longrightarrow \text{Cl}_2(\text{g})$	oxidation
$\text{OCl}^-(\text{aq}) \longrightarrow \text{Cl}^-(\text{g})$	
$\text{Fe}(\text{OH})_2 \longrightarrow \text{Fe}(\text{OH})_3$	
$\text{VO}^{2+}(\text{aq}) \longrightarrow \text{V}^{3+}(\text{aq})$	

6.4 Redox reaction and electrode potential

We noted in the section 6.1.1 that displacement reaction can be looked upon as redox reaction. Consider the following displacement reaction.

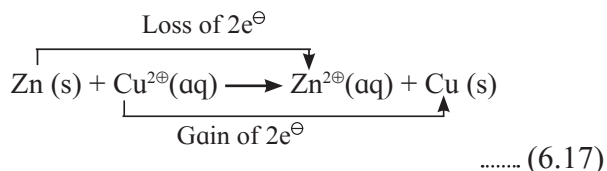

This reaction can be brought about in two ways. The simpler method to observe this reaction is to take copper sulfate solution in a container and dip zinc rod in it. The redox reaction (6.17) takes place in that container. Zinc gets oxidized to Zn²⁺ ion and Cu²⁺ ions get reduced to metallic Cu. A direct transfer of electron from zinc atom to cupric ions takes place in this case.

The electron transfer from Zn atom to Cu²⁺ ions can be demonstrated by carrying out two half reactions in two separate containers as shown in Fig. 6.1

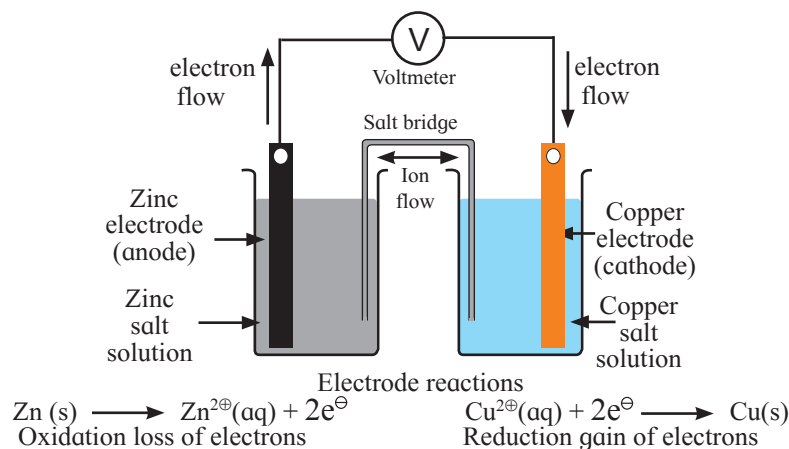

Fig. 6.1 : Daniel Cell

The set up in Fig. 6.1 is that of Daniel cell. The zinc and copper plates are connected by an electric wire through a switch and voltmeter. The solution in two containers are connected by salt bridge (U-shaped glass tube containing a gel of KCl or NH_4NO_3 in agar-agar). When switch is on, electrical circuit is complete as indicated by the deflection in the voltmeter. The circuit has two parts, one in the form of electrical wire which allows the flow of electrons and the other in the form of two solutions joined by salt bridge. In solution part of the circuit, the electric current is carried by movement of ions. When a circuit is complete, the zinc atoms on zinc plates spontaneously lose electrons which are picked up in the external circuit. The electrons flow from the zinc plate to copper plate through wire. $\text{Cu}^{2\oplus}$ ions in the second container receive these electrons through the copper plate and are reduced to copper atoms which get deposited on the copper plate. Here, zinc plate acts as anode (negative electrode) and the copper plate acts as cathode (positive electrode). Thus, when two half reactions, namely, oxidation and reduction, allowed to take place in separate container and provision is made for completing the electrical circuit, electron transfer take place through the circuit. This results in flow of electric current in the circuit as indicated by deflection in voltmeter. This is a simple electrochemical cell called Daniel cell, in which electricity is generated by redox reaction.

In an electrochemical cell electrons flow in the external circuit from anode to cathode while the conventional current flows from cathode to anode. An electrical potential is said to be established at the two electrodes of an electrochemical cell. It is called **electrode potential**. The magnitude and direction of the electrode potential depends upon the nature of the metal and ions, concentration of ions and temperature. The reaction associated with an electrode is called **electrode reaction**. The two chemical species are linked by transfer of electrons forms **redox couple**.

6.4.1 Standard electrode potential : When concentration of each species taking part in the electrode reaction is unity and the temperature is 298 K, observed electrode potential is called standard electrode potential (E^0). By convention the standard electrode potential of hydrogen electrode is 0.00 Volt. Standard hydrogen electrode is used as reference electrode for determination of E^0 values of various redox couples.

Significance of E^0 value : The electrode reaction considered for the electrode potential is reduction reaction. Therefore, value and sign of standard electrode potential is a measure of the tendency of active species in the electrode reaction to remain in the oxidized / reduced form. A negative E^0 means redox couple is a stronger reducing agent than the $\text{H}^{\oplus}/\text{H}_2$ couple. Table 6.1 shows standard electrode potentials of reduction process of some redox couples.

Large negative value of E^0 means that redox couple is stronger reducing agent. On the other hand, more positive value of E^0 means the redox couple is stronger oxidizing agent. From the table 6.1 it is seen that alkali metals have high negative value of E^0 , which means that they are strong reducing agent. The alkali metals have great tendency to give away electron and form cations. On the other hand, fluorine has highly positive value of E^0 and thus great tendency to gain electron and is therefore, very strong oxidizing agents.

Table 6.1 : standard electrode potentials of some redox couples

Oxidised form + $ne^\ominus \longrightarrow$ reduced form	E^0/V
$F_2(g) + 2e^\ominus \longrightarrow 2F^\ominus$	2.87
$H_2O_2 + 2H^\oplus + 2e^\ominus \longrightarrow 2H_2O$	1.78
$MnO_4^\ominus + 8H^\oplus + 5e^\ominus \longrightarrow Mn^{2\oplus} + 4H_2O$	1.51
$Cl_2(g) + 2e^\ominus \longrightarrow 2Cl^\ominus$	1.36
$Cr_2O_7^{2\ominus} + 14H^\oplus + 6e^\ominus \longrightarrow 2Cr^{3\oplus} + 7H_2O$	1.33
$O_2(g) + 4H^\oplus + 4e^\ominus \longrightarrow 2H_2O$	1.23
$Br_2 + 2e^\ominus \longrightarrow 2Br^\ominus$	1.09
$2Hg^{2\oplus} + 2e^\ominus \longrightarrow Hg_2^{2\oplus}$	0.92
$Fe^{3\oplus} + e^\ominus \longrightarrow Fe^{2\oplus}$	0.77
$I_2(s) + 2e^\ominus \longrightarrow 2I^\ominus$	0.54
$2H^\oplus + 2e^\ominus \longrightarrow H_2(g)$	0.00
$Zn^{2\oplus} + 2e^\ominus \longrightarrow Zn(s)$	-0.76
$Al^{3\oplus} + 3e^\ominus \longrightarrow Al(s)$	-1.66
$Mg^{2\oplus} + 2e^\ominus \longrightarrow Mg(s)$	-2.36
$Na^\oplus + e^\ominus \longrightarrow Na(s)$	-2.71
$Ca^{2\oplus} + 2e^\ominus \longrightarrow Ca(s)$	-2.87
$K^\oplus + e^\ominus \longrightarrow K(s)$	-2.93
$Li^\oplus + e^\ominus \longrightarrow Li(s)$	-3.05

We shall learn more about electrode potential and electrochemical cells in the 12th standard.

Problem 6.9 : By using standard electrode potential table predict the reaction between the following is spontaneous. a. $Fe^{3\oplus}(aq)$ and $I^\ominus(aq)$, b. $Ag^\oplus(aq)$ and $Cu(s)$

Solution : Write oxidation half reaction for one species and reduction half reaction for the other species. Change the sign of E^0 of oxidation half reaction. Take the sum of two E^0 values. If the sum is positive the reaction between two species is spontaneous.

a. $Fe^{3\oplus}(aq)$ and $I^\ominus(aq)$

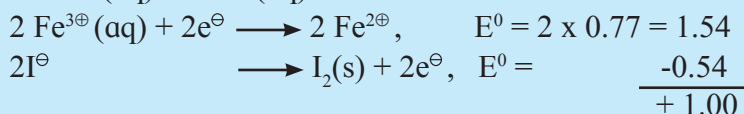

The sum of E^0 values is positive, therefore reaction is spontaneous.

b. $Ag^\oplus(aq)$ and $Cu(s)$

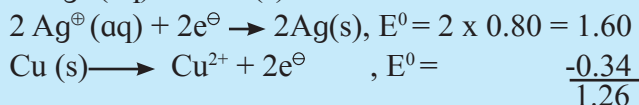

The sum of E^0 values is positive, therefore reaction is spontaneous.



Exercises

1. Choose the most correct option

- A. Oxidation numbers of Cl atoms marked as Cl^a and Cl^b in CaOCl₂ (bleaching powder) are

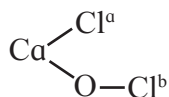

- a. zero in each
b. -1 in Cl^a and +1 in Cl^b
c. +1 in Cl^a and -1 in Cl^b
d. 1 in each
- B. Which of the following is not an example of redox reaction ?

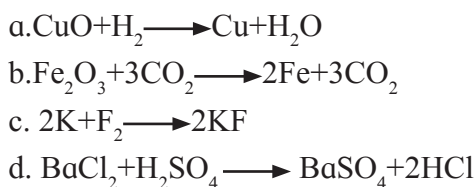

- C. A compound contains atoms of three elements A, B and C. If the oxidation state of A is +2, B is +5 and that of C is -2, the compound is possibly represented by

- a. A₂(BC₃)₂
b. A₃(BC₄)₂
c. A₃(B₄C)₂
d. ABC₂

- D. The coefficients p, q, r, s in the reaction
$$p \text{Cr}_2\text{O}_7^{2\ominus} + q \text{Fe}^{2\oplus} \longrightarrow r \text{Cr}^{3\oplus} + s \text{Fe}^{3\oplus} + \text{H}_2\text{O}$$

respectively are :

- a. 1, 2, 6, 6
b. 6, 1, 2, 4
c. 1, 6, 2, 6
d. 1, 2, 4, 6
- E. For the following redox reactions, find the correct statement.

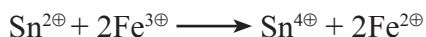

- a. Sn²⁺ is undergoing oxidation

- b. Fe³⁺ is undergoing oxidation

c. It is not a redox reaction

d. Both Sn²⁺ and Fe³⁺ are oxidised

- F. Oxidation number of carbon in H₂CO₃ is

a. +1 b. +2

c. +3 d. +4

- G. Which is the correct stock notation for manganese dioxide ?

a. Mn(I)O₂ b. Mn(II)O₂

c. Mn(III)O₂ d. Mn(IV)O₂

- I. Oxidation number of oxygen in superoxide is

a. -2 b. -1 c. $-\frac{1}{2}$ d. 0

- J. Which of the following halogens does always show oxidation state -1 ?

a. F

b. Cl

c. Br

d. I

- K. The process $\text{SO}_2 \longrightarrow \text{S}_2\text{Cl}_2$ is

a. Reduction

b. Oxidation

c. Neither oxidation nor reduction

d. Oxidation and reduction.

2. Write the formula for the following compounds :

A. Mercury(II) chloride

B. Thallium(I) sulphate

C. Tin(IV) oxide

D. Chromium(III) oxide

3. Answer the following questions

- A. In which chemical reaction does carbon exhibit variation of oxidation state from -4 to +4 ? Write balanced chemical reaction.

- B. In which reaction does nitrogen exhibit variation of oxidation state from -3 to +5 ?

C. Calculate the oxidation number of underlined atoms.

- a. $\text{H}_2\underline{\text{S}}\text{O}_4$ b. $\text{H}\underline{\text{N}}\text{O}_3$ c. $\text{H}_3\underline{\text{P}}\text{O}_3$
 d. $\text{K}_2\underline{\text{C}}_2\underline{\text{O}}_4$ e. $\text{H}_2\underline{\text{S}}_4\underline{\text{O}}_6$ f. $\underline{\text{C}}_2\underline{\text{O}}_7^{2-}$
 g. $\text{NaH}_2\underline{\text{P}}\text{O}_4$

D. Justify that the following reactions are redox reaction; identify the species oxidized/reduced, which acts as an oxidant and which act as a reductant.

- a. $2\text{Cu}_2\text{O}(\text{s}) + \text{Cu}_2\text{S}(\text{s}) \longrightarrow 6\text{Cu}(\text{s}) + \text{SO}_2(\text{g})$
 b. $\text{HF}(\text{aq}) + \text{OH}^\ominus(\text{aq}) \longrightarrow \text{H}_2\text{O}(\text{l}) + \text{F}^\ominus(\text{aq})$
 c. $\text{I}_2(\text{aq}) + 2 \text{S}_2\text{O}_3^{2\ominus}(\text{aq}) \longrightarrow \text{S}_4\text{O}_6^{2\ominus}(\text{aq}) + 2\text{I}^\ominus(\text{aq})$

E. What is oxidation? Which one of the following pairs of species is in its oxidized state ?

- a. $\text{Mg} / \text{Mg}^{2\oplus}$ b. $\text{Cu} / \text{Cu}^{2\oplus}$
 c. $\text{O}_2 / \text{O}^{2\ominus}$ d. $\text{Cl}_2 / \text{Cl}^\ominus$

F. Justify the following reaction as redox reaction.

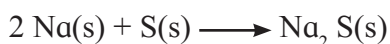

Find out the oxidizing and reducing agents.

G. Provide the stock notation for the following compounds : HAuCl_4 , Ti_2O , FeO , Fe_2O_3 , MnO and CuO .

H. Assign oxidation number to each atom in the following species.

- a. $\text{Cr}(\text{OH})_4^\ominus$ b. $\text{Na}_2\underline{\text{S}}_2\underline{\text{O}}_3$
 c. $\text{H}_3\underline{\text{B}}\text{O}_3$

I. Which of the following redox couple is stronger oxidizing agent ?

- a. Cl_2 ($E^0 = 1.36 \text{ V}$) and Br_2 ($E^0 = 1.09 \text{ V}$)
 b. MnO_4^\ominus ($E^0 = 1.51 \text{ V}$) and $\text{Cr}_2\text{O}_7^{2\ominus}$ ($E^0 = 1.33 \text{ V}$)

J. Which of the following redox couple is stronger reducing agent ?

- a. Li ($E^0 = - 3.05 \text{ V}$) and Mg ($E^0 = - 2.36 \text{ V}$)
 b. Zn ($E^0 = - 0.76 \text{ V}$) and Fe ($E^0 = - 0.44 \text{ V}$)

4. Balance the reactions/equations :

A. Balance the following reactions by oxidation number method

- a. $\text{Cr}_2\text{O}_2^{2\ominus}(\text{aq}) + \text{SO}_3^{2\ominus}(\text{aq}) \longrightarrow \text{Cr}^{3\oplus}(\text{aq}) + \text{SO}_4^{2\ominus}(\text{aq})$ (acidic)
 b. $\text{MnO}_4^\ominus(\text{aq}) + \text{Br}^\ominus(\text{aq}) \longrightarrow \text{MnO}_2(\text{s}) + 13 \text{CrO}_3^\ominus(\text{aq})$ (basic)
 c. $\text{H}_2\text{SO}_4(\text{aq}) + \text{C}(\text{s}) \longrightarrow \text{CO}_2(\text{g}) + \text{SO}_2(\text{g}) + \text{H}_2\text{O}(\text{l})$ (acidic)
 d. $\text{Bi}(\text{OH})_3(\text{g}) + \text{Sn}(\text{OH})_3^\ominus(\text{aq}) \longrightarrow \text{Bi}(\text{s}) + \text{Sn}(\text{OH})_6^{2\ominus}(\text{aq})$ (basic)

B. Balance the following redox equation by half reaction method

- a. $\text{H}_2\text{C}_2\text{O}_4(\text{aq}) + \text{MnO}_4^\ominus(\text{aq}) \longrightarrow \text{CO}_2(\text{g}) + \text{Mn}^{2\oplus}(\text{aq})$ (acidic)
 b. $\text{Bi}(\text{OH})_3(\text{s}) + \text{SnO}_2^{2\ominus}(\text{aq}) \longrightarrow \text{SnO}_3^{2\ominus}(\text{aq}) + \text{Bi}(\text{s})$ (basic)

5. Complete the following table :

Assign oxidation number to the underlined species and write Stock notation of compound

Compound	Oxidation number	Stock notation
$\underline{\text{A}}\text{uCl}_3$		
$\underline{\text{S}}\text{nCl}_2$		
$\underline{\text{V}}_2\underline{\text{O}}_7^{4-}$		
$\underline{\text{P}}\text{tCl}_6^{2-}$		
$\text{H}_3\underline{\text{A}}\underline{\text{s}}\text{O}_3$		



Activity :

Perform redox reaction experiment with the help of Daniel cell under teacher guidance.

7. Modern Periodic Table



Can you recall?

- What was the basis of classification of elements before the knowledge of electronic structure of atom?
- Name the scientists who made the classification of elements in the nineteenth century.
- What is Mendeleev's periodic law?
- How many elements are discovered upto now?
- How many horizontal rows and vertical columns are present in modern periodic table?

7.1 Introduction

In the early nineteenth century about 30 elements were known and were classified into three types on the basis of their physical properties as: **metals, nonmetals and metalloids**. Subsequent noteworthy attempts for classification of the increasing number of elements based on **atomic mass** were **Dobereiner's triads** and **Newlands' octaves**.



Just think

- How many days pass between two successive full moon nights?
- What type of motion does a pendulum exhibit?
- Give some other examples of periodic events.

In **1869**, **Russian chemist Dmitri Mendeleev** put forth periodic table of the 63 elements known at that time using the atomic mass and properties of elements. Mendeleev's periodic table was based on the **Mendeleev's periodic law** which is stated as "**The physical and chemical properties of elements are periodic function of their atomic masses**".

Mendeleev arranged the elements known at that time in an increasing order of their atomic masses. The serial or ordinal number of an element in the increasing order of atomic mass was referred to as its atomic number. He folded this list in accordance with recurrence of properties of elements and formed his periodic table consisting of vertical groups and horizontal series (now called periods).

In Mendeleev's periodic table, elements belonging to the same group showed similar properties. Properties of elements in a series/period showed gradual variation from left to right. Mendeleev left some gaps corresponding to certain atomic numbers in the periodic table so as to maintain the periodicity of the properties. Mendeleev's periodic table was accepted by the scientific community since the newly discovered elements fitted well into the gaps with their properties as predicted by Mendeleev's periodic law. Inert gases, not predicted by Mendeleev and discovered in later years also could be accommodated in this periodic table by creating an additional group.

After the discovery of atomic structure, the atomic number, which was an ordinal number assigned to element in Mendeleev's periodic table, was recognized as the proton number, Z , of that element. This was the outcome of **Henry Moseley's work (1913)** on x-ray spectroscopic study of a large number of elements. Moseley showed that the frequency of x-ray emitted by an element is related to atomic number, Z , rather than the atomic mass. The atomic number, Z , was considered as more fundamental property of the atom than the atomic mass. As a result, Mendeleev's periodic law was modified. It is called the **modern periodic law** and is stated as: "**The physical and chemical properties of elements are a periodic function of their atomic numbers**".

Mendeleev's periodic table was revised in accordance with the modern periodic law. We will look into the final revised version known as the **modern periodic table** also called the **long form of periodic table** in the following sections.

7.2 Structure of the Modern Periodic Table

Over a long period of time many scientists have come up with different forms of periodic table. However, the so called '**long form of periodic table**' or '**the modern periodic table**', which is a revised version of Mendeleev's periodic table, is the most convenient and widely used form of the periodic table of elements today.

The modern periodic table has horizontal rows intersecting the vertical columns giving rise to a number of boxes. The horizontal rows are called periods (which Mendeleev called series) and the vertical columns are called groups. There are **seven periods** (numbered 1 to 7) and **eighteen groups** (numbered 1 to 18) in the modern periodic table.

This numbering of the periods and groups is recommended by the **International Union of Pure and Applied Chemistry, IUPAC**. The boxes formed at the intersection of the periods and groups are the places for individual elements. Below the main table are placed **two series** containing fourteen elements each. There are in all 118 boxes to accommodate **118 elements** in the modern periodic table. As on today all the 118 boxes are filled as a result of discovery of manmade elements. IUPAC has approved names and symbols of all the 118 elements. (Refer to Fig. 7.1)

The overall shape of the modern periodic table shows that it is divided into four blocks. Two groups on left form the **s-block**, six groups on the right constitute the **p-block**, ten groups in the center form the **d-block** and the two series at the bottom constitute the **f-block** (Fig. 7.2).

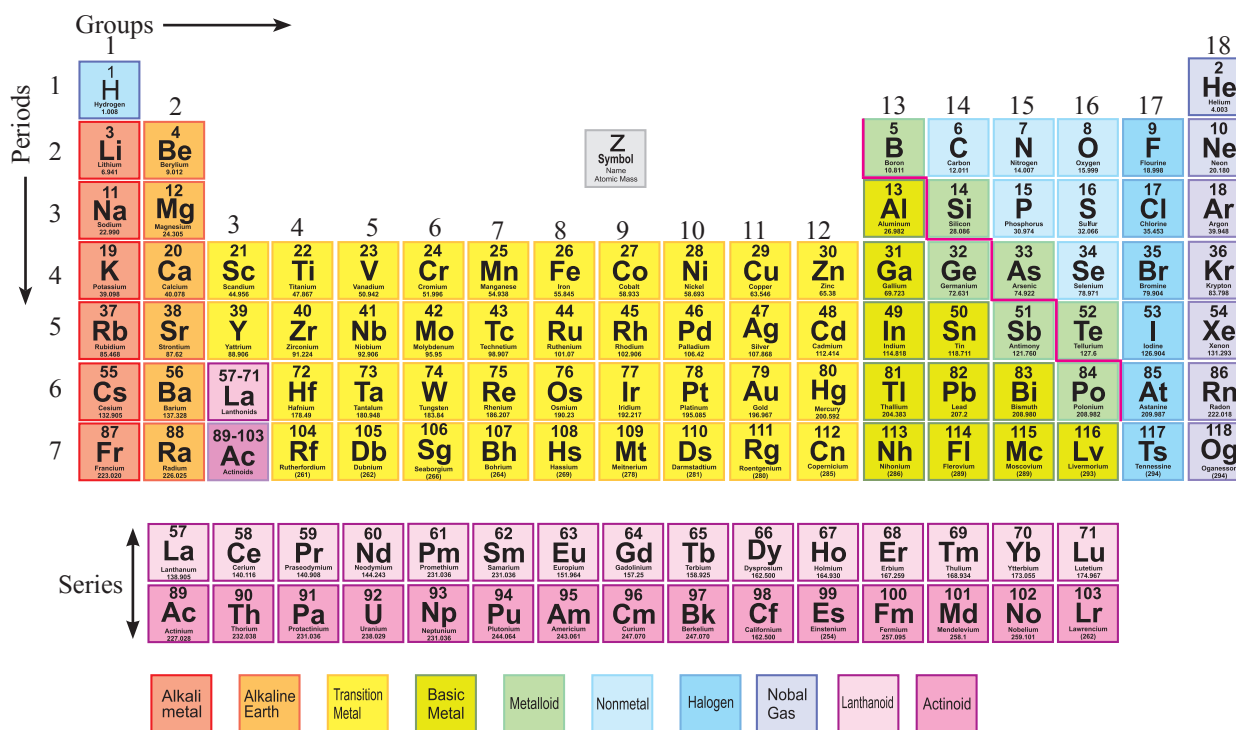

Fig. 7.1 : Modern Periodic Table

(Refer page 271)

7.3 Periodic Table and Electronic configuration



Can you recall?

- What does the principal quantum number ' n ' and azimuthal quantum number ' l ' of an electron belonging to an atom represent?
- Which principle is followed in the distribution of electrons in an atom?

When Mendeleev put forth his periodic table in 1869, the atomic structure was not known. He observed periodicity in the properties of elements on arranging them in an increasing order of atomic mass. Later, with the advent of quantum mechanical model of atom, the properties of elements were correlated to electronic configuration.

You have learnt in the Chapter 4 that the electrons in atom are distributed in shells and subshells in accordance with the **aufbau principle** which includes **increasing order of energy, Pauli exclusion principle and Hund's rule of maximum multiplicity**. When elements are arranged in an increasing order of atomic number (Z), periodicity is observed in their electronic configuration and which reflects in the characteristic structure of the modern periodic table. The location of elements in the modern periodic table is correlated to quantum numbers of the last filled orbital. Let us have a deeper look into the electronic configuration of the elements and the structure of the modern periodic table.

7.3.1 Electronic configuration in periods

We noted earlier that periods in the modern periodic table are numbered 1 to 7. On inspection of the electronic configurations (see Fig. 7.3) of elements in various periods we understand that the period number is same as the principal quantum number ' n ' of the outermost or valence shell of the elements.

Along a period the atomic number increases by one and one electron is added to outermost shell which forms neutral atom of the next element. Every period ends with complete octet configuration (or duplet in the case of the first period) of the valence shell and the next period begins with addition of electron to the next shell of higher energy compared to the previous period. The first shell, thus, gets filled along the **first period**. As the first shell can accommodate only two electrons, there are two elements in the first period, namely, H ($Z=1$): $1s^1$ and He ($Z=2$): $1s^2$. The first period ends at 'He' because 'He' has complete duplet.

Electrons are filled in the second shell along the **second period**. The second period, thus, begins with Li ($Z=3$): $1s^2 2s^1$ and ends up with Ne ($Z=10$): $1s^2 2s^2 2p^6$. 'Ne' with 8 electrons in its outermost second shell has complete octet. The second shell has electron capacity of 8. It gets filled along the second period, as the atomic number increases. Thus there are eight elements in the second period.

Similarly there are eight elements (Na ($Z=11$) to Ar ($Z=18$)) having the condensed electronic configurations described together as $[\text{Ne}]3s^1-23p^{1-6}$ in the **third period**, as a result of completion of the third shell.

The **fourth period** begins with filling of 4s subshell. The first two elements of the fourth period are K ($Z=19$): $[\text{Ar}] 4s^1$ and Ca ($Z=20$): $[\text{Ar}]4s^2$. According to the aufbau principle the next higher energy subshell is 3d, which can accommodate upto 10 electrons. Filling of the 3d-subshell results in the next 10 elements of the fourth period, from Sc : ($Z=21$) $[\text{Ar}] 4s^2 3d^1$ to Zn : ($Z=30$) $[\text{Ar}] 4s^2 3d^{10}$. After this the electrons enter the subshell 4p for the next six elements : Ga: ($Z = 31$) $[\text{Ar}] 4s^2 3d^{10} 4p^1$ to Kr : ($Z=36$) $[\text{Ar}] 4s^2 3d^{10} 4p^6$. The fourth period, thus, contains in all 18 elements ($2+10+6=18$).

The **fifth period** accommodates 18 elements as a result of successive filling of electrons in the 5s, 4d and 5p subshells.

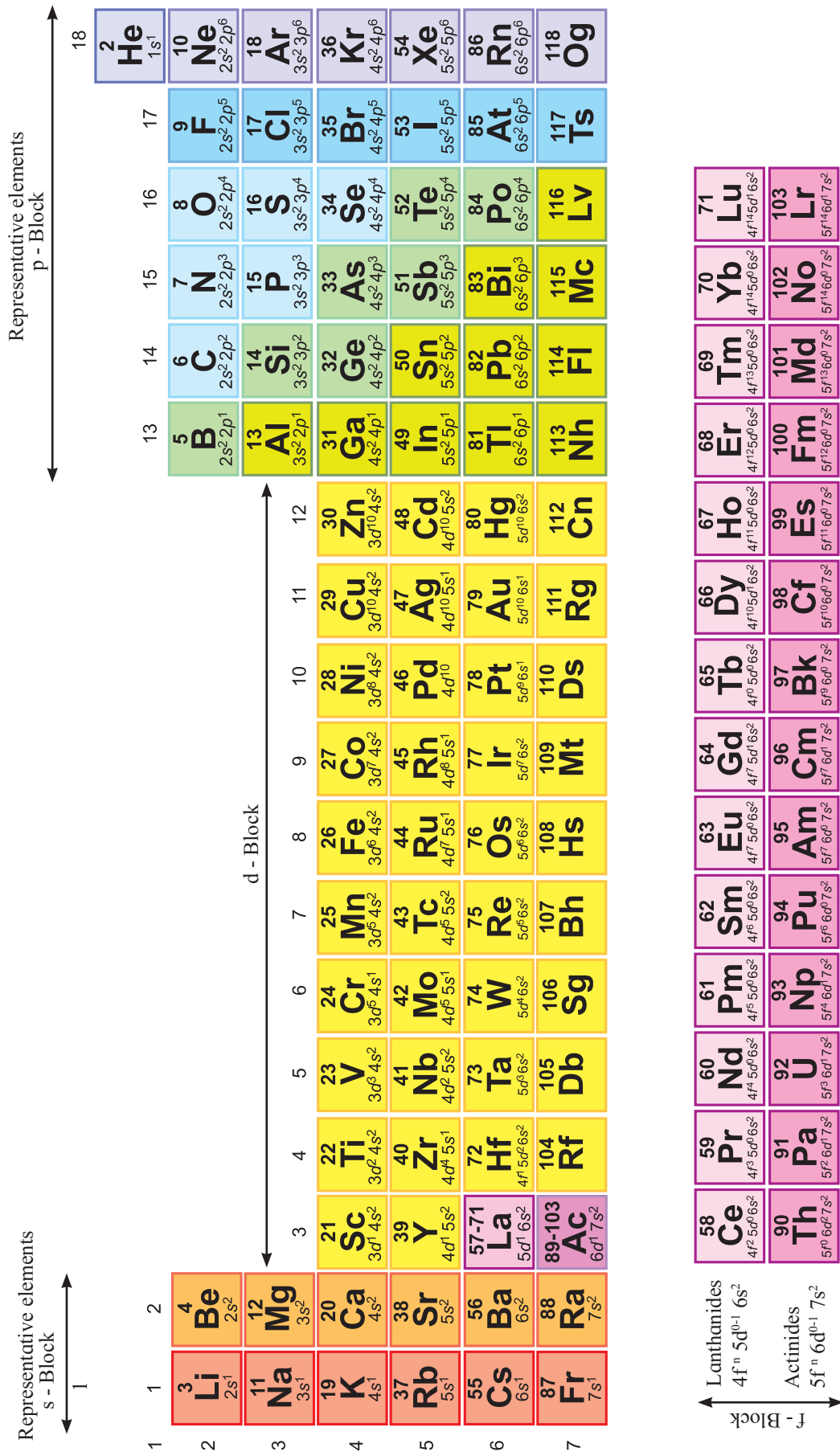

Fig. 7.2 : Outer electronic configuration of elements in the four blocks of the periodic table

Problem 7.1 : What is the subshell in which the last electron of the first element in the 6th period enters ?

Solution :

The 6th period begins by filling the last electron in the shell with $n=6$. The lowest energy subshell of any shell is 's'. Therefore the last electron of the first element in the 6th period enters the subshell '6s'.

Problem 7.2 : How many elements are present in the 6th period? Explain.

Solution :

The 6th period begins by filling the last electron in the subshell '6s' and ends by completing the subshell '6p'. Therefore, the sixth period has the subshells filled in increasing order of energy as $6s < 4f < 5d < 6p$. The electron capacities of these subshells are 2, 14, 10 and 6, respectively. Therefore, the total number of elements in the 6th period are $2+14+10+6 = 32$.

In short, a period begins by filling of one electron to the 's' subshell of a new shell and ends with an element having complete octet (or duplet) corresponding to the same shell. Between these two ends corresponding to 's' and 'p' subshell of the valence shell, the inner subshells 'd' and 'f' are filled successively following the aufbau principle.

7.3.2 Electronic configuration in groups

A new shell is added down a group. The general outer electronic configuration, therefore, is expected to be the same down any particular group. Indeed it is found to be so for the groups 1, 2 and 3. (See Fig. 7.2 and Table 7.1) In the groups 13 to 18 the appropriate inner 'd' and 'f' subshells are completely filled and the general outer electronic configuration is the same down the groups 13 to 18. (see Fig. 7.2 and Table 7.1).

In the groups 4 to 12, however, the 'd' and 'f' subshells are introduced at a later stage (4th period for 'd' and 6th period for 'f') down the group. As a result variation in the general outer configuration is introduced only at the later stage down the groups 4 to 12.

Table 7.1 : General outer electronic configuration in groups 1 to 3 and 13 to 18

Group number	General outer configuration	Examples
Group 1	ns^1	${}^3\text{Li}:2s^1, {}_{11}\text{Na}:3s^1$
Group 2	ns^2	${}^4\text{Be}:2s^2, {}_{12}\text{Mg}:3s^2$
Group 3	$ns^2 (n-1)d^1$	${}_{21}\text{Sc}:4s^23d^1, {}_{39}\text{Y}:5s^24d^1$
Group 13	$ns^2 np^1$	${}^5\text{B}:2s^22p^1, {}_{13}\text{Al}:3s^23p^1$
Group 14	$ns^2 np^2$	${}^6\text{C}:2s^22p^2, {}_{14}\text{Si}:3s^23p^2$
Group 15	$ns^2 np^3$	${}^7\text{N}:2s^22p^3, {}_{15}\text{P}:3s^23p^3$
Group 16	$ns^2 np^4$	${}^8\text{O}:2s^22p^4, {}_{16}\text{S}:3s^23p^4$
Group 17	$ns^2 np^5$	${}^9\text{F}:2s^22p^5, {}_{17}\text{Cl}:3s^23p^5$
Group 18	$ns^2 np^6$	${}_{10}\text{Ne}:2s^22p^6, {}_{18}\text{Ar}:3s^23p^6$

7.3.3 Electronic configuration in the four blocks:

We noted in section 7.2 that structure of the modern periodic table shows four blocks. These blocks are formed in accordance with the subshell in which the last electron enters. Accordingly the four blocks are named as s-block, p-block, d-block and f-block.

s-Block : The last electron in the s-block elements is filled in a s-subshell. There being only one orbital in a s-subshell, the general outer electronic configuration of s-block elements is ns^{1-2} . Thus elements of the group-1 and group-2 belong to the s-block. The s-block is present on the left extreme of the modern periodic table.

p-Block: The last electron in the p-block elements is filled in p-subshell. There being three degenerate p-orbitals in a p-subshell, upto 6 electrons can be filled. Therefore, the elements belonging to six groups, namely, group 13, 14, 15, 16, 17 and 18 constitute the p-block. The p-block appears on the right in the modern periodic table. The p-block ends with the group 18 which represent the family of inert gases. Remarkably, the first element of the group 18, helium (He) does not the p subshell as its valence shell has $n = 1$ and its configuration is shown as $1s^2$. Yet 'He' is placed in the 18th group of the p-block because its valence shell is completely filled (which is a complete duplet), similar to complete valence shell of the other elements belongin to group 18 (which have complete octets). The general electronic configuration for the p-block (from the second to the seventh period) is $ns^2 np^{1-6}$.

d-Block : The d-block in the modern periodic table is formed as a result of filling the last electron in d-orbital. A d-subshell is present in the shells with $n \geq 3$ and according to the $(n+l)$ rule (refer to Chapter 4) the energy of ns orbital is less than that of the $(n-1)d$ orbital. As a result, the last electron enters a $(n-1)d$ -subshell only after the ns subshell is completely filled. There being five orbitals in a d-subshell, 10 electrons can successively be accommodated. There are

ten groups, namely, groups 3, 4, 5, 6, 7, 8, 9, 10, 11 and 12 in the d-block which appears in the centre of the modern periodic table. The general outer electronic configuration of the d-block elements is $ns^{0-2} (n-1)d^{1-10}$. Some variations in the configuration, consequent to the extra stability associated with half-filled and a fully filled subshell, are readily observed. For example, the outer electronic configuration of Cr ($Z = 24$) is $4s^1 3d^5$ instead of $4s^2 3d^4$. This is because both 4s and 3d subshells are half-filled.

f-Block : In the f-block elements the last electron is filled in f-orbital. As there are seven orbitals in a f-subshell, the general outer electronic configuration of the f-block is $ns^2 (n-1)d^{0-1} (n-2)f^{1-14}$. The variations as a result the extra stability of half-filled and fully filled subshell need to be accounted for. For example, the outer electronic configuration of ${}_{63}\text{Eu}$ is $6s^2 4f^7 5d^0$ because the 4f subshell is half-filled. The f-block constitutes two series of 14 elements called the **lanthanide** and the **actinide series**, put one below the other. The f-block is placed separately at the bottom of the periodic table.

Problem 7.3 : Outer electronic configurations of a few elements are given below. Explain them and identify the period, group and block in the periodic table to which they belong.

${}_2\text{He} : 1s^2$, ${}_{54}\text{Xe} : 5s^2 5p^6$, ${}_{16}\text{S} : 3s^2 3p^4$, ${}_{79}\text{Au} : 6s^1 5d^{10}$

Solution :

${}_2\text{He} : 1s^2$

Here $n = 1$. Therefore, ${}_2\text{He}$ belongs to the **1st period**. The shell $n = 1$ has only one subshell, namely 1s. The outer electronic configuration $1s^2$ of 'He' corresponds to the maximum capacity of 1s, the **complete duplet**. Therefore, He is placed at the end of the **1st period in the group 18** of inert

gases, so 'He' belongs to **p-block**.

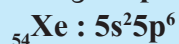

Here $n = 5$. Therefore, ${}_{54}\text{Xe}$ belongs to the **5th period**. The outer electronic configuration $5s^25p^6$ corresponds to **complete octet**. Therefore ${}_{54}\text{Xe}$ is placed in **group 18** and belongs to **p-block**.

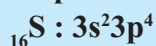

Here $n = 3$. Therefore, ${}_{16}\text{S}$ belongs to the **3rd period**. The 3p subshell in 'S' is partially filled and short of completion of octet by two electrons. Therefore 'S' belongs to $(18 - 2) = 16^{\text{th}}$ **group** and **p - block**.

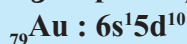

Here $n = 6$. Therefore, 'Au' belongs to the **6th period**. The sixth period begins with filling of electron into 6s and then into 5d orbital. The outer configuration of 'Au' : $6s^1 5d^{10}$ implies that $(1+10) = 11$ electrons are filled in the outer orbitals to give 'Au'. Therefore 'Au' belongs to the **group 11**. As the last electron has entered 'd' orbital 'Au' belongs to the **d-block**.

7.4 Blockwise characteristics of elements

We have seen in the previous section that the 118 elements in the modern periodic table are distributed in four blocks having general electronic configuration according to their block. The elemental properties are characteristic of the block they belong.

7.4.1 Characteristics of s-block elements

The s-block contains the elements of **group 1 (alkali metals)** and **group 2 (alkaline earth metals)**. All these elements are **reactive metals**, and occur in nature only in combined state. Their **compounds**, with exception of Li and Be, are **predominantly ionic**. This is because they have only one or two valence electrons which they can lose readily forming M^{\oplus} or $M^{2\oplus}$ ions. They have **low ionization enthalpies**, which decrease down the group resulting in increased reactivity.

7.4.2 Characteristics of p-block elements :

The p-block contains elements of **groups 13 to 18**. The **p-block elements together with s-block elements** are called **main group elements** or **representative elements**. The last group of the p-block, namely, the **18th group**, is the family of **noble/inert gases**. These have closed valence shells (complete duplet in the case of 'He' and complete octet in the case of the other noble gases) and therefore very low chemical reactivity. Elements of **group 17 (halogen family)** and **group 16 (chalcogens)** include **reactive nonmetals**. The **electron gain enthalpies** being **highly negative**, they gain one or two electrons readily and form anions (X^{\ominus} or $X^{2\ominus}$) which have complete octet. The p-block contains **all the three traditional types of elements**. The metals on the left, the nonmetals on the right and the metalloids along a **zig-zag line** (see Fig. 7.1) which separates metals from nonmetals. The nonmetallic character increases as we move from the left to the right, whereas it decreases as we go down a group.

7.4.3 Characteristics of d-block elements

The d-block contains elements of the **groups 3 to 12**. They are **all metals**. The d-block elements are known as **transition elements** or **transition metals**. They form a bridge between chemically reactive s-block elements and less reactive elements of groups 13 and 14. Most of d-block elements possess partially filled inner d-orbitals. As a result the d-block elements have properties such as **variable oxidation state**, **paramagnetism**, **ability to form coloured ions**. They can be used as **catalysts**. Zn, Cd, and Hg with configuration $ns^2 (n-1) d^{10}$, (completely filled s - and d - subshells) do not show the properties typical of transition metals.

7.4.4 Characteristics of f-block elements

The f-block contains elements **all** of which are **metals** and are placed in the two rows called **lanthanide series** (${}_{58}\text{Ce}$ to ${}_{71}\text{Lu}$) and **actinide**

series (${}_{90}\text{Th}$ to ${}_{103}\text{Lr}$). These series are named after their preceding elements lanthanum (${}_{57}\text{La}$) and actinium (${}_{89}\text{Ac}$) in the third group of the d-block of the 6th and 7th period respectively. The lanthanides are also known as **rare earth elements**. The last electron of the elements of these series is filled in the $(n-2)f$ subshell, and therefore, these are called **inner-transition elements**. These elements have very similar properties within each series. The actinide

Problem 7.4 : Chlorides of two metals are common laboratory chemicals and both are colourless. One of the metals reacts vigorously with water while the other reacts slowly. Place the two metals in the appropriate block in the periodic table. Justify your answer.

Solution

Metals are present in all the four blocks of the periodic table. Salts of Metals in the f-block and p-block (except AlCl_3) are not common laboratory chemicals. Therefore, the choice is between s- and d-block. From the given properties their placement is done as shown below:

s-block: Metal that reacts vigorously with water

d-block: Metal that reacts slowly with water.

The colourless nature of the less reactive metal in the d-block implies that the inner d-subshell is completely filled.

elements beyond ${}_{92}\text{U}$ are called **transuranium elements**. All the transuranium elements are manmade and radioactive.

7.5 Periodic trends in elemental properties

The original structure of the periodic table was based on empirically observed periodicity in the elemental properties. Thus, elemental properties show similarity in a group and show gradual variation across a period. The quantum mechanical model of atom explains the observed periodic trends of elemental

properties. We will now discuss in this section the periodic trends in some physical and chemical properties of elements, correlating them with electronic configuration and the nuclear charge. These trends are explained in terms of two fundamental factors, namely, attraction of extranuclear electrons towards the nucleus and repulsion between electrons belonging to the same atom. These attractive and repulsive forces operate simultaneously in an atom. This results in two interrelated phenomena called effective nuclear charge and screening effect.

7.5.1 Effective nuclear charge and screening effect :

In a multi-electron atom the positively charged nucleus attracts the negatively charged electrons around it, and there is mutual repulsion amongst the negatively charged extranuclear electrons. The repulsion by inner-shell electrons is particularly important. This results in pushing the outer-shell electrons further away from the nucleus. The outer-shell electrons are, thus, held less tightly by the nucleus. In other words, the attraction of the nucleus for an outer electron is partially cancelled. It means that an outer-shell electron does not experience the actual positive charge present on the nucleus. The net nuclear charge actually experienced by an electron is called the **effective nuclear charge, Z_{eff}** . The effective nuclear charge is lower than the actual nuclear charge, Z . In other words, the inner electrons shield the outer electrons from the nucleus to a certain extent. This effect of the inner electrons on the outer electrons is called **screening effect** or **shielding effect** of the inner/core electrons.

$$\begin{aligned} \text{Effective nuclear charge} &= Z_{\text{eff}} \\ &= Z - \text{electron shielding} \\ &= Z - \sigma \end{aligned}$$

Here σ (sigma) is called **shielding constant** or **screening constant** and the value of σ depends upon type of the orbital that the electron occupies.

As we move across a period actual nuclear charge increases by +1 at a time, the valence shell remains the same and the newly added electron gets accommodated in the same shell. There is no addition of electrons to the core. Thus, shielding due to core electrons remains the same though the actual nuclear charge, Z , increases. The net result is that **the effective nuclear charge, Z_{eff} , goes on increasing across a period.** On the other hand, the Z_{eff} decreases down a group. This is because, as we move down a group, a new larger valence shell is added. As a result, there is an additional shell in the core. The shielding effect of the increased number of core electrons outweighs the effect of the increased nuclear charge; and thereby **the effective nuclear charge felt by the outer electrons decreases largely down a group.**

7.5.2 Periodic trends in physical properties

Many physical properties of elements such as melting point, boiling point and density show periodicity. In this section we are going to consider the periodic trends in physical properties with reference to atomic radius, ionic radius, ionization enthalpy, electron gain enthalpy and electronegativity.

a. Atomic radius : You have learnt in chapter 4 that the quantum mechanical model of atom describes the extranuclear part of atom as the electron cloud. As a direct implication of this, the atom has no definite boundary. The atomic size or atomic radius, therefore, can be estimated from the internuclear distance under different circumstances. In the case of nonmetals (except noble gases), the atoms of an element are bonded to each other by covalent bonds. (Refer to Chapter 5). Bond length of a single bond is taken as sum of radii of the two single bonded atoms. This is called covalent radius of the atom. For example : (i) Bond length of C-C bond in diamond is 154 pm. Therefore, atomic radius of carbon

is estimated to be 77 pm. (ii) Bond length of Cl-Cl bond in Cl_2 is measured as 198 pm. Therefore, the atomic radius of Cl is estimated to be 99 pm. (see Fig. 6.3)

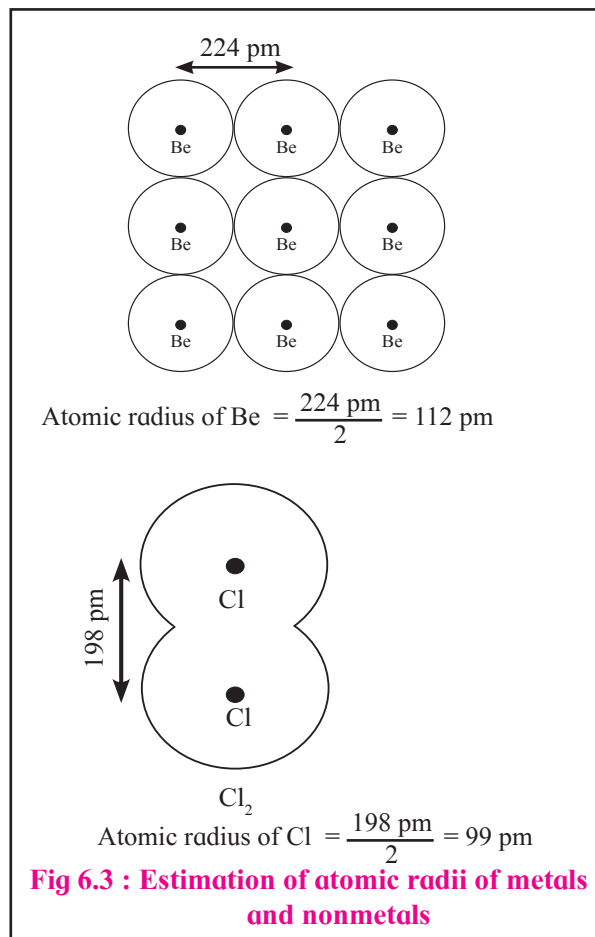

In the case of metals, distance between the adjacent atoms in metallic sample is measured. One half of this distance is taken as the metallic radius. **Thus, atomic radius is one half of the internuclear distance between two adjacent atoms of a metal or two single bonded atoms of a nonmetal.**



Do you know ?

Atomic radius is estimated in terms of the electron density surface which encloses typically 95 % (or more, which is arbitrary) of the electron density.

Table 7.2 : Atomic radii of some elements

Element symbol (atomic radius / pm)							
Group \ Period	1	2	13	14	15	16	17
2	Li (152)	Be (111)	B (88)	C (77)	N (74)	O (66)	F (64)
3	Na (186)	Mg (160)	Al (143)	Si (117)	P (110)	S (104)	Cl (99)
4	K (231)						Br (114)
5	Rb (244)						I (133)
6	Cs (262)						At (140)

It can be seen from Table 7.2 that atomic radius decreases across a period (upto group 17) and increases down a group. Greater the effective nuclear charge stronger is attraction of the nucleus for the outer electrons and smaller is the atomic radius. As we move across a period, screening effect caused by the core electrons remains the same, on the other hand the effective nuclear charge goes on increasing (see section 6.5.1). The valence electrons are, therefore, more tightly bound and in turn the atomic radius goes on decreasing along a period. The effective nuclear charge decreases and shielding effect increases down a group (see section 7.5.1). The valence electrons are, thus, held by weaker attractive force and the atomic radius increases down a group.

b. Ionic radius: An atom forms a positively charged ion, cation, on the removal of one or more electrons whereas a negatively charged ion, anion, is formed with gain of one or more electrons. Measurements of distances between neighbouring cations and anions in ionic crystals have been useful for estimation of ionic radii. The ionic radii show the same trends as of atomic radii.

A cation is smaller than the atom from which it is formed, because it contains fewer electrons than atom, though the nuclear charge is the same. As a result the shielding effect is less and effective nuclear charge is larger within a cation.

An anion has a larger radius than the corresponding atom, as it has more number of electrons than the atom. These additional electrons result in increased electron repulsion, decreased effective nuclear charge and in turn, the increased size.

Some atoms and ions contain the same number of electrons and are called **isoelectronic species**. (See chapter 4) The actual nuclear charge of the isoelectronic species is, however, different. The radii of isoelectronic species vary according to actual nuclear charge. Larger nuclear charge exerts greater attraction for the electrons and the radius of that isoelectronic species becomes smaller. For example, F^{\ominus} and Na^{\oplus} both have 10 electrons, their radii are 133 pm and 98 pm respectively, as the nuclear charge of F^{\ominus} is +9 which is smaller than that of Na^{\oplus} which is, +11.

c. Ionization enthalpy : Removal of an electron from the neutral atom X results

Problem 7.5 : Identify the species having larger radius from the following pairs : (i) Na and Na^{\oplus} , (ii) Na^{\oplus} and $Mg^{2\oplus}$

Solution :

(i) The nuclear charge is the same in Na and Na^{\oplus} . But Na^{\oplus} has less number of electrons and less number of occupied shells (two shells in Na^{\oplus} while three shells in Na). Therefore, radius of Na is larger. (ii) Na^{\oplus} and $Mg^{2\oplus}$ are isoelectronic species. $Mg^{2\oplus}$ has larger nuclear charge than Na^{\oplus} . Therefore, Na^{\oplus} has larger radius.

in formation of cation X^{\oplus} . The energy required to remove an electron from the isolated gaseous atom in its ground state is called ionization enthalpy ($\Delta_i H$). Ionization enthalpy is the quantitative measure of tendency of an element to lose electron and expressed in kJ mol^{-1} . Since electrons are lost one at a time, we have first ionization enthalpy, second ionization enthalpy, and so on, for a given element.

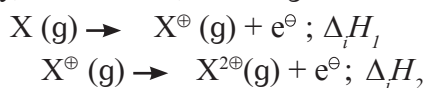

Ionization enthalpy is always positive since the energy always need to be supplied to knock out electron from atom.

The second ionization enthalpy, $\Delta_i H_2$, is larger than the first ionization enthalpy, $\Delta_i H_1$, as it involves removal of electron from the positively charged species. Tables 6.3 and 6.4 show the values of first ionization enthalpy down the group 1 and across the period 2 respectively.

It is seen from Table 7.3 that on moving down the group the first ionization enthalpy decreases. This is because electron is to be removed from the larger valence shell. Screening due to core electrons goes on increasing and the effective nuclear charge decreases down the group. (See section 7.5.1) The removal of the outer electron, therefore, becomes easier more and more easy.

Table 7.3 : First ionization enthalpy values of elements of group 1

Elements of Group 1	Atomic Number Z	Outer electronic configuration	$\Delta_i H_1 / \text{kJ mol}^{-1}$
Li	3	$2s^1$	520
Na	11	$3s^1$	496
K	19	$4s^1$	419
Rb	37	$5s^1$	403
Cs	55	$6s^1$	374

An overall increase of the first ionization enthalpy across the period 2 (see table 7.4) can be notice. This is because the screening is the same and the effective nuclear charge increases across a period. (See section 7.5.1) As a result the outer electron is held more tightly. The first ionization enthalpy, therefore, increases across a period. The alkali metal displays the lowest first ionization enthalpy. The inert gas shows the highest first ionization enthalpy across a period.

Some irregularities are noticed for the first ionization enthalpies as we move across a period. For example, the first ionization enthalpy of 'B' is smaller than that of 'Be'. This is because 'Be' loses the electron from 2s orbital while 'B' loses the electron from 2p orbital which has less penetration (see shapes of orbitals in chapter 4) than the 2s orbital and therefore it is easier to remove a 2p electron than a 2s electron. Similarly, first ionization enthalpy of 'O' is smaller than that of 'N'. This is because 'O' loses the electron from a doubly occupied '2p' orbital. Due to

Table 7.4 : First ionization enthalpy values of elements of period 2

Element of period 2	Li	Be	B	C	N	O	F	Ne
Atomic number Z	3	4	5	6	7	8	9	10
Outer electronic Configuration	$2s^1$	$2s^2$	$2s^2 2p^1$	$2s^2 2p^2$	$2s^2 2p^3$	$2s^2 2p^4$	$2s^2 2p^5$	$2s^2 2p^6$
$\Delta_i H_1 / \text{kJ mol}^{-1}$	520	899	801	1086	1402	1314	1681	2080

(ii) F and O belong to the same second period, with F having higher atomic number than O. As the atomic number increases across a period, atomic radius decreases, effective nuclear charge increases and electron can be added more easily. Therefore more energy is released with gain of an electron as we move to right in a period. Therefore, F has more negative electron gain enthalpy.

e. Electronegativity: When two atoms of different elements form a covalent bond, the electron pair is shared unequally. **The ability of a covalently bonded atom to attract the shared electrons toward itself is called electronegativity (EN).** It is not an experimentally measurable quantity. A number of numerical scales of electronegativity were developed by many scientists. Pauling scale of electronegativity is the one used most widely. **Linus Pauling assigned (1922) arbitrarily a value of 4.0 for fluorine which is expected to have the highest value of electronegativity.** Table 7.5 shows the values of electronegativity assigned to some other elements.

Electronegativity represents attractive force exerted by the nucleus on shared electrons. Electron sharing between covalently bonded atoms takes place using the valence electron. The electronegativity depends upon the effective nuclear charge experienced by

electron involved in formation of the covalent bond. Electronegativity increases as we move across the period. This is because the effective nuclear charge increases steadily across the period. The EN decreases down the group. The size of the valence shell goes on increasing, the shielding effect of the core electron goes on increasing and in term the effective nuclear charge decreases down the group.

Electronegativity predicts the nature of the bond, or, how strong is the force of attraction that holds two atoms together. (Refer Chapter 5).

7.5.3 Periodic trends in chemical properties:

The most fundamental chemical property of an element is its combining power. This property is numerically expressed in terms of **valency** or **valence**. Valency of an element indicates the number of chemical bonds that the atom can form giving a molecule. Another frequently used term related to valence is the **oxidation state** or **oxidation number**. Valence does not have any sign associated with it, but oxidation number does, and can be either + or -, which is decided by electronegativities of atoms that are bonded.

The second aspect of chemical property is the **chemical reactivity**. The chemical reactivity is related to the ease with which an element loses or gains the electrons.

The chemical properties of elements are relate to electronic configuration.

Table 7.5 : Electronegativity (EN) values of some elements (Pauling scale)

Element symbol (EN)							
Group \ Period	1	2	13	14	15	16	17
1	H (2.1)						
2	Li (1.0)	Be (1.5)	B (2.0)	C (2.5)	N (3.0)	O (3.5)	F (4.0)
3	Na (0.9)	Mg (1.2)	Al(1.5)	Si (1.8)	P (2.1)	S (2.5)	Cl (3.0)
4	K (0.8)						Br (2.8)
5	Rb (0.8)						I (2.5)
6	Cs (0.7)						At (2.2)

Table 7.6 : Periodic trends in valency of main group elements

Group	1	2	13	14	15	16	17	18
General outer electronic configuration	ns^1	ns^2	ns^2np^1	ns^2np^2	ns^2np^3	ns^2np^4	ns^2np^5	ns^2np^6
Number of valence electrons	1	2	3	4	5	6	7	8
Valency	1	2	3	4	3,5	2,6	1,7	0
Formula of hydride	LiH	BeH ₂	B ₂ H ₆	CH ₄	NH ₃	H ₂ O	HF	
	NaH	MgH ₂	AlH ₃	SiH ₄	PH ₃	H ₂ S	HCl	
	KH	CaH ₂	GaH ₃	GeH ₄	AsH ₃	H ₂ Se	HBr	
Formula of oxide	Li ₂ O	BeO	B ₂ O ₃	CO ₂	N ₂ O ₃ N ₂ O ₅		OF ₂	
	Na ₂ O	MgO	Al ₂ O ₃	SiO ₂	P ₄ O ₆ , P ₂ O ₅	SO ₂ , SO ₃	Cl ₂ O ₇	
	K ₂ O	CaO	Ga ₂ O ₂	GeO ₂	As ₂ O ₃ , As ₂ O ₅	SeO ₂ , SO ₃	Br ₂ O	

a. Periodic trends in valency: Valency of the main group elements is usually equal to the number of valence electrons (outer electrons) and/or equal to difference between 8 and the number of valence electrons. Table 7.6 shows the periodic trends in the valency of main group elements by taking examples of hydrides and some oxides.

As may be notice form Table 7.6 that the valency remains the same down the group and shows a gradual variation across the period as atomic number increases from left to right.

b. Periodic trends in metallic–nonmetallic character : The metals, nonmetals and metalloids appear in separate regions of modern periodic table: metals on the left, nonmetals on the right and metalloids along a zig-zag line separating the two. Metals are characterized by good electrical conductivity and ability to form compounds by loss of valence electrons. Nonmetals are characterized by their poor electrical conductivities and ability to form compounds by gain of valence electrons in valence shell. This can be explained in terms of ionization enthalpy and electron gain enthalpy.

The ionization enthalpy decreases down the group. The tendency to lose valence electrons, thus, increases down the group and the **metallic character increases down a group**. The ionization enthalpy increases across the period and consequent **metallic character decreases across a period**. Electron gain enthalpy becomes more and more negative across the period, it becomes tends to be less negative down the group. Thus, **nonmetallic character increases across the period and decreases down the group**.

c. Periodic trends in chemical reactivity: Chemical reactivity of elements is decided by how easily it attains electronic configuration of the nearest inert gas by gaining or loosing electrons.

The elements preceding an inert gas react by gaining electrons in the outermost shell, whereas the elements which follow an inert gas in the periodic table react by loss of valence electrons. Thus the chemical reactivity is decided by the electron gain enthalpy and ionization enthalpy values, which in turn, are decided by effective nuclear charge and finally by the atomic size. The ionization enthalpy is smallest for the element on the extreme left in

a period, whereas the electron gain enthalpy is most negative for the second last element on the extreme right, (preceding to the inert gas which is the last element of a period). Thus, the most reactive elements lie on the extreme left and the extreme right (excluding inert gases) of the periodic table.

Apart from the metallic-nonmetallic character the chemical reactivity can be illustrated by comparing their reaction with oxygen to form oxides and the nature of the oxides. The reactive elements on the extreme left (that is, alkali metals) react vigorously with oxygen to form oxides (for example Na_2O) which reacts with water to form strong bases (like NaOH). The reactive elements on the right (that is, halogens) react with oxygen to form oxides (for examples Cl_2O_7) which on reaction with water form strong acids (like HClO_4). The oxides of the elements in the center of the main group elements are either amphoteric (for example Al_2O_3), neutral (for example CO , NO) or weakly acidic (for example CO_2)

The change in atomic radii of transition metals and inner transition elements is rather small. Therefore, the transition metals and inner transition elements belonging to the individual series have similar chemical properties. Their ionization enthalpies are intermediate between those of s-block and p-block.

Problem 7.8 :

Ge, S and Br belong to the groups 14, 16 and 17, respectively. Predict the empirical formulae of the compounds those can be formed by (i) Ge and S, (i) Ge and Br.

Solution :

From the group number we understand that the general outer electronic configuration and number of valence electrons and valencies of the three elements are :

Element	Group	Outer electronic configuration	Number of Valence electron	Valency
Ge	14	ns^2np^2	4	4
S	16	ns^2np^4	6	$8 - 6 = 2$
Br	17	ns^2np^5	7	$8 - 7 = 1$

(i) S is more electronegative than Ge. Therefore, the empirical formula of the compound formed by these two elements is predicted by the method of cross multiplication of the valencies :

Element: Ge S
Valency: 4 2

Formula: Ge_2S_4

Empirical formula: GeS_2

(ii) Br is more electronegative than Ge. The empirical formula of the compound formed by these two elements in predicted by the method of cross multiplication of valencies :

Element: Ge Br
Valency: 4 1

Formula: GeBr_4

Empirical formula: GeBr_4

Problem 7.9

Write the chemical equations for reaction, if any, of (i) Na_2O and (ii) Al_2O_3 with HCl and NaOH both. Correlate this with the position of Na and Al in the periodic table, and infer whether the oxides are basic, acidic or amphoteric.

Solution

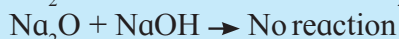

As Na_2O reacts with an acid to form salt and water it is a basic oxide. This is because Na is a reactive metal lying on the extreme left of the periodic table.

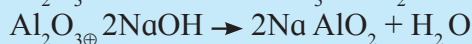

As Al_2O_3 reacts with an acid as well as base to form a salt and water. It is an amphoteric oxide. Al is a moderately reactive element lying in the centre of main group elements in the periodic table.



Exercises

1. Explain the following

- The elements Li , B , C , Be and N have the electronegativities 1.0, 2.0, 1.5 and 3.0, respectively on the Pauling scale.
- The atomic radii of Cl , I and Br are 99, 133 and 114 pm, respectively.
- The ionic radii of F^\ominus and Na^\oplus are 133 and 98 pm, respectively.
- ${}_{13}\text{Al}$ is a metal, ${}_{14}\text{Si}$ is a metalloid and ${}_{15}\text{P}$ is a nonmetal.
- Cu forms coloured salts while Zn forms colourless salts.

2. Write the outer electronic configuration of the following using orbital notation method. Justify.

- Ge (belongs to period 4 and group 14)
- Po (belongs to period 6 and group 16)
- Cu (belongs to period 4 and group 11)

3. Answer the following

- La belongs to group 3 while Hg belongs to group 12 and both belong to period 6 of the periodic table. Write down the general outer electronic configuration of the ten elements from La to Hg together using orbital notation method.
- Ionization enthalpy of Li is 520 kJ mol^{-1} while that of F is 1681 kJ mol^{-1} . Explain.
- Explain the screening effect with a suitable example.

- Why the second ionization enthalpy is greater than the first ionization enthalpy?
- Why the elements belonging to the same group do have similar chemical properties?
- Explain : electronegativity and electron gain enthalpy. Which of the two can be measured experimentally?

4. Choose the correct option

- Consider the elements B , Al , Mg and K predict the correct order of metallic character :
 - $\text{B} > \text{Al} > \text{Mg} > \text{K}$
 - $\text{Al} > \text{Mg} > \text{B} > \text{K}$
 - $\text{Mg} > \text{Al} > \text{K} > \text{B}$
 - $\text{K} > \text{Mg} > \text{Al} > \text{B}$
- In modern periodic table, the period number indicates the :
 - atomic number
 - atomic mass
 - principal quantum number
 - azimuthal quantum number

- C. The lanthanides are placed in the periodic table at
- left hand side
 - right hand side
 - middle
 - bottom
- D. If the valence shell electronic configuration is ns^2np^5 , the element will belong to
- alkali metals
 - halogens
 - alkaline earth metals
 - actinides
- E. In which group of elements of the modern periodic table are halogen placed ?
- 17
 - 6
 - 4
 - 2
- F. Which of the atomic number represent the s-block elements ?
- 7, 15
 - 3, 12
 - 6, 14
 - 9, 17
- G. Which of the following pairs is NOT isoelectronic ?
- Na^\oplus and Na
 - $\text{Mg}^{2\oplus}$ and Ne
 - $\text{Al}^{3\oplus}$ and $\text{B}^{3\oplus}$
 - $\text{P}^{3\ominus}$ and $\text{N}^{3\ominus}$
- H. Which of the following pair of elements has similar properties ?
- 13, 31
 - 11, 20
 - 12, 10
 - 21, 33

5. Answer the following questions

- A. The electronic configuration of some elements are given below:
- $1s^2$
 - $1s^2 2s^2 2p^6$
- In which group and period of the periodic table they are placed ?
- B. For each of the following pairs, indicate which of the two species is of large size :
- Fe^{2+} or Fe^{3+}
 - Mg^{2+} or Ca^{2+}
- C. Select the smaller ion form each of the following pairs:
- K^+ , Li^+
 - N^{3-} , F^-

- D. With the help of diagram answer the questions given below:

	Li	Be																	

- Which atom should have smaller ionization energy, oxygen or sulfur?
 - The lithium forms +1 ions while beryllium forms +2 ions ?
- E. Define :
- Ionic radius
 - Electronegativity
- F. Compare chemical properties of metals and non metals.
- G. What are the valence electrons ? For s-block and p-block elements show that number of valence electrons is equal to its group number.
- H. Define ionization energy. Name the factors on which ionisation energy depends? How does it vary down the group and across a period?
- I. How the atomic size vary in a group and across a period? Explain with suitable example.
- J. Give reasons.
- Alkali metals have low ionization energies.
 - Inert gases have exceptionally high ionization potential.
 - Fluorine has less electron affinity than chlorine.
 - Noble gases possess relatively large atomic size.
- K. Consider the oxides Li_2O , CO_2 , B_2O_3 .
- Which oxide would you expect to be the most basic?
 - Which oxide would be the most acidic?
 - Give the formula of an amphoteric oxide.



Activity :

Prepare a wall mounting chart of the modern periodic table.

8. Elements of Groups 1 and Group 2

We have seen in chapter 7 that the element of group 1 and group 2 belong to the s-block of the modern periodic table.



Can you recall?

1. Which is the first element in the periodic table ?
2. What are isotopes ?
3. Write the formulae of the compounds of hydrogen formed with sodium and chlorine.

Hydrogen is the first element in the periodic table. Hydrogen appears at the top of group 1 of the alkali metals. But it differs from alkali metals in a number of respects and, therefore, is studied separately.

8.1 Hydrogen : Hydrogen has the simplest atomic structure of all the elements. A hydrogen atom consists of a nucleus of charge +1 and one extranuclear electron. Hydrogen has a little tendency to lose this electron however can pair with the other electron easily forming a covalent bond. It exists in diatomic form as H_2 molecule; therefore it is often called **dihydrogen**.

8.1.1 Occurrence : In the free state hydrogen exists as dihydrogen gas. Hydrogen is most abundant element in the universe; it makes 70 % of the total mass of the universe. Hydrogen is also the principal element in the solar system. On the earth, hydrogen is the tenth most abundant element on mass basis and the third most abundant element on atom basis.

8.1.2 Position of hydrogen in the periodic table : Position of hydrogen in the periodic table has been a subject of discussion.



Can you tell?

In which group should hydrogen be placed ? In group 1 or group 17 ? Why ?

Electronic configuration of hydrogen is $1s^1$ which is similar to ns^1 which is the outer electronic configuration of alkali metals belonging to the group 1. But $1s^1$ also resembles the outer electronic configuration of group 17 elements, which is ns^2np^5 . By adding one electron to H we get electronic configuration of the inert gas He which is $1s^2$ and by adding one electron to ns^2np^5 we get ns^2np^6 which is the outer electronic configuration of the remaining inert gases. Some chemical properties of hydrogen are similar to those of alkali metals while some resemble halogens. The uniqueness of hydrogen is that H^\oplus formed by loss of the electron from hydrogen atom does not exist freely. It is always associated with other molecules. For example:



This is because H^\oplus is nothing else but a proton. Hydrogen is, therefore, placed separately above the group 1. It may be noted, here, that metastable metallic hydrogen was discovered at Harvard university, USA, in January 2017.

8.1.3 Isotopes of Hydrogen : If different atoms of the same element have different mass numbers they are called isotopes of each other. (Refer to chapter 4). Hydrogen has three isotopes with mass numbers 1, 2 and 3. They all contain one proton and one electron but different number of neutrons in the nucleus. (see figure 8.1 and table 8.1)

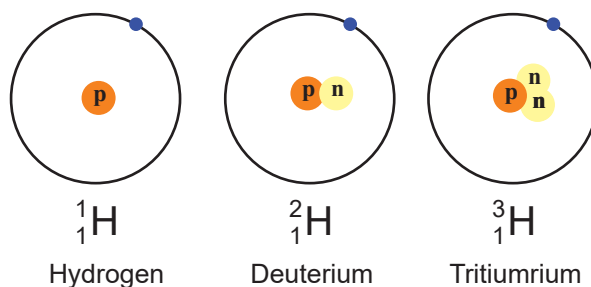

Figure 8.1 Isotopes of hydrogen

Table 8.1 : Characteristics of isotopes of hydrogen

Name of the Isotope	Symbol	Atomic number Z	Atomic mass number A	Neutron number N	Abundance	Stability
Hydrogen	H or ${}^1_1\text{H}$ or H-1	1	1	0	99.98 %	Stable
Deuterium	D or ${}^2_1\text{H}$ or H-2	1	2	1	0.015 %	Stable
Tritium	T or ${}^3_1\text{H}$ or H-3	1	3	2	Trace	Radio active



Do you know ?

Tritium ${}^3_1\text{H}$ is a radioactive nuclide with half life period 12.4 years and emits low energy β^- particles.

8.1.4 Preparation of dihydrogen

Hydrogen can be prepared using many methods.

A. Laboratory methods

i. Dihydrogen is prepared in laboratory by the action of dilute hydrochloric acid on zinc granules.

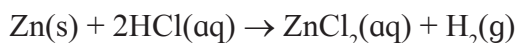

ii. Dihydrogen can be prepared by the action of aqueous solution of sodium hydroxide on zinc.

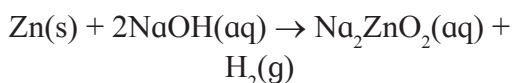

B. Industrial methods

i. **By electrolysis of pure water:** Pure water is a poor conductor of electricity. Therefore a dilute aqueous solution of acid or alkali is used to prepare dihydrogen by electrolysis. For example, electrolysis of dilute aqueous solution of sulphuric acid yields two volumes of hydrogen at cathode and one volume of oxygen at anode.

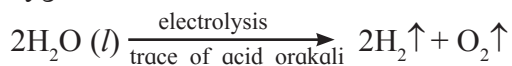

Pure dihydrogen (> 99.5% purity) gas is obtained by electrolysis of warm solution of barium hydroxide between nickel electrodes.

ii. **From carbon or hydrocarbon:** Three stages are involved in this industrial process of preparation of dihydrogen.

Stage 1 : Reaction of steam on hydrocarbon or coke (C) at 1270 K temperature in presence of nickel catalyst, gives water-gas, which is a mixture of carbon monoxide and hydrogen.

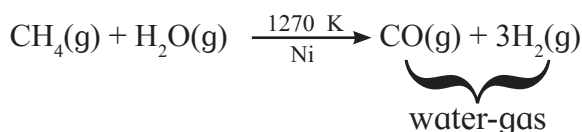

As water-gas is used for synthesis of CH_3OH and a number of hydrocarbons, it is also called 'syngas'. Production of syngas is also the first stage of gasification of coal.

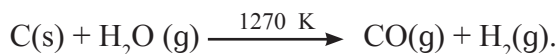

Sawdust, scrapwood, etc. can also be used in place of carbon.

Stage 2 : Water-gas shift reaction: The carbon monoxide in the watergas is transformed into carbondioxide by reacting with steam in presence of iron chromate as catalyst. This is called water-gas shift reaction.

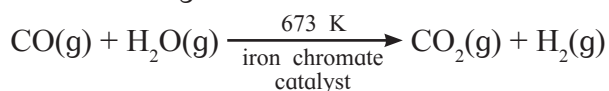

Stage 3 : Carbon dioxide is removed by scrubbing with sodium arsenite solution.

Today major industrial production of dihydrogen is from petrochemicals (~ 77 %), about 18 % from coal, about 4 % by electrolytic methods and about 1 % by other methods.

8.1.5 Properties of dihydrogen

A. Physical properties : Dihydrogen is colourless, tasteless and odourless gas. It burns with a pale blue flame. It is a nonpolar water insoluble gas, lighter than air.

B. Chemical properties :

i. Reaction with metals : Dihydrogen combines with all the reactive metals including alkali metals, calcium, strontium and barium at high temperature, to form metal hydrides. For example :

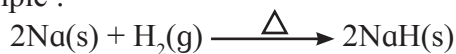

(In this respect dihydrogen is similar to halogens which also react with metals and form metal halides.)



Just think

In the above chemical reaction which element does undergo oxidation and which does undergo reduction ?



Do you know ?

The bond dissociation energy of H-H bond is high, which is 436 kJ mol^{-1} . Therefore reactions of dihydrogen take place at high temperature and /or in the presence of catalyst.

ii. Reaction with dioxygen: Dihydrogen reacts with dioxygen in the presence of catalyst or by heating to form water. This reaction is highly exothermic.

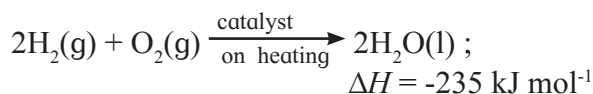

iii. Reaction with halogens: Dihydrogen inflames with fluorine even at -250°C in dark, whereas it requires catalyst to react with iodine. The vigour of reaction of dihydrogen decreases with increasing atomic number of halogen.

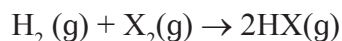

(In this respect dihydrogen resembles alkali metals which also react with halogens to form halides.)

iv. Reducing nature of dihydrogen :

a. Dihydrogen reduces oxides and ions of metals those are less reactive than iron, to the corresponding metals at moderate temperature. For example :



b. Hydrogenation of unsaturated organic compound

The hydrogenation of unsaturated organic compounds such as oil using nickel catalyst gives saturated organic compounds such as solid fat (vanaspati Ghee).

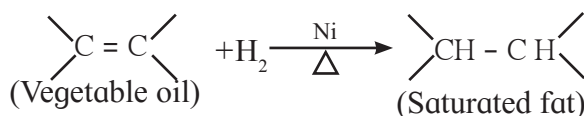

c. Hydroformylation of olefins and subsequent reduction of aldehyde to form alcohol

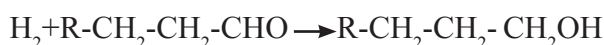
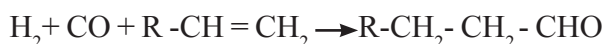

7.1.6 Uses of dihydrogen

- Largest use of dihydrogen is in production of ammonia.
 - Dihydrogen is used in formation of vanaspati ghee by catalytic hydrogenation of oils.
 - Liquid dihydrogen is used as a rocket fuel.
 - Dihydrogen is used in preparation of important organic compounds like methanol in bulk quantity.
- $$2\text{H}_2(\text{g}) + \text{CO(g)} \xrightarrow[\text{Cobalt catalyst}]{\text{Cobalt catalyst}} \text{CH}_3\text{OH(l)}$$
- Dihydrogen is used for preparation of hydrogen chloride (HCl) and metal hydrides.

Problem 8.1 : Justify the placement of hydrogen in the group of alkali metals with the help of reaction with halogens.

Solution :

Hydrogen on reaction with halogen (X_2) gives compounds with general formula HX. For example : $\text{H}_2 + \text{Cl}_2 \rightarrow 2\text{HCl}$ similarly alkali metals (M) on reaction with halogens (X_2) give compounds with general formula MX.

For examples : $2\text{Na} + \text{Cl}_2 \rightarrow 2\text{NaCl}$

Thus, H_2 and alkali metal are monovalent elements more electropositive than halogens. This similarly justifies the place of hydrogen in the group 1.



Can you recall?

1. What is the name of the family of reactive metals having valency one?
2. What is the name of the family of reactive metals having valency two?

8.2 Alkali metals and elements of group 2

8.2.1 Introduction : The elements of the groups 1 and 2 are placed on the left in the periodic table. Here the last electron enters into ' ns ' subshell. Thus they belong to the s-block of the periodic table. **Group 1** of the periodic table consists of the elements: **hydrogen, lithium, sodium, potassium, rubidium, caesium and francium**. These elements **except hydrogen** are collectively called **alkali metals**. We have already looked at hydrogen in the section 8.1. Two elements of Group 1, namely, sodium and potassium are the sixth and seventh most abundant elements in earth crust but francium does not occur appreciably in nature because it is radioactive and has short half-life period.

Group 2 of the periodic table consists of elements : **beryllium, magnesium, calcium, strontium, barium and radium**. These elements are collectively called **alkaline earth metals** because they occur as minerals in rocks. The elements magnesium and calcium are found abundantly elements in earth crust but radium is not easy to find. Radium is one of the first two radioactive elements discovered by Madame Curie.

8.2.2 Electronic configuration of elements of group 1 and group 2

The general outer electronic configuration of the group 1 elements is ns^1 and that of the group 2 elements is ns^2 . The loosely held s-electrons in valence shell of these elements can be easily removed to form metal ions. Hence these elements are never found in free state in nature. Tables 8.2 and 8.3 show the electronic configurations of the elements of group 1 and group 2 elements, respectively.

Table 8.2 : Electronic configuration of group 1 elements

Name	Symbol	Atomic number	Condensed electronic configuration	Electronic Configuration.
Hydrogen	H	1	$1s^1$	$1s^1$
Lithium	Li	3	$[\text{He}] 2s^1$	$1s^2 2s^1$
Sodium	Na	11	$[\text{Ne}] 3s^1$	$1s^2 2s^2 2p^6 3s^1$
Potassium	K	19	$[\text{Ar}] 4s^1$	$1s^2 2s^2 2p^6 3s^2 3p^6 4s^1$
Rubidium	Rb	37	$[\text{Kr}] 5s^1$	$1s^2 2s^2 2p^6 3s^2 3p^6 4s^2 3d^{10} 4p^6 5s^1$
Caesium	Cs	55	$[\text{Xe}] 6s^1$	$1s^2 2s^2 2p^6 3s^2 3p^6 4s^2 3d^{10} 4p^6 5s^2 4d^{10} 5p^6 6s^1$
Francium	Fr	87	$[\text{Rn}] 7s^1$	$1s^2 2s^2 2p^6 3s^2 3p^6 4s^2 3d^{10} 4p^6 5s^2 4d^{10} 5p^6 6s^2 4f^{14} 5d^{10} 6p^6 7s^1$

Table 8.3 : Electronic configuration of group 2 elements

Name	Symbol	Atomic number	Condense electronic configuration	Electronic Configuration.
Beryllium	Be	4	$[\text{He}] 2s^2$	$1s^2 2s^2$
Magnesium	Mg	14	$[\text{Ne}] 3s^2$	$1s^2 2s^2 2p^6 3s^2$
Calcium	Ca	20	$[\text{Ar}] 4s^2$	$1s^2 2s^2 2p^6 3s^2 3p^6 4s^2$
Strontium	St	38	$[\text{Kr}] 5s^2$	$1s^2 2s^2 2p^6 3s^2 3p^6 4s^2 3d^{10} 4p^6 5s^2$
Barium	Ba	56	$[\text{Xe}] 6s^2$	$1s^2 2s^2 2p^6 3s^2 3p^6 4s^2 3d^{10} 4p^6 5s^2 4d^{10} 5p^6 6s^2$
Radium	Ra	88	$[\text{Rn}] 7s^2$	$1s^2 2s^2 2p^6 3s^2 3p^6 4s^2 3d^{10} 4p^6 5s^2 4d^{10} 5p^6 6s^2 4f^{14} 5d^{10} 6p^6 7s^2$

8.2.3 Trends in atomic and physical properties of elements of group 1 and group 2

All the **alkali metals** are silvery white and soft. Due to their large atomic size these elements have low density. They are the most electropositive elements. The **alkaline earth metals** are also in general silvery white lustrous

and soft, but harder than the alkali metals. They are also strongly electropositive in nature. But comparatively less electropositive than the alkali metals. Some atomic and physical properties of the alkali metals and the alkaline earth metals are listed in the tables 8.4 and 8.5 respectively.

Table 8.4 : Physical properties of group 1 elements (except hydrogen)

Symbol	Atomic radius (pm)	Ionic radius (pm)	Density (g/cm ⁻³)	Ionization enthalpy (kJ mol ⁻¹)	Electro-negativity	Melting point (K)	Abundance in the lithosphere	Standard reduction potential E° (V)
Li	152	76	0.54	520	1.0	454	18 ppm	-3.04
Na	186	102	0.97	496	0.9	371	2.27 %	-2.714
K	227	138	0.86	419	0.8	336	1.84 %	-2.925
Rb	248	152	1.53	403	0.8	312	78.12 ppm	-2.930
Cs	265	167	1.90	376	0.7	302	2.6 ppm	-2.927
Fr	-	(180)	-	~375	-	-	-10 ⁻¹⁸ ppm	-

Table 8.5 : Physical properties of group 2 elements

Symbol	Atomic radius (pm)	Ionic radius (pm)	Density (g/cm ⁻³)	Ionization enthalpy (kJ mol ⁻¹)		Electro-negativity	Melting point (K)	Abundance in the lithosphere	Standard reduction potential E° (V)
				1 st	2 nd				
Be	111	31	1.84	899	1757	1.5	1560	2 ppm	-1.97
Mg	160	72	1.74	737	1450	1.2	924	2.76 %	-2.36
Ca	197	100	1.55	590	1145	1.0	1124	4.6 %	-2.84
Sr	215	118	2.63	549	1064	1.0	1062	384 ppm	-2.89
Ba	222	135	3.59	503	965	0.9	1002	390 ppm	-2.92
Ra	-	148	(5.5)	509	979	-	973	10 ⁻⁶ ppm	-2.92

Unipositive ions of all the elements of group 1 have inert gas configuration. Thus they have no unpaired electron and their compounds are diamagnetic and colourless. The divalent ions of group 2 elements also have inert gas configuration with no unpaired electron, and therefore their compounds are also diamagnetic and colourless. Lithium and beryllium differ from the rest of the elements of the groups 1 and 2, respectively because of their extremely small size and comparatively high electronegativity.

The physical properties of group 1 and group 2 elements show reasonable regularity in the periodic trends. Thus the atomic and ionic radii and densities increase down

both the groups. Ionization enthalpies and electronegativities decrease down both the groups. The elements of both these groups, in general, have high negative values of standard reduction potentials.

8.2.4 Chemical properties of elements of group 1 and group 2

The alkali metals and alkaline earth metals are very reactive in nature. As a result of this they are always found in combined state. Their reactivity is due to their low ionization enthalpy values in general. The reactivity of these metals increases with increasing atomic radius and corresponding lowering ionization enthalpy down the groups 1 and 2 can be noticed.

Problem 8.2:

Sodium forms ionic compounds having formulae NaCl, NaH and Na₂CO₃. Explain

Solution: Let us rewrite the formulae of the compounds of sodium showing charges on the concerned acidic and basic radicals.



It is seen that in all these compounds Na carries one positive charge. The Na[⊕] is formed from Na atom by losing one electron. $\text{Na} \rightarrow \text{Na}^{\oplus} + \text{e}^{\ominus}$

This happens because the electronic configuration of Na is [Ne]3s¹. There is only one electron in the valence shell of Na. It can easily be lost as the ionization enthalpy is low. And Na[⊕] ion so formed is stable as it has stable electronic configuration of the inert gas Ne.

Problem 8.3 : Explain the observed values 496 kJ/mol and 737 kJ/mol of the first ionization enthalpies of Na and Mg, respectively.

Solution : The electronic configuration of Na is [Ne]3s¹ and that of Mg is [Ne]3s². During the first ionization only one electron is removed from a neutral atom.

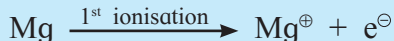

The resulting Na is isoelectronic with Ne, and therefore, is stable. That's why Na has low value of 1st ionization enthalpy. However, to form the unipositive Mg[⊕] ion energy is required to unpair these electrons in the valency shell and also remove one electron to form the ion having electronic configuration [Ne] 3s¹. It is not as stable as Na since it does not correspond to any inert gas. Therefore the first ionization enthalpy of Mg is higher than that of Na.

Problem 8.4:

What is the oxidation state of Na in Na₂O₂?

Solution: The peroxide species is represented as O₂²⁻. Any compound is electrically neutral. Therefore oxidation state of each Na is (+2/2 = +1) in Na₂O₂.

Problem 8.5 :

The atomic radii of Na, K and Mg are 186, 227 and 160 pm, respectively. Explain the differences.

Solution : Na and K both belong to the group 1. K has larger valence shell than Na. Therefore the atomic radius of K is larger than that of Na. Na and Mg belong to the same period. Therefore both have the same valence shell. But the nuclear charge of Mg is larger than that of Na. Therefore, the valence electrons of Mg are held more tightly and its atomic radius is smaller than that of Na.

The elements of group 1 and group 2 both being s-block elements, show similarity in their chemical properties. The differences are due to variation in the atomic radii, ionization enthalpies and valencies.

i. Reaction with oxygen/air

Group 1 - All the elements of group 1 rapidly lose their luster in air due to formation of a layer of oxide, on peroxide and in some cases superoxide by reaction with oxygen in air.

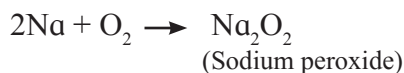
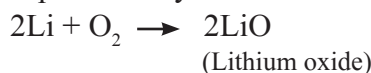
**Do you know ?**

- The reaction of Na and K with oxygen is highly exothermic and these metals catch fire when exposed to air.

- Potassium superoxide has ability to absorb carbon dioxide and give out oxygen at the same time:

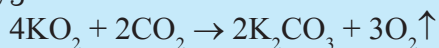

- This property of KO_2 has been made use of in breathing equipment used for mountaineers and in submarines and space.

The oxides of group 1 metals are strongly basic in nature. They dissolve in water forming aqueous solutions of strong alkali. For example

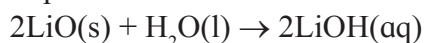

Group 2 : These metals are protected from air oxidation by an oxide film formed on their surface.

All the elements of group 2 burn when ignited in air forming MO type oxides. The product is a mixture of oxide and nitride.

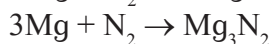
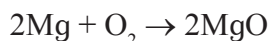

Further heating of the oxide in air results in formation of peroxide.

ii. Reaction with water

Group 1 : Lithium, sodium and potassium all float on water due to hydrogen bubbles released on reaction with water. Lithium reacts slowly but sodium and potassium react vigorously with water. Due to highly exothermic reaction sodium and potassium catch fire when put in water.



Group 2 : The elements of group 2 react with water to form metal hydroxide and hydrogen. Beryllium does not react with water. Magnesium decomposes hot water, other elements react with cold water forming metal hydroxide $\text{M}(\text{OH})_2$ and hydrogen gas.



iii. Reaction with Hydrogen

Group 1 : Alkali metals react with hydrogen at high temperature to form the corresponding metal hydrides.

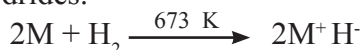

Group 2 : All the metals of group 2, except beryllium, when heated with hydrogen form MH_2 type hydrides.

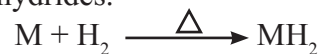

Problem 8.6 : NaCl is an ionic compound but LiCl has some covalent character, explain.

Solution: Li^{\oplus} ion has very small size, therefore the charge density on Li^{\oplus} is high. Therefore it has high tendency to distort the electron cloud around the negatively charged large chloride ion. This results in partial covalent character of the LiCl bond. Na^{\oplus} ion cannot distort the electron cloud of Cl^{\ominus} due to the bigger size of Na^{\oplus} compared to Li^{\oplus} .

iv. Reaction with Halogens

Group 1 : All the alkali metals react vigorously with halogens to produce their ionic halide salts.



Group 2: All the alkaline earth metals combine with halogens at high temperature to form halides.

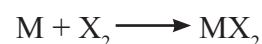

v. Reducing nature

Group 1 : The reducing power of an element is measured in terms of standard electrode potential (E^{\ominus}) corresponding to the transformation $\text{M}(\text{s}) \rightarrow \text{M}^{\oplus}(\text{aq}) + \text{e}^{\ominus}$. All the alkali metals have high negative values of E^{\ominus} indicative of their strong reducing nature, lithium is the most powerful and sodium, the least powerful in the group. (see Table 8.4)

Group 2 : All the alkaline earth metals have high negative values of standard reduction potential (E^{\ominus}). (see Table 8.5), and are strong reducing agents. However their reducing power is less than those of alkali metals.

vi Solution in liquid ammonia

Group 1 : The alkali metals are soluble in liquid ammonia giving deep blue coloured solutions which show electrical conductivity.



The ammoniated electron is responsible for the deep blue colour of these solutions. These solutions are paramagnetic and on standing liberate hydrogen slowly, resulting in formation of the metal amide. The blue colour changes to bronze and the solution becomes diamagnetic.

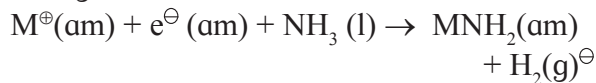

(Here (am) denotes solution in ammonia.)

Group 2 : Similar to alkali metals the alkaline earth metals are also soluble in liquid ammonia which give deep blue black coloured solutions. $M + (x + 2y) \text{NH}_3 \rightarrow [\text{M}(\text{NH}_3)_x]^{2\oplus} + 2[\text{e}(\text{NH}_3)_y]^{\ominus}$

8.2.5 Diagonal Relationship : It is expected that elements belonging to the same group exhibit similarity and gradation in their properties. The first alkali metal lithium and the first alkaline earth metal beryllium do not fulfil this expectation. Thus, lithium shows many differences when compared with the

remaining alkali metals and resembles with magnesium, the second alkaline earth metal. Likewise beryllium shows many differences with remaining alkaline earth metals and shows similarity with aluminium, the second element of the next main group (group 13). The relative placement of these elements with similar properties in the periodic table appears to be across a diagonal (see. Table 8.6) and is called diagonal relationship.

Table 8.6 : Diagonal relationship

Main Group \ Period	1	2	13
2	Li	Be	B
3	Na	Mg	Al

The table 8.7 shows some properties of lithium and magnesium which elucidate their diagonal relationship.

Table 8.7 : Resemblance between Li and Mg

Element \ Criterion	Products of reaction with air $M \xrightarrow{\text{air}} ?$	Products of thermal decomposition of carbonate $M_2\text{CO}_3/\text{MCO}_3 \xrightarrow{\Delta} ?$	Property of chloride	Formula of crystalline chloride
Li	$\text{Li}_2\text{O} + \text{Li}_3\text{N}$	$\text{Li}_2\text{O} + \text{CO}_2$	deliquescent	$\text{LiCl} \cdot 2\text{H}_2\text{O}$
Mg	$\text{MgO} + \text{Mg}_3\text{N}_2$	$\text{MgO} + \text{CO}_2$	deliquescent	$\text{MgCl}_2 \cdot 8\text{H}_2\text{O}$
Group 1 (except Li)	$\text{M}_2\text{O}/\text{M}_2\text{O}_2/\text{MO}$	No reaction	Not deliquescent	MCl
Group 2	$\text{MO} + \text{M}_3\text{N}_2$	$\text{MO} + \text{CO}_2$	deliquescent	$\text{MCl}_2 \cdot x\text{H}_2\text{O}$

In table 8.8 some properties of Be and Al are shown which indicate the diagonal relationship:

Table 8.8 : Resemblance between Be and Al

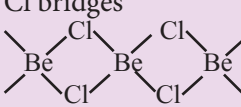
Element \ Criterion	Properties of chloride			Properties of oxide Acidic/Basic/Amphoteric
	Nature of bonding	Whether Lewis acid	Solubility in organic solvent	
Be	Covalent chain structure with Cl bridges 	BeCl ₂ is strong Lewis acid	Soluble	Amphoteric $\text{BeO} + 2\text{HCl} \rightarrow \text{BeCl}_2 + \text{H}_2\text{O}$ $\text{BeO} + 2\text{NaOH} \rightarrow \text{Na}_2\text{BeO}_2 + \text{H}_2\text{O}$

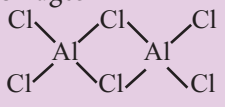
Al	Covalent dimer with Cl bridges 	AlCl_3 is strong Lewis acid	Soluble	Amphoteric $\text{Al}_2\text{O}_3 + 6\text{HCl} \rightarrow 2\text{AlCl}_3 + 3\text{H}_2\text{O}$ $\text{Al}_2\text{O}_3 + 2\text{NaOH} \rightarrow$ $2\text{NaAlO}_2 + \text{H}_2\text{O}$
Group 2	Ionic	Not Lewis acid	Insoluble	Basic $\text{MO} + \text{HCl} \rightarrow \text{MCl}_2 + \text{H}_2$ $\text{MO} + \text{NaOH} \rightarrow \text{No reaction}$
Group 13	Covalent	Lewis acid	Soluble	<i>Amphoteric</i>

The diagonal relationship between the elemental pairs belonging to different groups and periods is due to the similarity in some of their atomic properties. Thus atomic and ionic radii of Li and Mg are very similar. (see the table 8.4). In the case of Be and Al the charge to radius ratio of their ions is very similar. (Be : $\frac{2}{31}$ and Al : $\frac{3}{53.55}$)

8.2.6 Uses of elements of group 1 and group 2 Group 1

- Lithium metal is used in long-life batteries used in digital watches, calculators and computers.
- Liquid sodium has been used for heat transfer in nuclear power station.
- Potassium chloride is used as a fertilizer.
- Potassium is used in manufacturing potassium superoxide (KO_2) for oxygen generator. It is good absorbent of carbon dioxide.
- Caesium is used in photoelectric cells.

Group 2

- Beryllium is used as a moderator in nuclear reactors.
- Alloy of magnesium and aluminium is widely used as structural material and in aircrafts.
- Calcium ions are important ingredient in biological system, essential for healthy growth of bones and teeth.
- Barium sulphate is used in medicine as barium meal for intestinal x-ray.

- Radium is used in radiotherapy for cancer treatment.

8.2.7. Biological importance of elements of group 1 and group 2

Group 1

- Sodium ion is present as the largest supply in all extracellular fluids. These fluids provide medium for transporting nutrients to the cells.
- The concentration of sodium ion in extracellular fluids regulates the flow of water across the membrane.
- Sodium ions participate in the transmission of nerve signals.
- Potassium ions are the most abundant ions within cells. These are required for maximum efficiency in the synthesis of proteins and also in oxidation of glucose.

Group 2

- $\text{Mg}^{2\oplus}$ ions are important part of chlorophyll in green plants.
- $\text{Mg}^{2\oplus}$ ions play an important role in the breakage of glucose and fat molecule, in synthesis of protein with enzyme, in regulation of cholesterol level.
- $\text{Ca}^{2\oplus}$ ions are important for bones and teeth as apatite [$\text{Ca}_3(\text{PO}_4)_2$]
- $\text{Ca}^{2\oplus}$ ions play important role in blood clotting.
- $\text{Ca}^{2\oplus}$ ions are required for contraction and stretching of muscles.
- $\text{Ca}^{2\oplus}$ ions are also required to maintain the regular beating of heart.

Problem 8.7 : Magnesium strip slowly tarnishes on keeping in air but metallic calcium is readily attacked by air. Explain.

Solution: Mg and Ca belong to group 2, but periods 2 and 3, respectively. During the reaction with air the metallic Mg and Ca lose their valence electrons. The tendency to lose valence electron is the metallic character, which increases down the group. Thus, calcium has higher metallic character, greater tendency to lose valence electron and lower ionization enthalpy than magnesium. Therefore Mg reacts slowly with air, forming a thin film of oxide, resulting into tarnishing, whereas Ca reacts readily at room temperature with oxygen and nitrogen in the air.

8.3 Some important compounds of elements of s-block

In this section we consider five important compounds of s-block elements with reference to their preparation, properties and uses.

8.3.1. Sodium Carbonate (washing soda) $\text{Na}_2\text{CO}_3 \cdot 10\text{H}_2\text{O}$

Preparation: Sodium Carbonate is commercially prepared by **Solvay process**. In the **first stage** of process CO_2 is passed into a concentrated solution of NaCl which is saturated with NH_3 . Crystals of sodium bicarbonate separate as a result of the following reactions.

Reactions in the first stage:

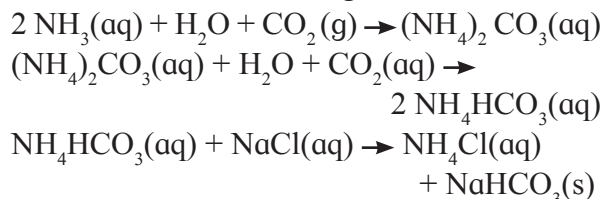

Sodium bicarbonate has low solubility, and therefore its crystals precipitate out which are formed as a result of the double decomposition reaction between ammonium bicarbonate and sodium chloride.

In the **second stage** the separated crystals of sodium bicarbonate are heated to obtain sodium carbonate.

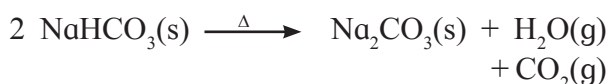

In this process the **recovery of ammonia** is done by treating the solution of NH_4Cl obtained with slaked lime, $\text{Ca}(\text{OH})_2$. The byproduct of this reaction is calcium chloride.

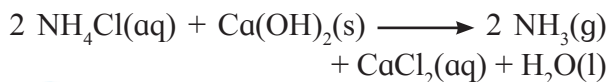

Do you know ?

Potassium carbonate can not be prepared by Solvay process because potassium hydrogen carbonate is highly water soluble and cannot be precipitated by reaction with potassium chloride.

Properties : Sodium carbonate (washing soda) is a white crystalline solid having the formula $\text{Na}_2\text{CO}_3 \cdot 10\text{H}_2\text{O}$. It is highly soluble in water. On heating the decahydrate loses water molecules to form monohydrate. On heating above 373 K temperature monohydrate further loses water and changes into white anhydrous powder called soda-ash.

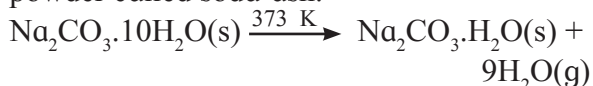

Aqueous solution of sodium carbonate is alkaline because of its hydrolysis by the following reaction:

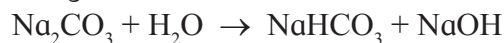

Uses

- The alkaline properties give sodium carbonate an emulsifying effect on grease and dirt. It is used as cleaning material.
- It is used to make hard water soft (as a water softener), as insoluble it precipitates out the soluble calcium and magnesium salts in hard water as carbonates. For example :

$$\text{Ca}(\text{HCO}_3)_2(\text{aq}) + \text{Na}_2\text{CO}_3(\text{aq}) \rightarrow \text{CaCO}_3(\text{s}) + 2\text{NaHCO}_3(\text{aq})$$
- It is used for commercial production of soap and caustic soda.
- It is an important laboratory reagent.

8.3.2 Sodium hydroxide (caustic soda) NaOH

Preparation : Sodium hydroxide is commercially obtained by the electrolysis of sodium chloride. Brine solution is subjected to electrolysis in Castner-Kellner cell. Mercury is used as cathode and carbon rod as anode. Metallic sodium liberated at the cathode forms sodium amalgam. Chlorine gas is evolved at the anode.

Cathode reaction: $\text{Na}^{\oplus} + \text{e}^{\ominus} \xrightarrow{\text{Hg}} \text{Na-amalgam}$

Anode reaction: $\text{Cl}^{\ominus} \longrightarrow \frac{1}{2} \text{Cl}_2 + \text{e}^{\ominus}$

Sodium hydroxide is obtained by treating sodium amalgam with water, when hydrogen gas is liberated.



Properties : Sodium hydroxide is a white deliquescent solid, having melting point 591 K. It is highly water soluble and gives a strongly alkaline solution. The surface of the solution absorbs atmospheric CO_2 to form Na_2CO_3 .

Uses

- Sodium hydroxide is used in purification of bauxite (the aluminium ore).
- It is used in commercial production of soap, paper, artificial silk and many chemicals.
- It is used for mercerising cotton fabrics.
- It is used in petroleum refining.
- It is an important laboratory reagent.

8.3.3 Calcium Carbonate (CaCO_3)

Calcium carbonate is found in nature as chalk, lime stone, marble.

Preparation

i. When carbon dioxide is bubbled through solution of calcium hydroxide (slaked lime) water insoluble solid calcium carbonate is formed.

$\text{Ca}(\text{OH})_2(\text{aq}) + \text{CO}_2(\text{g}) \longrightarrow \text{CaCO}_3(\text{s}) + \text{H}_2\text{O}(\text{l})$
Excess carbon dioxide transforms the precipitate of CaCO_3 into water soluble calcium bicarbonate and therefore has to be avoided.

ii. When solution of calcium chloride is added to a solution of sodium carbonate, calcium carbonate is formed as precipitate.

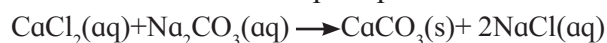

Properties

Calcium carbonate is soft, light, white powder. It is practically water insoluble. On heating to 1200 K calcium carbonate decomposes into calcium oxide and carbon dioxide.

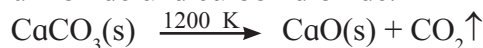

It reacts with dilute acids to give the corresponding calcium salt and carbon dioxide.



Uses:

- Calcium carbonate in the form of marble is used as building material.
- Calcium carbonate is used in the manufacture of quicklime (CaO) which is the major ingredient of cement.
- A mixture of CaCO_3 and MgCO_3 is used as flux in the extraction of metals from ores.
- It is required for the manufacture of high quality paper.
- It is an important ingredient in toothpaste, chewing gum, dietary supplements of calcium and filler in cosmetics.

8.3.4 Hydrogen peroxide (H_2O_2) : Hydrogen peroxide is a low cost clean and mild oxidising agent. A 30% aqueous solution hydrogen peroxide is commercially available.

Preparation :

i. Hydrated barium peroxide is treated with ice cold dilute sulphuric acid. The precipitate of barium sulphate formed is filtered off to get hydrogen peroxide solution.

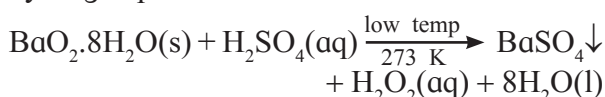

ii. Small quantity of sodium peroxide is added to ice-cold solution of dilute sulphuric acid with stirring gives hydrogen peroxide (Merck process).

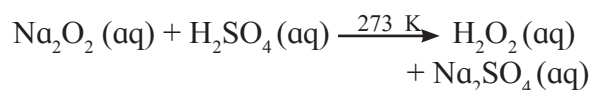

iii. A 50 % solution of sulphuric acid is subjected to an electrolytic oxidation to form peroxydisulphuric acid at anode.

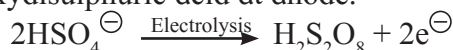

Hydrolysis of the peroxydisulphuric acid yields hydrogen peroxide.

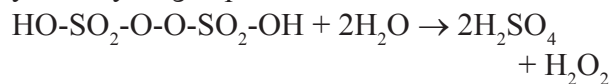

This method can be extended to laboratory preparation of D_2O_2

iv. Industrially hydrogen peroxide is prepared by air-oxidation of 2-ethylanthraquinol.

The 2-ethylanthraquinol is regenerated by catalytic hydrogenation of 2-ethylanthraquinone.

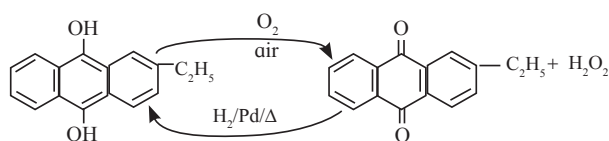
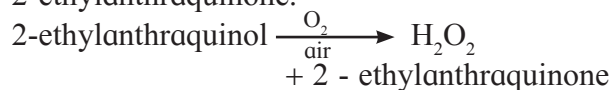

Properties

- Pure H_2O_2 is a very pale blue coloured liquid, having b.p. 272.4 K.
- H_2O_2 is miscible in water and forms a hydrate ($\text{H}_2\text{O}_2 \cdot \text{H}_2\text{O}$)
- Strength of aqueous solution of H_2O_2 is expressed in 'volume' units. The commercially marketed 30% (by mass) solution of H_2O_2 has volume strength of 100 volume. It means that 1 mL of 30% solution of H_2O_2 will give 100 mL oxygen at STP.
- H_2O_2 acts as a mild oxidising as well as reducing agent.

a. Oxidising action of H_2O_2 in acidic medium

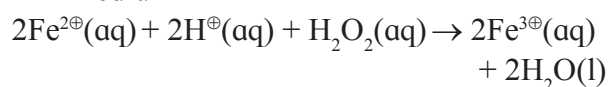

b. Reducing action of H_2O_2 in acidic medium

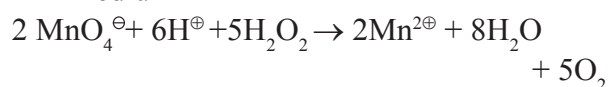

Uses

- Hydrogen peroxide is used as mouthwash, germicide, mild antiseptic, preservative for milk and wine and bleaching agent for soft materials due to its mild oxidising property.
- Hydrogen peroxide, due to its reducing property, is used as an antichlor to remove

excess chlorine from fabrics which have been bleached by chlorine.

iii. Now a days it is also used in environmental chemistry for pollution control, restoration of aerobic condition to sewage water.

Problem 8.8 : Calculate % (by mass) of a H_2O_2 solution which is 45.4 volume.

Solution: 45.4 Volume H_2O_2 solution means 1L of this solution will give 45.4 L O_2 at STP

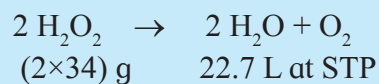

Thus, 22.7 L O_2 at STP is produced by 68 g H_2O_2

$$\therefore 45.4 \text{ L } \text{O}_2 \text{ at STP is produced by } \frac{68 \times 45.4}{22.7} = 136 \text{ g } \text{H}_2\text{O}_2$$

$$\therefore \text{Strength this } \text{H}_2\text{O}_2 \text{ solution} = 136 \text{ g/L}$$

$$= \frac{136 \text{ g } \text{H}_2\text{O}_2}{1000 \text{ g water}} = 13.6\% \text{ (by mass)}$$

8.3.5 Lithium aluminium hydride (LiAlH_4)

Lithium aluminium hydride is commonly abbreviated as LAH. It has chemical formula LiAlH_4 .

Preparation : Lithium hydride is treated with aluminium chloride to give lithium aluminium hydride

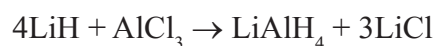

Properties: Lithium aluminium hydride is a colourless solid. It reacts violently with water and even atmospheric moisture.

Uses

(i) LAH is a source of hydride and therefore used as reducing agent in organic synthesis.

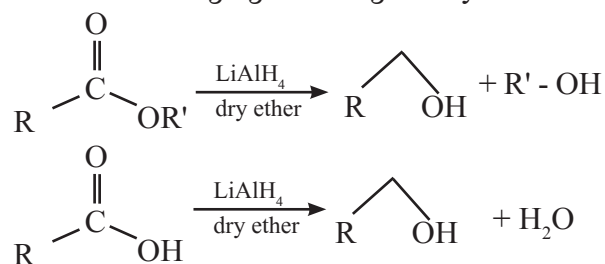

(ii) LAH is useful to prepare PH_3 (phosphine)

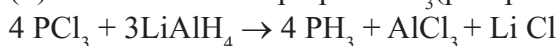



Exercises

1. Explain the following

- Hydrogen shows similarity with alkali metals as well as halogens.
- Standard reduction potential of alkali metals have high negative values.
- Alkaline earth metals have low values of electronegativity; which decrease down the group.
- Sodium dissolves in liquid ammonia to form a solution which shows electrical conductivity.
- BeCl_2 is covalent while MgCl_2 is ionic.
- Lithium floats on water while sodium floats and catches fire when put in water.

2. Write balanced chemical equations for the following.

- CO_2 is passed into concentrated solution of NaCl , which is saturated with NH_3 .
- A 50% solution of sulphuric acid is subjected to electrolyte oxidation and the product is hydrolysed.
- Magnesium is heated in air.
- Beryllium oxide is treated separately with aqueous HCl and aqueous NaOH solutions.

3. Answer the following questions

- Describe the diagonal relationship between Li and Mg with the help of two illustrative properties.
- Outline the industrial production of dihydrogen from steam. Also write the chemical reaction involved.
- A water sample, which did not give lather with soap, was found to contain $\text{Ca}(\text{HCO}_3)_2$ and $\text{Mg}(\text{HCO}_3)_2$. Which chemical will make this water give lather with soap? Explain with the help of chemical reactions.
- Name the isotopes of hydrogen. Write their atomic composition schematically and explain which of these is radioactive?

4. Name the following

- Alkali metal with smallest atom.
- The most abundant element in the universe.
- Radioactive alkali metal.
- Ions having high concentration in cell sap.
- A compound having hydrogen, aluminium and lithium as its constituent elements.

5. Choose the correct option.

- The unstable isotope of hydrogen is
a. H-1 b. H-2
c. H-3 d. all the three
- Identify the odd one.
a. Rb b. Ra
c. Sr d. Be
- Which of the following is Lewis acid?
a. BaCl_2 b. KCl
c. BeCl_2 d. LiCl
- What happens when crystalline Na_2CO_3 is heated?
a. releases CO_2
b. loses H_2O
c. decomposes in NaHCO_3
d. no change taken place.



Activity :

- Collect the information of preparation of dihydrogen and make a chart.
- Find out the s block elements compounds importance/uses.

9. Elements of group 13, 14 and 15



Can you recall?

If the valence shell electronic configuration of an element is $3s^23p^1$ in which block of periodic table is it placed ?

9.1 Introduction : You have learnt in Chapter 7 that in the p-block elements the differentiating electron (the last filling electron) enters the outermost p orbital. You also know that maximum six electrons can be accommodated in p-subshell (or three p orbitals). This gives rise to six groups, group 13 to 18, in the p-block. The p-block elements show greater variation in the properties than 's' block, which you learnt in the previous chapter. In this chapter you are going to study the elements of the groups 13, 14 and 15 in some details.

The elements boron (${}_5\text{B}$), aluminium (${}_{13}\text{Al}$), gallium (${}_{31}\text{Ga}$), indium (${}_{49}\text{In}$) and thallium (${}_{81}\text{Tl}$) constitute the group 13, called the boron family. The elements carbon (${}_6\text{C}$), silicon (${}_{14}\text{Si}$), germanium (${}_{32}\text{Ge}$), tin (${}_{50}\text{Sn}$)

and lead (${}_{82}\text{Pb}$) form the group 14 called the carbon family. The elements nitrogen (${}_7\text{N}$), phosphorous (${}_{15}\text{P}$), arsenic (${}_{33}\text{As}$), antimony (${}_{51}\text{Sb}$) and bismuth (${}_{83}\text{Bi}$) belong to group 15 of the periodic table called the nitrogen family.

9.2 Electronic configuration of elements of groups 13, 14 and 15

The general outer electronic configuration of the group 13 elements is ns^2np^1 , those of the group 14 elements is ns^2np^2 while the group 15 elements are shown as ns^2np^3 . These electronic configurations differ from their nearest inert gas by 3 or 4 electrons. These elements do not occur in free monoatomic state and found as compounds with other elements or as polyatomic molecules (such as N_2 , P_4 , C_{60}) or polyatomic covalent arrays (such as graphite, diamond). Table 9.1 shows the condensed electronic configuration of the elements of group 13, group 14 and group 15.

Table 9.1 : condensed electronic configuration of elements of groups 13, 14 and 15

Group 13 (Boron family)		Group 14 (Carbon family)		Group 15 (Nitrogen family)	
Element	Condensed electronic configuration	Element	Condensed electronic configuration	Element	Condensed electronic configuration
${}_5\text{B}$	$[\text{He}]2s^22p^1$	${}_6\text{C}$	$[\text{He}]2s^22p^2$	${}_7\text{N}$	$[\text{He}]2s^22p^3$
${}_{13}\text{Al}$	$[\text{Ne}]3s^23p^1$	${}_{14}\text{Si}$	$[\text{Ne}]3s^23p^2$	${}_{15}\text{P}$	$[\text{Ne}]3s^23p^3$
${}_{31}\text{Ga}$	$[\text{Ar}]3d^{10}4s^24p^1$	${}_{32}\text{Ge}$	$[\text{Ar}]3d^{10}4s^24p^2$	${}_{33}\text{As}$	$[\text{Ar}]3d^{10}4s^24p^3$
${}_{49}\text{In}$	$[\text{Kr}]4d^{10}5s^25p^1$	${}_{50}\text{Sn}$	$[\text{Kr}]4d^{10}5s^25p^2$	${}_{51}\text{Sb}$	$[\text{Kr}]4d^{10}5s^25p^3$
${}_{81}\text{Tl}$	$[\text{Xe}]4f^{14}5d^{10}6s^26p^1$	${}_{82}\text{Pb}$	$[\text{Xe}]4f^{14}5d^{10}6s^26p^2$	${}_{83}\text{Bi}$	$[\text{Xe}]4f^{14}5d^{10}6s^26p^3$

Problem 9.1 : Atomic numbers of the group 13 elements are in the order $\text{B} < \text{Al} < \text{Ga} < \text{In} < \text{Tl}$. Arrange these elements in increasing order of ionic radii of $\text{M}^{3\oplus}$.

Solution : The given elements are in an increasing order of atomic number. As we go down the group 13, their general outer electronic configuration is ns^2np^1 . $\text{M}^{3\oplus}$ is formed by removal of three electrons from the outermost shell 'n'. In the $\text{M}^{3\oplus}$ the 'n-1' shell becomes the outermost. Size of the added 'n-1' shell increases down the group. Therefore the ionic radii of $\text{M}^{3\oplus}$ also increase down the group as follows :

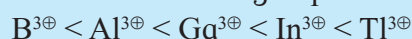

Problems 9.2 Why the atomic radius of Gallium is less than that of aluminium ?

Solution : Atomic radius increases down the group due to added new shell. 'Al' does not have 'd' electrons. As we go from Al down to 'Ga' the nuclear charge increase by 18 units. Out of the 18 electrons added, 10 electrons are in the inner 3d subshell. 'd' Electrons offer poor shielding effect. Therefore, the effects of attraction due to increased nuclear charge is experienced prominently by the outer electrons of 'Ga' and thus its atomic radius becomes smaller than that of 'Al'.

9.3 Trends in atomic and physical properties of elements of groups 13, 14 and 15. : The elements of group 13 show a wide variation in properties. In group 13 boron is a metalloid. It is glossy and hard solid like metal but a poor electrical conductor (like nonmetals). The other elements in this group are fairly reactive metals. Aluminium is the third most abundant element in the earth's crust. Some physical and atomic properties of group 13 elements are given in Table 9.2

Table 9.2 : Physical properties of elements of group 13

Element	Atomic number	Atomic mass	Atomic radius (pm)	Ionic radius (pm) $M^{3\oplus}$	Ionization enthalpy (kJ mol ⁻¹)			Electronegativity	Density (g/cm ³)	Melting point (K)	Boiling point (K)
					1 st	2 nd	3 rd				
B	5	10.81	88	27	801	2427	3659	2.0	2.35	24.53	3923
Al	13	26.98	143	53.5	577	1816	2744	1.5	2.70	933	2740
Ga	31	69.72	135	62.0	579	1979	2962	1.6	5.90	303	2676
In	49	114.82	167	80.0	558	1820	2704	1.7	7.31	430	2353
Tl	81	204.38	170	88.5	589	1971	2877	1.8	11.85	576	1730

Problem 9.3 : The values of the first ionization enthalpy of Al, Si and P are 577, 786 and 1012 kJmol⁻¹ respectively. Explain the observed trend.

Solution : The trend shows increasing first ionization enthalpy from Al to Si to P. Al, Si and P belong to 13 period in the periodic table. They have same valence shell. Due to the increased nuclear charge electrons in the valence shell are more tightly held by the nucleus as we go from Al to Si to P. Therefore more energy is required to remove an electron from its outermost shell.

Table 9.3 enlists atomic and physical properties of the elements of carbon family (which is the group 14). In this group all the three traditional types of elements are present. Carbon is a nonmetal, silicon is a metalloid

which is brittle like nonmetal, it is hard and has metallic luster. Germanium is also brittle but hard and lustrous metalloid. Tin or lead down the group are corrosion resistant and moderately reactive.

Table 9.3 : Some physical and atomic properties of group 14 elements

Element	Atomic number	Atomic mass	Atomic radius (pm)	Ionic radius (pm) $M^{3\oplus}$	Ionization enthalpy (kJ mol ⁻¹)				Electro-negativity	Density (g/cm ³)	Melting point (K)	Boiling point (K)
					1 st	2 nd	3 rd	4 th				
C	6	12.01	77		1086	2352	4620	6220	2.5	3.51	4373	
Si	14	28.09	118	40	786	1577	3228	4354	1.8	2.34	1693	3550
Ge	32	72.60	122	53	761	1537	3300	4400	1.8	5.32	1218	3123
Sn	50	118.71	140	69	708	1411	2942	3929	1.8	7.26	505	2896
Pb	82	207.2	146	78	715	1450	3081	4082	1.9	11.34	600	2024

Table 9.4 : Some physical and atomic properties of group 15 elements

Element	Atomic number	Atomic mass	Atomic radius (pm)	Ionic radius (pm)	Ionization enthalpy (kJ mol ⁻¹)			Electronegativity	Density (g/cm ³)	Melting point (K)	Boiling point (K)
					1 st	2 nd	3 rd				
N	7	14.01	70	171 (M ^{3⊕})	1402	2856	4577	3.0	0.879	6.3	77.2
P	15	30.97	110	212 (M ^{3⊕})	1012	1903	2910	2.1	1.823	317	554
As	33	74.92	121	222(M ^{3⊕})	947	1798	2736	2.0	5.778	1089	-
Sb	51	121.75	141	76 (M ^{3⊕})	834	1595	2443	1.9	6.697	904	1860
Bi	83	208.98	148	103(M ^{3⊕})	703	1610	2466	1.9	9.808	544	1837

Group 15 is the nitrogen family. Table 9.4 shows atomic and physical properties of the elements of group 15. This group also include the three traditional types of elements: The gaseous nitrogen and brittle phosphorous are nonmetals. Arsenic and antimony are metalloids while bismuth is moderately reactive metal.

9.4 Chemical properties of the elements of the groups 13,14 and 15

9.4.1 Oxidation state : Oxidation state is the primary chemical property of all elements. The highest oxidation state exhibited by the p-block elements is equal to total number of

valence electrons (sum of s- electrons and p-electrons). This is sometimes called the group oxidation state. In boron, carbon and nitrogen families the group oxidation state is the most stable oxidation state for the lighter elements. Besides, the elements of groups 13, 14 and 15 exhibit other oxidation states which are lower than the group oxidation state by two units. The lower oxidation states become increasingly stable as we move down to heavier elements in the groups. Table 9.5 shows various oxidation states exhibited by elements belonging to these groups.



Remember

The increased stability of the oxidation state lowered by 2 units than the group oxidation state in heavier p-block elements is due to **inert pair effect**. In these elements, the two s-electrons are involved less readily in chemical reactions. This is because the s-electrons of valence shell in p-block elements experience poor shielding than valence p- electron, due to ten inner d-electrons.

Table 9.5 : oxidation states of the elements of groups 13, 14 and 15

Group	13	14	15
Outer electronic configuration	$ns^2 np^1$	$ns^2 np^2$	$ns^2 np^3$
Group oxidation state	+3	+4	+5
Other oxidation states	+1	+2, -4	+3, -3
Examples of stable compounds	BF ₃ , AlCl ₃ , GaCl ₃ , InCl ₃ , TlBr	CH ₄ , CO ₂ , CCl ₄ , SiCl ₄ , GeCl ₄ , SnCl ₂ , PbCl ₂	N ₂ O ₅ , NH ₃ , NF ₃ , PH ₃ , PCl ₅ , AsH ₃ , SbH ₃ , SbCl ₃ , BiCl ₃

Problem 9.4 : Why Tl^{⊕1} ion is more stable than Tl^{⊕3} ?

Solution : Tl is a heavy element which belongs to group 13 of the p-block. The common oxidation state for this group is 3. In p-block, the lower oxidation state is more stable for heavier elements due to inert pair effect . Therefore, Tl^{⊕1} ion is more stable than Tl^{⊕3} ion.

9.4.2 Bonding in compounds of group 13, 14 and 15 elements :

The lighter elements in groups 13, 14 and 15 have small atomic radii and high ionization enthalpy values. They form covalent bonds with other atoms by overlapping of valence shell orbitals. As we move down the group, the ionization enthalpies are lowered. The atomic radii increase since the valence shell orbitals are more diffused. The heavier elements in these group tend to form ionic bonds. The first member of these groups belongs to second period and do not have d orbitals. B, C and N cannot expand their octet. The subsequent elements in the group possess vacant d orbital in their valence shell, which can expand their octet forming a variety of compounds.

9.4.3 Reactivity towards air/oxygen

a. Group 13 elements : Elements of group 13 on heating with air or oxygen produce oxide of type E_2O_3 (where E = element)

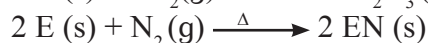
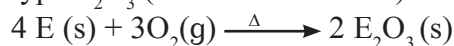

b. Group 14 elements : The elements of group 14 on heating in air or oxygen form oxide of the type EO and EO_2 in accordance with the stable oxidation state and availability of oxygen.

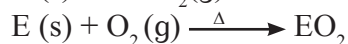

c. Group 15 elements : The elements of group 15 on heating in air or oxygen forms two types of oxide E_2O_3 and E_2O_5 .

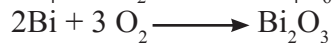
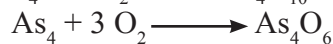
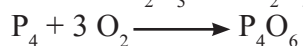

Increase in metallic character down all these groups 13, 14 and 15 reflects their oxides which gradually vary from acidic through amphoteric to basic. (see Table 9.6)

The nature of stable oxides from groups 13, 14 and 15 are given in Table 9.6.

Table 9.6 : Nature of stable oxides of groups 13, 14 and 15 elements

Group	Element	Oxide	Nature
13	B	B_2O_3	Acidic
	Al	Al_2O_3	Amphoteric
	Ga	Ga_2O_3	Amphoteric
	In	In_2O_3	Basic
	Tl	Tl_2O_3	Basic
14	C	CO_2	Acidic
	Si	SiO_2	Acidic
	Ge	GeO_2	Acidic
	Sn	SnO_2	Amphoteric
	Pb	PbO_2	Amphoteric
15	N	N_2O_5	Acidic
	P	P_2O_5	Acidic
	As	As_4O_6	Amphoteric
	Sb	Sb_2O_3	Amphoteric
	Bi	Bi_2O_3	Basic



Do you know ?

Boron nitride is also called inorganic graphite.

9.4.4 Reaction with water

Most of the elements of groups 13,14 and 15 are **unaffected by water**. Aluminium reacts with water on heating and forms hydroxide while tin reacts with steam to form oxide.



Lead is unaffected by water, due to formation of a protective film of oxide.

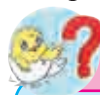

Do you know ?

Phosphorous stored under water because it catches fire when exposed to air.

9.4.4 Reaction with halogens

All the elements of **group 13** react directly with halogens to form trihalides (EX_3). Thallium is an exception which forms mono halides (TIX)

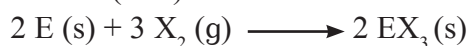

All the elements of **group 14** (except carbon) react directly with halogens to form

tetrahalides (EX_4). The heavy elements Ge and Pb form dihalides as well. Stability of dihalides increases down the group. (Refer to 9.3.1, inert pair effect). The ionic character of halides also increases steadily down the group.

Problem 9.5 : $GeCl_4$ is more stable than $GeCl_2$ while $PbCl_2$ is more stable than $PbCl_4$. Explain.

Solution : Ge and Pb are the 4th and 5th period elements down the group 14. The group oxidation state of group 14 is 4 and the stability of other oxidation state, lower by 2 units, increases down the group due to inert pair effect. The stability of the oxidation state 2 is more in Pb than in Ge.

Elements of the **group 15** reacts with halogens to form two series of halides: EX_3 and EX_5 . The pentahalides possess more covalent character due to availability of vacant d orbitals of the valence shell for bonding. (Nitrogen being second period element, does not have d orbitals in its valence shell, and therefore, does not form pentahalides). Trihalides of the group 15 elements are predominantly covalent except BiF_3 . The only stable halide of nitrogen is NF_3 .

Problem 9.6 : Nitrogen does not form NCl_5 or NF_5 but phosphorous can. Explain.

Solution : Phosphorous and other members of the group can make use of d-orbitals in their bonding and thus compounds MX_3 , as well MX_5 are formed Nitrogen can not form NCl_5 or NF_5 since it is void of d-orbitals in its second shell.

9.5 Catenation : The property of self linking of atoms of an element by covalent bonds to form chains and rings is called catenation. The catenation tendency of an element depends upon the strength of the bond formed.

Among the group 14 elements, carbon shows the maximum tendency for catenation because of the stronger C - C bond (348 kJ mol^{-1})

The order of catenation of group 14 elements is $C \gg Si > Ge = Sn$. Lead does not show catenation. This can be clearly seen from the bond enthalpy values.

Bond	Bond enthalpy (kJmol^{-1})
C - C	348
Si - Si	297
Ge - Ge	260
Sn - Sn	240



Can you recall?

What is common between diamond and graphite?

9.6 Allotropy : When a solid element exists in different crystalline forms with different physical properties such as colour, density, melting point, etc. the phenomenon is called allotropy and individual crystalline forms are called allotropes. Diamond and graphite are well known allotropes of carbon. Fullerenes, graphene and carbon nanotubes are other allotropes of carbon. Elements such as boron, bismuth, silicon, etc. of group 13, 14, and 15 exhibit allotropy. In this chapter we are going to look at some aspects of allotropes of carbon and phosphorous .

9.6.1 Allotropes of Carbon :

a. Diamond : In diamond each carbon atom is linked to four other carbon atoms (via. sp^3 hybrid orbitals) in tetrahedral manner.

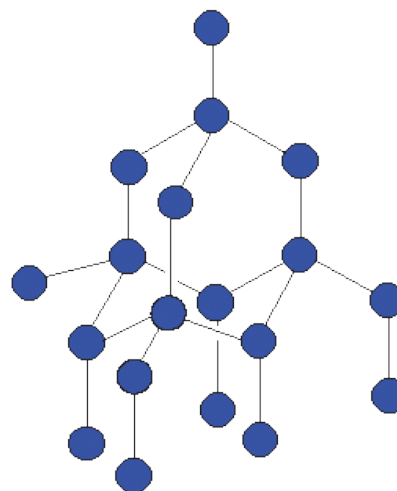

Fig 9.1 Structure of diamond

The C-C bond distance is 154 pm. The tetrahedra are linked together forming a three dimensional network structure (Fig. 9.1) involving strong C-C single bonds. Thus diamond is the hardest natural substance with abnormally high melting point (3930 °C). Diamond is bad conductor of electricity.

Uses : Diamond is used

- for cutting glass and in drilling tools.
- for making dies for drawing thin wire from metal.
- for making jewellery.

b. Graphite : Graphite is composed of layers of two dimensional sheets of carbon atoms (Fig. 9.2) each being made up of hexagonal net of sp^2 carbons bonded to three neighbours forming three bonds. The fourth electron in the unhybrid p-orbital of each carbon is shared by all carbon atoms. These π electrons are delocalised over the whole layer. The C-C bond length in graphite is 141.5 pm. The individual layers are held by weak van der Waals forces and separated by 335 pm. The graphite is soft and slippery.

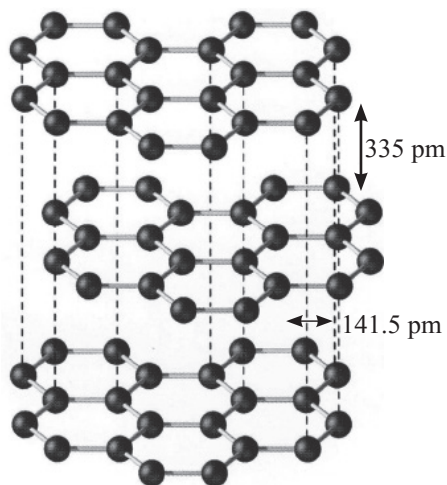

Fig 9.2 Structure of graphite



Remember

Graphite is thermodynamically most stable form (allotrope) of carbon.

c. Fullerene : Fullerenes are allotropes of carbon in which carbon molecules are linked by a definite numbers of carbon atoms, for example as in C_{60} . Fullerenes are produced,

when an electric arc is struck between the graphite electrodes in an inert atmosphere of argon or helium. The soot formed contains significant amount of C_{60} fullerene and smaller amounts of other fullerenes C_{32} , C_{50} , C_{70} and C_{84} .

C_{60} has a shape like soccer ball and called Buckminster fullerene or bucky ball. (Fig. 9.3) It contains twenty hexagonal and twelve pentagonal fused rings of carbons.

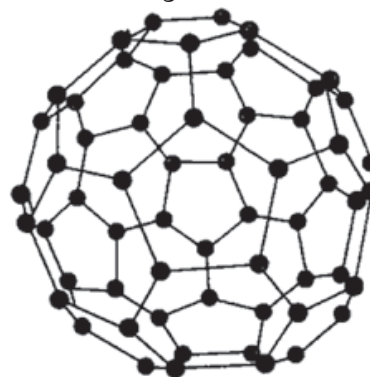

Fig. 9.3 Buckminsterfullerene

Unlike diamond and graphite, the C_{60} fullerene structure exhibit separations between the neighbouring carbons as 143.5 pm and 138.3 pm. Fullerenes are covalent and soluble in organic solvents. Fullerene C_{60} reacts with group 1 metals forming solids such as K_3C_{60} . The compound K_3C_{60} behaves as a superconductor below 18 K, which means that it carries electric current with zero resistance.

d. Carbon nanotubes : Carbon nanotubes are cylindrical in shape, consisting of rolled-up graphite sheet (Fig 9.4). Nanotubes can be single-walled (SWNTs) with a diameter of less than 1 nm or multi-walled (MWNTs) with

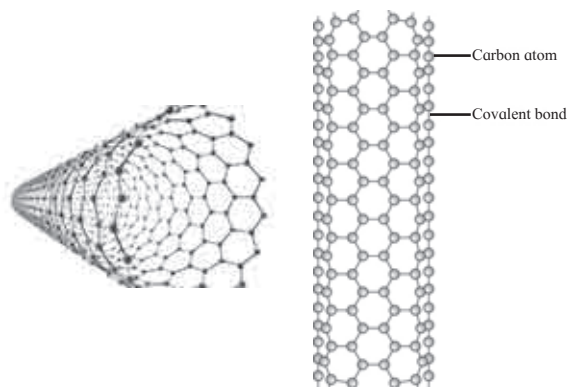

Fig. 9.4 Carbon nanotubes

diameter reaching more than 100 nm. Their length range from several micro meters to millimeters.

Carbon nanotubes are robust. They can be bent, and when released, they will spring back to the original shape.

Carbon nanotubes have high electrical or heat conductivities and highest strength - to - weight ratio for any known material to date. The researchers of NASA are combining carbon nanotubes with other materials into composites those can be used to build light weight space craft.

e. Graphene : Isolated layer of graphite is called graphene (Fig. 9.5). Graphene sheet is a two dimensional solid. Graphene has unique electronic properties.

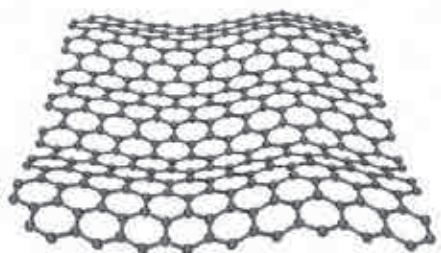

Fig. 9.5 Graphene



Do you know ?

The discovery of graphene was awarded with the Nobel prize to Geim and Novoselov (2010).

9.6.2 Allotropes of phosphorus : Phosphorus is found in different allotropic forms, the important ones being white and red phosphorus.

a. White (yellow) phosphorus : White (yellow) phosphorus consists of discrete tetrahedral P_4 molecules. The P-P-P bond angle is 60° .

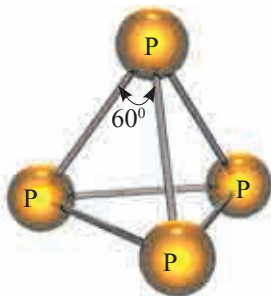

White phosphorus is less stable and hence more reactive, because of angular strain in the P_4 molecule.

- It is translucent white waxy solid.
- It glows in dark (chemiluminescence).
- It is insoluble in water but dissolves in boiling NaOH solution.
- It is poisonous.

b. Red phosphorus : Red phosphorus consists of chains of P_4 tetrahedra linked together by covalent bonds. Thus it is polymeric in nature.

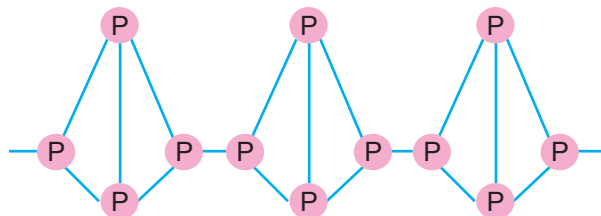

- It is stable and less reactive.
- It is odourless. It possesses iron grey lustre
- It does not glow in dark.
- It is insoluble in water.
- It is non poisonous.



Remember

Red phosphorus is prepared by heating white phosphorus at 573 K in an inert atmosphere.

9.7 Molecular structures of some important compounds of the group 13, 14 and 15 elements



Can you recall?

- Which element from the following pairs has higher ionization enthalpy? B and Tl, N and Bi
- Does Boron form covalent compound or ionic ?

You have seen in section 9.2 that lighter elements of groups 13, 14 and 15 have higher ionization enthalpy and because of smaller atomic radius do not form cation readily. These elements form covalent compounds. Covalent molecules have definite shape described with the help of bond lengths and bond angles. Inorganic molecules are often represented by molecular formulae indicating their elemental composition.

In the case of covalent inorganic molecules, the reactivity is better understood from their structures. In this section we will consider molecular structures of common compounds of elements of groups 13,14 and 15.

9.7.1 Boron trichloride (BCl₃) : Boron trichloride (BCl₃) is covalent. Here boron atom is sp² hybridised having one vacant unhybridised p orbital. B in BCl₃ has incomplete octet. The BCl₃ is nonpolar trigonal planar molecule as shown.

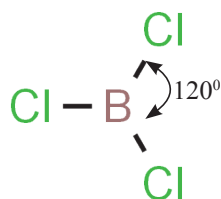

9.7.2 Aluminium Chloride (AlCl₃) :

Aluminium atom in aluminium chloride is sp² hybridised, with one vacant unhybrid p orbital. Aluminium Chloride (AlCl₃) exists as the dimer (Al₂Cl₆) formed by overlap of vacant 3d orbital of Al with a lone pair of electrons of Cl.

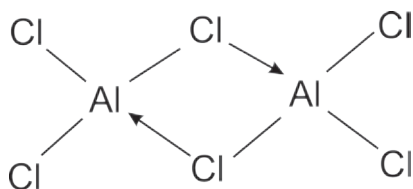

9.7.3 Orthoboric acid / boric acid (H₃BO₃) :

The orthoboric acid has central boron atom bound to three -OH groups. The solid orthoboric acid has layered crystal structure in which trigonal planar B(OH)₃ units are joined together by hydrogen bonds.

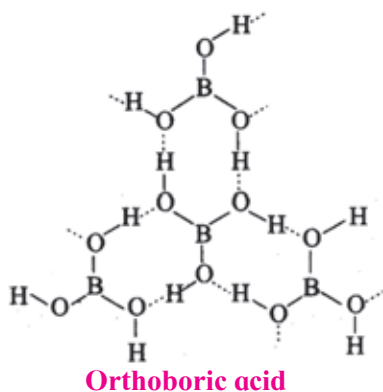

9.7.4 Diborane (B₂H₆) : Boron has only three valence electron. In diborane each boron atom is sp³ hybridized. Three of such hybrid orbitals are half filled, the fourth sp³ hybrid orbital being vacant.

The two half filled sp³ hybrid orbitals of each B atom overlap with 1s orbitals of two H atoms and form four B-H covalent bonds. Hydrogen atoms are located at the terminal. Besides, there are **2-centre - 2-electron** bonds where '1s' orbital of each of the remaining two H atoms simultaneously overlap with half filled hybrid orbital of one B atom and the vacant hybrid orbital of the other B atom. This type of overlap produces two three centred - (3 e - 2 e) two electron bonds or banana bonds. Hydrogen atoms involved in (3 e - 2 e) bonds are the bridging H- atoms. In diborane two B atoms and four terminal H atoms lie in one plane, while the two bridging H atoms lie symmetrically above and below this plane.

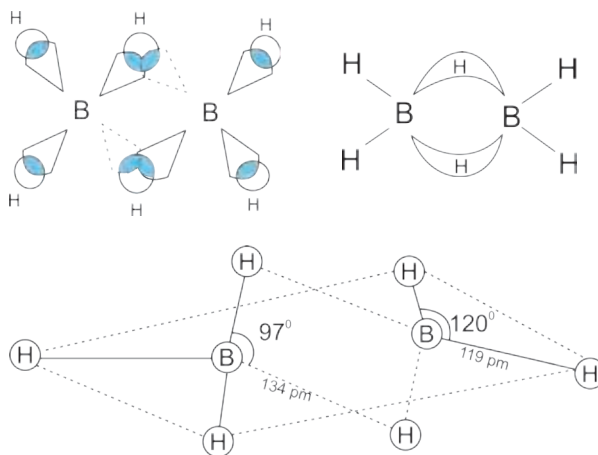

Bonding and structure of diborane

9.7.5 Silicon dioxide (SiO₂) : Silicon dioxide is commonly known as silica. Quartz, cristobalite and tridymite are different crystalline forms of silica. They are inter-convertible at a suitable temperature.

Silicon dioxide (silica) is a covalent three dimensional network solid, in which each silicon atom is covalently bound in tetrahedral manner to four oxygen atoms. The crystal contains eight membered rings having alternate silicon and oxygen atoms.

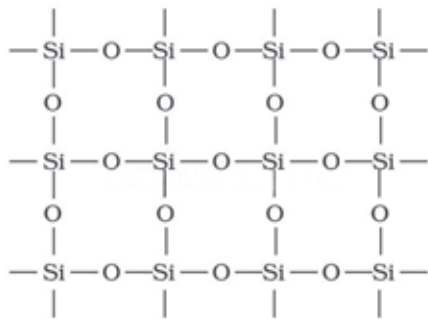

Structure of SiO_2

9.7.6 Nitric acid (HNO_3) : Nitric acid is a strong, oxidising mineral acid. The central nitrogen atom is sp^2 hybridised. HNO_3 exhibits resonance phenomenon.

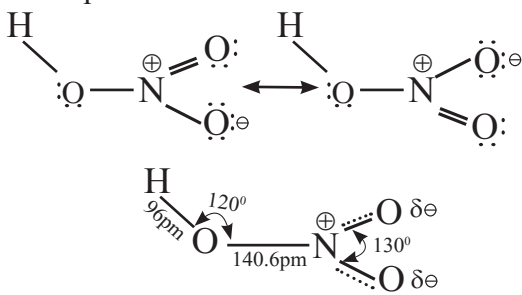

Resonance Hybrid of HNO_3

9.6.7 Orthophosphoric acid/phosphoric acid (H_3PO_4) : Phosphorus forms number of oxyacids. Orthophosphoric acid is a strong non toxic mineral acid. It contains three ionizable acidic hydrogens. The central phosphorous atom is tetrahedral.

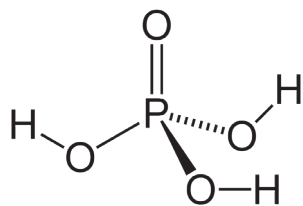

Try this

Find out the structural formulae of various oxyacids of phosphorus.

9.8 Chemistry of notable compounds of elements of groups 13, 14 and 15

9.8.1 Borax ($\text{Na}_2\text{B}_4\text{O}_7$) : It is one of the most important boron compound. The crystalline borax has formula $\text{Na}_2\text{B}_4\text{O}_7 \cdot 10\text{H}_2\text{O}$ or $\text{Na}_2[\text{B}_4\text{O}_5(\text{OH})_4] \cdot 8\text{H}_2\text{O}$.

Borax naturally occurs as tincal (which contains about 90% borax) in certain inland lakes in India, Tibet and California (U.S.A)

It is prepared from the mineral colemanite by boiling it with a solution of sodium carbonate.

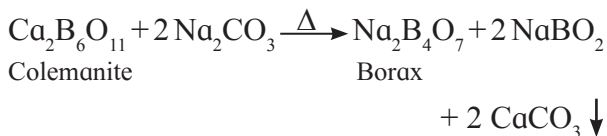

Properties

- Borax is white crystalline solid.
- Borax dissolves in water and gives alkaline solution due to its hydrolysis.

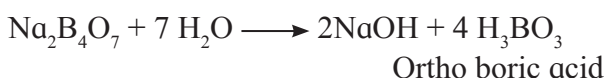

- On heating borax first loses water molecules and swells. On further heating it turns into a transparent liquid, which solidifies into glass like material known as borax bead.

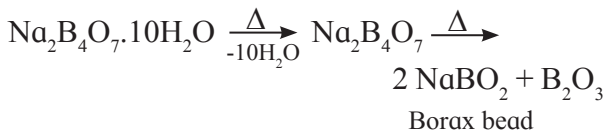

The borax bead consisting sodium metaborate and Boric anhydride is used to detect coloured transition metal ions, under the name borax bead test. For example, when borax is heated in a Bunsen burner flame with CoO on a loop of platinum wire, a blue coloured $\text{Co}(\text{BO}_2)_2$ bead is formed.

- Borax when heated with ethyl alcohol and concentrated H_2SO_4 acid, give volatile vapours of triethyl borate which burn with green edged flame.

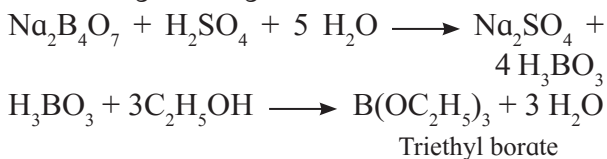

Remember

The above reaction is used as a test for detection and removal of borate in qualitative analysis.

Uses : Borax is used

- In the manufacture of optical and hard borosilicate glass.
- As a flux for soldering and welding.
- As a mild antiseptic in the preparation of medical soaps
- In quantitative analysis for borax bead test.
- As a brightener in washing powder.

9.8.2 Silicones : Silicones represent organo-silicon polymers where in $\{R_2SiO\}$ as a repeating units are held together by $\begin{array}{c} | \\ -Si-O-Si- \\ | \end{array}$ linkage

They have empirical formula R_2SiO ($R = CH_3$ or C_6H_5 group), is similar to that of ketone (R_2CO) and hence the name silicones.

Preparation : The starting material for manufacture of silicones are alkyl or aryl substituted silicon chlorides, $R_nSiCl_{(4-n)}$ where R is alkyl or aryl group.

When methyl chloride reacts with silicon in the presence of copper catalyst at a temperature 573 K, various types of methyl substituted chlorosilane of formula $MeSiCl_3$, Me_2SiCl_2 , Me_3SiCl with small amounts of Me_4Si are formed.

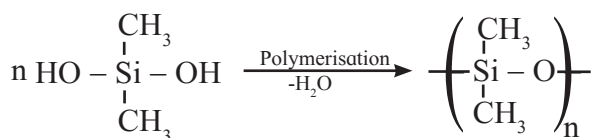
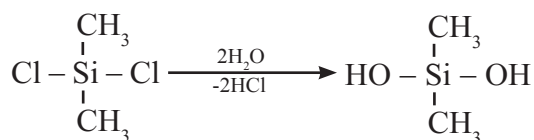
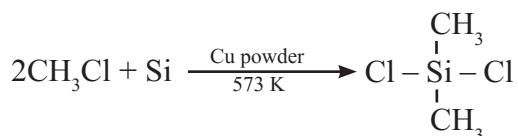

Hydrolysis of dimethyl dichlorosilane, $(CH_3)_2SiCl_2$ followed by condensation polymerisation yields straight chain silicone polymers.

The chain length of polymer can be controlled by adding $(CH_3)_3SiCl$ at the end as shown :

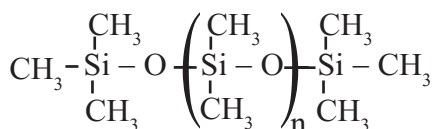

Properties of silicones

- They are water repellent.
- They have high thermal stability.
- They are good electrical insulators.
- They are resistant to oxidation and chemicals.

Uses of silicones

They are used as

- insulating material for electrical appliances
- water proofing of fabrics
- sealant
- high temperature lubricants
- For mixing in paints and enamels to make them resistant to high temperature, sunlight and chemicals.

9.8.3 Ammonia (NH₃)

Preparation

- Ammonia is present in small quantities in air and soil where it is formed by the decomposition of nitrogenous organic matter e. g. urea.

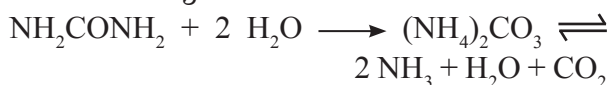

- Ammonia is prepared on laboratory scale, by decomposition of the ammonium salts with calcium hydroxide or caustic soda.

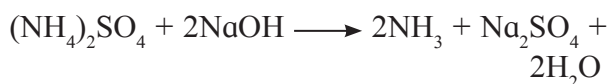
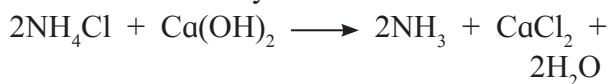

- On the large scale ammonia is prepared by direct combination of dinitrogen and dihydrogen. (Haber's process)

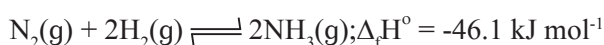

High pressure favours the formation of ammonia. The optimum conditions for the production of ammonia are high pressure of 200×10^5 Pa (200 atm), temperature of ~ 700 K and use of a catalyst such as iron oxide with trace amounts of K_2O and Al_2O_3 . Under these conditions equilibrium attains rapidly.

Properties

a. Physical properties

- Ammonia is colourless gas with pungent odour.
- It has freezing point of 198.4 K and boiling point of 239.7 K.
- It is highly soluble in water. The concentrated aqueous solution of NH_3 is called liquor ammonia.



Remember

Ammonia has higher melting point and boiling point, because in the solid and liquid state NH_3 molecules get associated together through hydrogen bonding. Thus some more energy is required to break such intermolecular hydrogen bonds.

b. Chemical properties

i. Basic nature : The aqueous solution of ammonia is basic in nature due to the formation of OH^- ions.

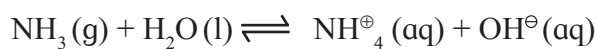

ii. Ammonia reacts with acids to form ammonium salts.

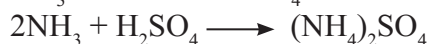
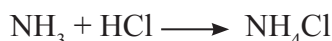

iii. Aqueous solution of ammonia precipitates out as hydroxides (or hydrated oxides) of metals from their salt solutions.

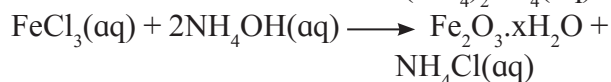
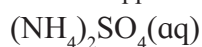
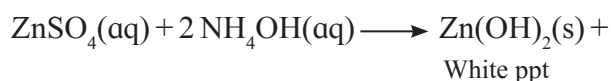

iv. Complex formation :

The lone pair of electrons on nitrogen the atom facilitates complexation of ammonia with transition metal ions.

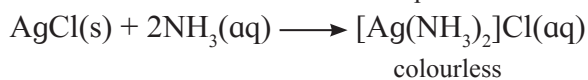
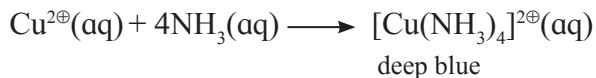

Remember

This reaction is used for the detection of metal ions such as Cu^{2+} , Ag^+ .

Uses

Ammonia is used in

- manufacture of fertilizers such as urea, diammonium phosphate, ammonium nitrate, ammonium sulphate etc.
- manufacture of some inorganic compounds like nitric acid.
- refrigerant (liq. ammonia).
- laboratory reagent in qualitative and quantitative analysis (aq. solution of ammonia)



Remember

Ammonia gives brown ppt with Nessler's reagent (alkaline solution of K_2HgI_4).

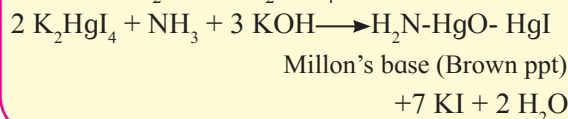
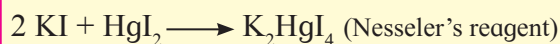
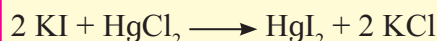



Exercises

1. Choose correct option.

- A. Which of the following is not an allotrope of carbon ?
 a. bucky ball b. diamond
 c. graphite d. emerald
- B. is inorganic graphite
 a. borax b. diborane
 c. boron nitride d. colemanite
- C. Haber's process is used for preparation of
 a. HNO_3 b. NH_3
 c. NH_2CONH_2 d. NH_4OH
- D. Thallium shows different oxidation state because
 a. of inert pair effect
 b. it is inner transition element
 c. it is metal
 d. of its high electronegativity
- E. Which of the following shows most prominent inert pair effect ?
 a. C b. Si
 c. Ge d. Pb

2. Identify the group 14 element that best fits each of the following description.

- A. Non metallic element
 B. Form the most acidic oxide
 C. They prefer +2 oxidation state.
 D. Forms strong π bonds.

3. Give reasons.

- A. Ga^{3+} salts are better reducing agent while Tl^{3+} salts are better oxidising agent.
 B. PbCl_4 is less stable than PbCl_2

4. Give the formula of a compound in which carbon exhibit an oxidation state of

- A. +4 B. +2 C. -4

5. Explain the trend of the following in group 13 elements :

- A. atomic radii B. ionization enthalpy
 C. electron affinity

6. Answer the following

- A. What is hybridization of Al in AlCl_3 ?
 B. Name a molecule having banana bond.

7. Draw the structure of the following

- A. Orthophosphoric acid
 B. Resonance structure of nitric acid

8. Find out the difference between

- A. Diamond and Graphite
 B. White phosphorus and Red phosphorus

9. What are silicones? Where are they used?

10. Explain the trend in oxidation state of elements from nitrogen to bismuth.

11. Give the test that is used to detect borate radical is qualitative analysis.

12. Explain structure and bonding of diborane.

13. A compound is prepared from the mineral colemanite by boiling it with a solution of sodium carbonate. It is white crystalline solid and used for inorganic qualitative analysis.

- a. Name the compound produced.
 b. Write the reaction that explains its formation.

14. Ammonia is a good complexing agent. Explain.

15. State true or false. Correct the false statement.

- A. The acidic nature of oxides of group 13 increases down the graph.
 B. The tendency for cantenation is much higher for C than for Si.

16. Match the pairs from column A and B.

A	B
BCl_3	Angular molecule
SiO_2	linear covalent molecule
CO_2	Tetrahedral molecule
	Planar trigonal molecule

17. Give the reactions supporting basic nature of ammonia.

18. Shravani was performing inorganic qualitative analysis of a salt. To an aqueous solution of that salt, she added silver nitrate. When a white precipitate was formed. On adding ammonium hydroxide to this, she obtained a clear solution. Comment on her observations and write the chemical reactions involved.



Activity :

Prepare models of allotropes of carbon and phosphorous.

10. States of Matter : Gaseous and liquid states

10.1 Introduction:

We have learnt that substances exist in one of the three main states of matter. The three distinct physical forms of a substance are Solid, Liquid, and Gas.

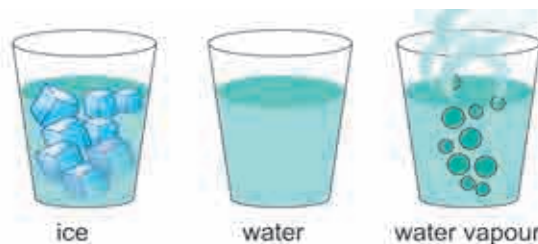

Fig. 10.1 : Different States of Water



Can you recall?

Water exists in the three different forms solid ice, liquid water and gaseous vapours.

Key points of differentiation between the three states can be understood as given in Table 10.1.

Three states of matter are interconvertible by exchange of Heat as given below:

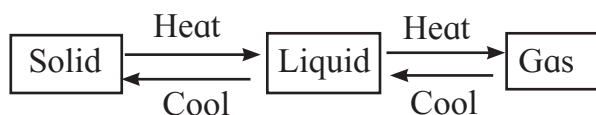

Table 10.1: Distinguishing points between Solid, Liquid and Gas

Sr. No.	Points	Solid	Liquid	Gas
1	Microscopic view Mean atomic/ molecular separation	 Mean separation $\approx 3-5\text{\AA}$	 Mean separation $\approx 3-10\text{\AA}$	 Mean separation $> 5\text{\AA}$
2	Arrangement of particles (atoms/molecules)	Particles are tightly held, and have regular arrangement of atoms/molecules	Particles are loosely packed, irregular arrangement of particles	Particles are more loosely packed, highly irregular arrangement
3	Movement of particles	Particles cannot move freely as they occupy fixed positions.	Particles can move a small distance within the liquid	Particles are in continuous random motion.
4	Shape and volume	Has definite shape and volume	Takes the shape of the container and has definite volume.	Takes the shape and the volume of its container.
5	Intermolecular space	Very small Intermolecular space	Moderate Intermolecular space	Large Intermolecular space.
6	Effect of a small change in temperature	Volume change is small	Moderate effect on volume change	Volume change significantly high.
7	Compression or Expansion	Practically Non-compressible	Small Compressibility	Compressible

10.2 Intermolecular Forces : Intermolecular forces are the attractive forces as well as repulsive forces present between the neighbouring molecules. The attractive force decreases with the increase in distance between the molecules. The intermolecular forces are strong in solids, less strong in liquids and very weak in gases. Thus, the three physical states of matter can be determined as per the strength of intermolecular forces.

The physical properties of matter such as melting point, boiling point, vapor pressure, viscosity, evaporation, surface tension and solubility can be studied with respect to the strength of attractive forces between the molecules. During the melting process intermolecular forces are partially overcome, whereas they are overcome completely during the vapourization process.

10.2.1 Types of Intermolecular Forces:

The four types of intermolecular forces are-

- i. Dipole-dipole interactions
- ii. Ion-dipole interactions
- iii. Dipole-Induced dipole interaction
- iv. Hydrogen bonding
- v. London Dispersion Forces

i. Dipole-dipole interactions : Polar molecules experience dipole-dipole forces due to electrostatic interactions between dipoles on neighboring molecules.

What are polar molecules or Polar covalent molecules? (Refer to Chapter 5).

Polar covalent molecule is also described as “dipole” meaning that the molecule has two ‘poles’. The covalent bond becomes polar due to electronegativity difference between the bonding atoms. Hence polarity is observed in the compounds containing dissimilar atoms. For example, HCl molecule (see Fig. 10.2 (a)).

One end (pole) of the molecule has partial positive charge on hydrogen atom while at other end chlorine atom has partial negative charge (denoted by Greek letter ‘ δ ’ delta). As a result of polarisation, the molecule possesses the dipole moment.

Dipole moment (μ) is the product of the magnitude of the charge (Q) and the distance between the centres of positive and negative charge (r). It is designated by a Greek Letter (μ) (μ). Its unit is debye (D).

Dipole moment is a vector quantity and is depicted by a small arrow with tail in the positive centre and head pointing towards the negative centre.

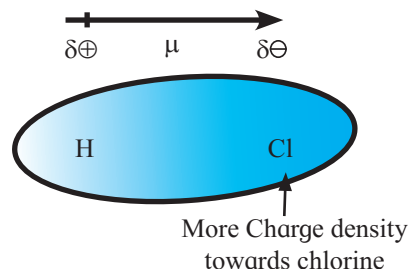

Unequal sharing of electrons between the bonding atoms.

Fig 10.2 (a) : Polar molecule

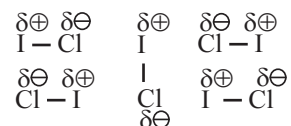

Fig 10.2 (b) : Dipole-dipole interaction

For example, the dipole moment of HF may be represented as: $\overset{+}{\text{H}}-\overset{-}{\text{F}}:$

The crossed arrow ($\overset{+}{\text{H}}-\overset{-}{\text{F}}:$) above the Lewis structure represents an electron density shift.

Thus polar molecules have permanent dipole moments. When a polar molecule encounters another polar molecule, the positive end of one molecule is attracted to the negative end of another polar molecule. Many such molecules have dipoles and their interaction is termed as dipole-dipole interaction. These forces are generally weak, with energies of the order of 3-4 kJ mol⁻¹ and are significant only when molecules are in close contact. i.e. in a solid or a liquid state.

For example C₄H₉Cl, (butyl chloride), CH₃ - O - CH₃ (dimethyl ether) ICl (iodine chloride B.P. 27 °C), are dipolar liquids. The molecular orientations due to dipole-dipole interaction in ICl liquid is shown in Fig. 10.2 (b).

In brief, more polar the substance, greater the strength of its dipole-dipole interactions. Table 10.2 enlists several substances with similar molecular masses but different dipole moments. From Table 10.2, it is clear that higher the dipole moment, stronger are the inter molecular forces, generally leading to higher boiling points.

Table 10.2 : Effect of dipole moments on boiling point (b.p.)

Substance	Molar Mass (amu)	Dipole Moment (D)	b.p. (K)
CH ₃ - CH ₂ - CH ₃	44.10	0.1	231
CH ₃ - O - CH ₃	46.07	1.3	248
CH ₃ - Cl	50.49	1.9	249
CH ₃ - CN	41.05	3.9	355

When different substances coexist in single phase, following intermolecular interactions are present.

ii. Ion-dipole interactions : An ion-dipole force is the result of electrostatic interactions between an ion (cation or anion) and the partial charges on a polar molecule.

The strength of this interaction depends on the charge and size of an ion. It also depends on the magnitude of dipole moment and size of the molecule.

(Hydrated Na⁺ ion)

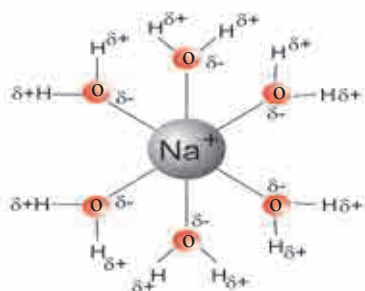

Fig. 10.2 (c) : Na⁺ ion(cation) - H₂O interaction

Ion-dipole forces are particularly important in aqueous solutions of ionic substances such as sodium chloride (NaCl). When an ionic compound, sodium chloride is dissolved in water, the ions get separated and surrounded by water molecules which is called **Hydration** of sodium ions.

Cations are smaller in size than the isoelectronic anions. The charge density on cation (Na⁺) is more concentrated than anion (Cl⁻). This makes the interaction between (Na⁺) and negative end of the polar H₂O molecule (Fig. 10.2 (c)) stronger than the corresponding interaction between (Cl⁻) and positive end of the polar H₂O molecule.

More the charge on cation, stronger is the ion-dipole interaction. For example, Mg²⁺ ion has higher charge and smaller ionic radius (78 pm) than Na⁺ ion (98 pm), hence Mg²⁺ ion is surrounded (hydrated) more strongly with water molecules and exerts strong ion-dipole interaction.

Thus the strength of interaction increases with increase in charge on cation and with decrease in ionic size or radius. Therefore, ion-dipole forces increase in the order :

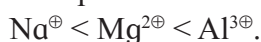

iii. Dipole-Induced dipole interaction :

When polar molecules (like H₂O, NH₃) and nonpolar molecules (like benzene) approach each other, the polar molecules induce dipole in the non-polar molecules. Hence 'Temporary dipoles' are formed by shifting of electron clouds in nonpolar molecules. For example, Ammonia (NH₃) is polar and has permanent dipole moment while Benzene (C₆H₆) is non polar and has zero dipole moment. The force of attraction developed between the polar and nonpolar molecules is of the type dipole - induced dipole interaction. It can be seen in Fig 10.2(d) in the following manner:

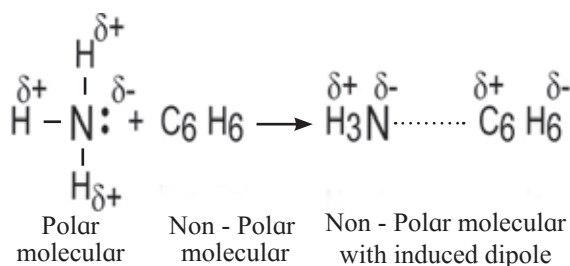

Fig. 10.2 (d) : Dipole - induced dipole interaction

iv. London Dispersion Force : The study of intermolecular forces present among nonpolar molecules or the individual atoms of a noble gas is very interesting. For example, Benzene (C_6H_6) has zero dipole moment and experiences no dipole-dipole forces, yet exists in liquid stage.

In case of nonpolar molecules and inert gases, only dispersion forces exist. Dispersion forces are also called as **London forces** due to an idea of momentary dipole which was proposed by the German Physicist, **Fritz London** in 1930. These forces are also called as **van der Waals forces**. It is the weakest intermolecular force that develops due to interaction between two nonpolar molecules. In general, all atoms and molecules experience London dispersion forces, which result from the motion of electrons. At any given instant of time, the electron distribution in an atom may be asymmetrical, giving the atom a short lived dipole moment. This momentary dipole on one atom can affect the electron distribution in the neighbouring atoms and induce momentary dipoles in them. As a result, weak attractive force develops.

For example, substances composed of molecules such as O_2 , CO_2 , N_2 , halogens, methane gas, helium and other noble gases show van der Waals force of attraction.

The strength of London forces increases with increase in molecular size, molecular mass and number of electrons present in an atom or molecule.

When two nonpolar molecules approach each other, attractive and repulsive forces between their electrons and the nuclei will lead to distortions in the size of electron cloud, a property referred to as polarizability.

Polarizability is a measure of how easily an electron cloud of an atom is distorted by an applied electric field. It is the property of atom. The ability to form momentary dipoles that means the ability of another molecule to become polar by redistributing its electrons is known as **polarizability** of the atom or molecule.

More the number of electrons in a

molecule, higher is its ability to become polar. Similarly more the spread out shapes, higher the dispersion forces present between the molecules. London dispersion forces are stronger in a long chain of atoms where molecules are not compact. This can affect physical property such as B.P. n-Pentane, for example boils at 309.4 K, whereas neo - pentane boils at 282.7 K. Here both the substances have the same molecular formula, C_5H_{12} , but n-pentane is longer and somewhat spread out, where as neo-pentane is more

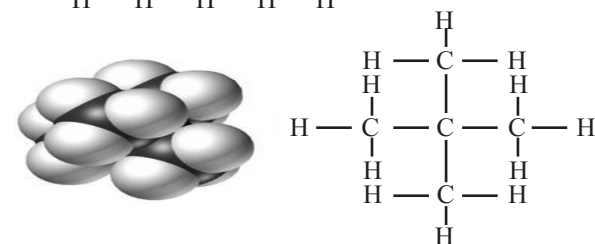
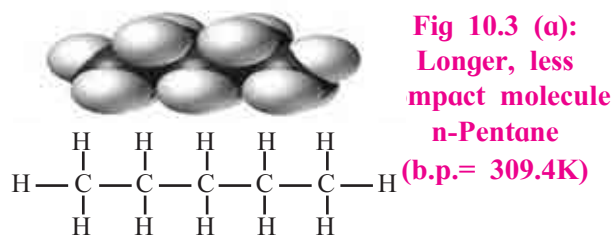

Fig 10.3 (b): More compact molecule neo - pentane (b.p.= 282.7K)

spherical and compact (see Fig. 10.3).

v. Hydrogen Bonding : A hydrogen bond is a special type of dipole-dipole attraction which occurs when a hydrogen atom is bonded to a strongly electronegative atom or an atom with a lone pair of electrons. Hydrogen bonds are generally stronger than usual dipole - dipole and dispersion forces, and weaker than true covalent or ionic bonds.

Definition : The electrostatic force of attraction between positively polarised hydrogen atom of one molecule and a highly electronegative atom (which may be negatively charged) of other molecule is called as **hydrogen bond**.

Strong electronegative atoms that form hydrogen bonds are nitrogen, oxygen, and fluorine. Hydrogen bond is denoted by (...) dotted line. Hydrogen bond which occurs within one single molecule represents **Intramolecular Hydrogen bond**.

A hydrogen bond present between two like or unlike molecules, represents **Intermolecular Hydrogen bond**.

(See Fig. 10.4 (a) and (b)).

i. Inter molecular H-bonding

H-bonding in H-F :

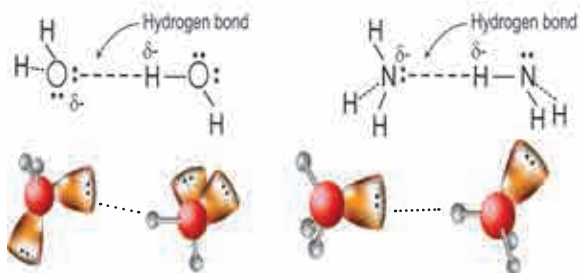
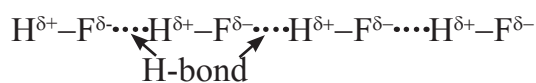
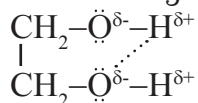

Fig. 10.4 : H-bonding in H_2O (above) and NH_3 (below) (solid line denotes covalent bond, dotted line denotes hydrogen bond)

ii. Intra molecular H-bonding :

H-bonding in ethylene glycol :



H - bonding and boiling point : Due to the presence of H-bonding in the compounds, more energy is required to break the bonds. Therefore, boiling point is more in case of liquid molecules containing H-bond. Hydrogen bonds can be quite strong with energies up to 40 kJ/mol.

Water in particular is able to form a vast three dimensional network of hydrogen bonds as shown in Fig. 10.5. It is because each H_2O molecule has two hydrogen atoms and two

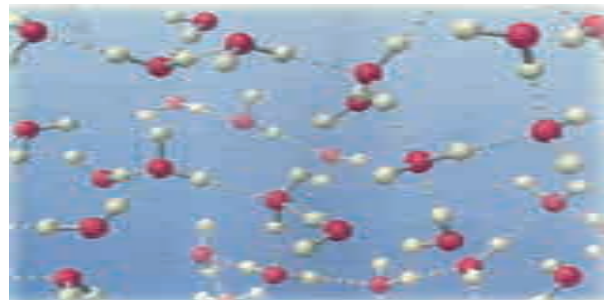

Fig. 10.5 : Liquid water contains a vast three dimensional network of hydrogen bonds

electron pairs on oxygen atom.

The boiling point generally increases with increase in molecular mass, but the hydrides of nitrogen (NH_3), oxygen (H_2O) and fluorine (HF) have abnormally high boiling points due to the presence of hydrogen bonding between the molecules.

Similarly due to presence of H- bond, viscosity of liquid increases. Hydrogen bonds play vital role in determining structure and properties of proteins and nucleic acid present in all living organisms. In case of gases intermolecular forces of attraction are very weak.

10.2.2 Intermolecular Forces and Thermal energy :

Thermal energy is the measure of kinetic energy of the particles of matter that arises due to movement of particles (about which you must have learnt in Physics). It is directly proportional to the temperature; that means thermal energy increases with increase in temperature and vice versa.

Three states of matter are the consequence of a balance between the intermolecular forces of attraction and the thermal energy of the molecules.

If the intermolecular forces are very weak, molecules do not come together to make liquid or solid unless thermal energy is decreased by lowering the temperature.

When a substance is to be converted from its gaseous state to solid state, its thermal energy (or temperature) has to be reduced. At this stage, the intermolecular forces become more important than thermal energy of the particles.

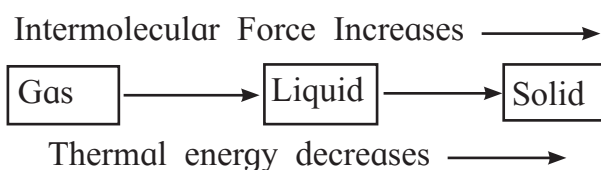

A comparison of various kinds of intermolecular forces discussed in this section is made in Table 10.3.

Table 10.3 : Comparison of Intermolecular Forces

Force	Strength	Characteristics
Ion-dipole	Moderate (10 - 50 kJ/mol)	Occurs between ions and polar solvents
Dipole-dipole	Weak (3 - 4 kJ/mol)	Occurs between polar molecules
London dispersion	Weak (1 - 10 kJ/mol)	Occurs between all molecules; strength depends on size, polarizability
Hydrogen bond	Moderate (10 - 40 kJ/mol)	Occurs between molecules with O-H, N-H, and H-F bonds



Can you tell?

What are the various components present in the atmosphere?

Name five elements and five compounds those exist as gases at room temperature.



Do you know ?

Among the three compounds H_2 , H_2S and H_2Se , the first one, H_2O has the smallest molecular mass. But it has the highest B.P. of $100^\circ C$. B.P. of H_2S is $-60^\circ C$ and of H_2Se is $-41.25^\circ C$. The extraordinary high B.P. of H_2O is due to very strong hydrogen bonding even though it has the lowest molecular mass.



Just think

What is air?

It is a mixture of various gases. Air, we can not see but feel the cool breeze. The composition of air by volume is around 78 percent N_2 , 21 percent O_2 and 1 percent other gases including CO_2 . The chemistry of atmospheric gases is an important subject of study as it involves air pollution. O_2 in air is essential for survival of aerobic life.

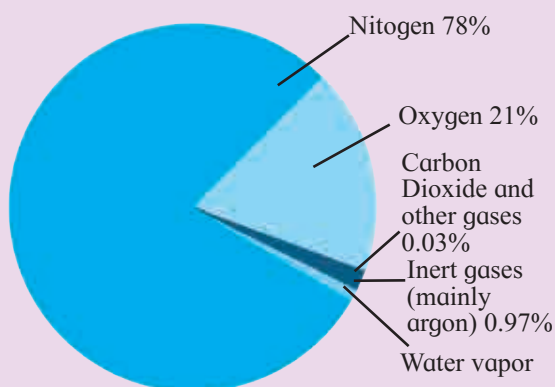

Composition of air with respect to proportion of various gases

10.3 Characteristic properties of Gases :

Under normal conditions, out of 118 elements from the periodic table, only a few (eleven) elements exist as gases. The gaseous state is characterized by the following physical properties :

1. Gases are lighter than solids and liquids i.e. possess lower density.
2. Gases do not possess a fixed volume and shape. They occupy entire space available and take the shape of the container.
3. Gas molecules are widely separated and are in continuous, random motion. Therefore, gases exert pressure equally in all directions due to collision of gas molecules, on the walls of the container.
4. In case of gases, intermolecular forces are weakest.
5. Gases possess the property of diffusion which is a spontaneous homogenous inter mixing of two or more gases.
6. Gases are highly compressible.

Measurable properties of Gases : (Refer to Chapter 1) : Some Important measurable properties of the gases are given below :

1. Mass: The mass, m , of a gas sample is measure of the quantity of matter it contains. It can be measured experimentally. SI unit of mass of gas is kilogram (kg). $1kg = 10^3g$.

The mass of a gas is related to the number of moles (n) by the expression i.

$$i. \quad n = \frac{\text{mass in grams}}{\text{molar mass in grams}} = \frac{m}{M}$$

The following expressions are also useful in calculations.

$$ii. \quad n = \frac{\text{Number of molecules}}{\text{Avogadro Number}} = \frac{N}{N_A} = \frac{N}{6.022 \times 10^{23}}$$

$$iii. \quad n = \frac{\text{Volume of a given gas in litres at STP}}{22.414 \text{ litres at STP}}$$

2. Volume: Volume (V) of a sample of gas is the amount of space it occupies. It is expressed in terms of different units like Litres (L), millilitres (mL), cubic centimeter (cm^3), cubic meter (m^3) or decimeter cube (dm^3). SI Unit of the volume is cubic meter (m^3).

Most commonly used unit to measure the volume of the a gas is decimeter cube or litre.

$$1 \text{ L} = 1000 \text{ mL} = 1000 \text{ cm}^3 = 1 \text{ dm}^3$$

$$1 \text{ m}^3 = 10^3 \text{ dm}^3 = 10^3 \text{ L} = 10^6 \text{ cm}^3 = 10^6 \text{ mL}$$

3. Pressure: Pressure (P) is defined as force per unit area.

$$\text{Pressure} = \frac{\text{Force}}{\text{Area}} = \frac{f}{a}$$

Pressure of gas is measured with 'manometer' and atmospheric pressure is measured by 'barometer'.

SI Unit of pressure is pascal (Pa) or Newton per meter square (N m^{-2}).

$$1 \text{ Pa} = 1 \text{ Nm}^{-2} = 1 \text{ kg m}^{-1} \text{ s}^{-2}$$

$$1 \text{ bar} = 1.00 \times 10^5 \text{ Pa}$$

The bar is now replacing the standard atmosphere (atm) as the most convenient unit of pressure.

$$1 \text{ atm} = 76 \text{ cm of Hg} = 760 \text{ mm of Hg} = 760 \text{ torr as } 1 \text{ torr} = 1 \text{ mm Hg}$$

$$1 \text{ atm} = 101.325 \text{ kPa} = 101325 \text{ Pa} = 1.01325 \times 10^5 \text{ N m}^{-2} = 1.01325 \text{ bar.}$$



Use your brain power

Find the unit in which car-tyre pressure is measured.

4. Temperature : It is the property of an object that determines direction in which energy will flow when that object is in contact with other object.

In scientific measurements temperature (T) is measured either on the celsius scale ($^{\circ}\text{C}$) or the Kelvin scale (K). (Note that degree sign is not used in Kelvin unit).

SI Unit of Temperature of a gas is kelvin (K). The celsius and kelvin scales are related by the expression

$$T \text{ (K)} = t^{\circ}\text{C} + 273.15$$

5. Density : It is the mass per unit volume.

$$d = \frac{m}{V}$$

\therefore SI Unit of density is kg m^{-3} .

In the case of gases, relative density is measured with respect to hydrogen gas and is called vapour density.

$$\therefore \text{ Vapour density} = \frac{\text{molar mass}}{2}$$

6. Diffusion: In case of gases, Rate of diffusion of two or more gases is measured.

$$\text{Rate of diffusion} = \frac{\text{Volume of a gas diffused}}{\text{time required for diffusion}}$$

\therefore SI Unit for Rate of diffusion is $\text{dm}^3 \text{ s}^{-1}$ or $\text{cm}^3 \text{ s}^{-1}$

10.4 Gas Laws : The behavior of gases can be studied by four variables namely pressure, volume, temperature and the number of moles. These variables and measurable properties of the gases are related with one another through different gas laws.

Think of a gas in a cylinder or a sealed container. We can measure number of moles (n) of gas inside, the pressure (P) of a gas, the volume (V) of a gas (which is equal to the volume of the container) and the temperature (T) of the gas. The observed relationships between P , V , n and T are summarized by five gas laws: Boyle's law, Charles' law, Gay Lussac law, Avogadro law and Dalton's law.

The gas laws are based on the experimental observations made by the scientists. Further, these gas laws have played significant role in the development of chemistry.

10.4.1 Boyle's Law: (Pressure-Volume Relationship)



Do you know ?

How does the bicycle pump work ? You can feel the increased pressure of a gas on your palm by pushing in the piston of a bicycle pump. As you push, you squash the same number of particles into a smaller volume. This squashing means particles hit the walls of the pump more often, increasing the pressure.



In 1662, Robert Boyle carried out large number of experiments on various gases. He observed that at constant temperature when the pressure was increased, the volume of the gas was reduced and vice versa.

Statement of Boyle's law: For a fixed mass (number of moles 'n') of a gas at constant temperature, the pressure (P) of a gas is inversely proportional to the volume (V) of gas.

OR

At constant temperature, the pressure of fixed amount (number of moles) of a gas varies inversely with its volume.

The law can be illustrated diagrammatically as shown in Fig. 10.6

Increasing or decreasing the volume of a gas at a constant temperature

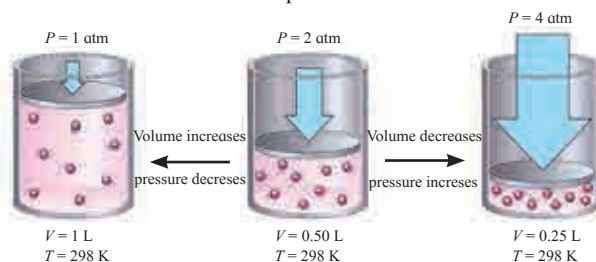

Fig. 10.6 : Schematic illustration of Boyle's Law

Mathematical Expression :

Mathematically, Boyle's law is expressed as

$$P \propto \frac{1}{V} \quad (\text{at constant } T \text{ and } n)$$

$$\therefore P = k_1 \frac{1}{V} \dots\dots\dots (10.1)$$

(where k_1 is proportionality constant)

on rearranging, Eq. (10.1) becomes :

$$\therefore P V = k_1 \dots\dots\dots (10.2)$$

It means that at constant temperature, product of pressure and volume of the fixed amount of a gas is constant.

Thus, when a fixed amount of a gas at constant temperature (T) occupying volume V_1 initially at pressure (P_1) undergoes expansion or compression, volume of the gas changes to V_2 and pressure to P_2 .

According to Boyle's law,

$$P_1 V_1 = P_2 V_2 = \text{constant} \dots\dots(10.3)$$

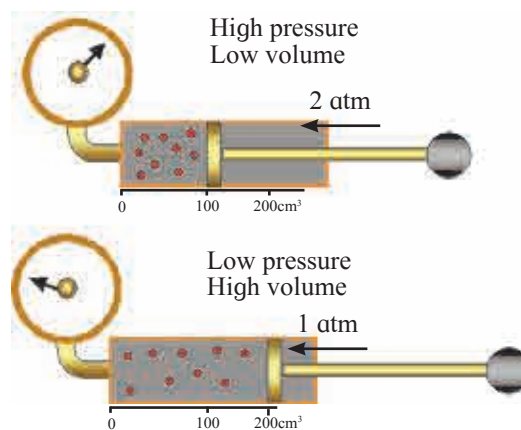
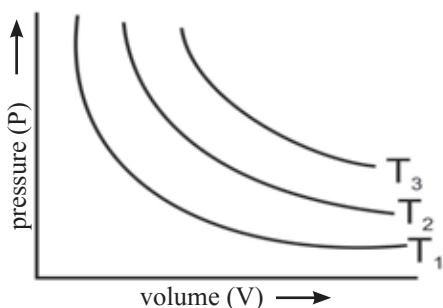

Fig. 10.7 : Schematic of the experiment Boyle's law

Figure 10.7 illustrates the Boyle's law experiment when the applied pressure increases from 1 atm to 2 atm and volume of the gas decreases from 200 cm³ to 100 cm³.

Graphical Representation : Figure 10.8 shows how the pressure-volume relationship can be expressed graphically. Figure 10.8 (a) shows a graph of the equation $PV = k$ at a given constant temperature, known as Isotherm (constant temperature plot). For a given mass of a gas, the value of k varies only with temperature.



a. Graph of pressure, P , vs volume, V , of a gas at different temperatures T_1, T_2, T_3 .

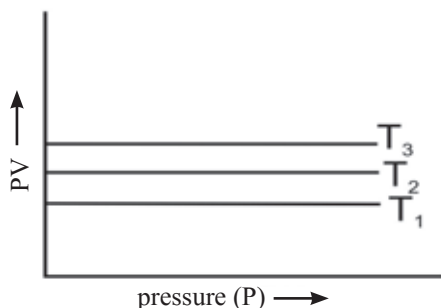

b. Graph of PV vs pressure, P , of a gas at different temperatures T_1, T_2, T_3 .

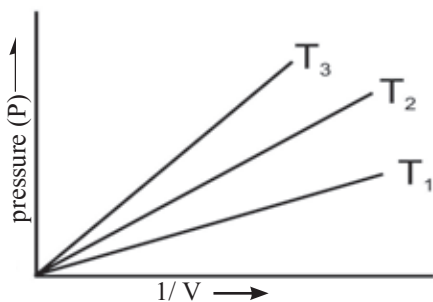

c. Graph of pressure, P , of a gas vs $1/V$ at different temperatures T_1, T_2, T_3 .

Fig. 10.8 : Boyle's law : Graphical representation

If the product of pressure and volume (PV) is plotted against pressure (P), a straight line is obtained parallel to x -axis (pressure axis) as in Fig 10.8 (b).

When the pressure (P) of the gas is plotted against ($1/V$), a straight line is obtained passing through the origin as shown in Fig. 10.8 (c), provided T and n are constant.

However, at high pressure, deviation from Boyle's law is observed in the behavior of gases.

Boyle's law in terms of density of gas : With increase in pressure, gas molecules get closer and the density (d) of the gas increases. Hence, at constant temperature, pressure is directly proportional to the density of a fixed mass of gas. Therefore, from Eq. (10.2).

$$PV = k_1 \quad \dots\dots\dots(10.2)$$

$$\therefore V = \frac{k_1}{P} \quad \dots\dots\dots(10.4)$$

$$\text{But } d = \frac{m}{V}$$

On Substituting V from Eq. (10.4),

$$d = \left(\frac{m}{k_1} \right) \times P$$

$$\therefore d = k'P, \quad \dots\dots\dots (10.5)$$

where k' = New Constant.

$$\therefore d \propto P$$

Above equation shows that at constant temperature, the pressure is directly proportional to the density of a fixed mass of the gas.



Internet my friend

- Watch Boyle's law experiment. www.socratica.youtube
- Find applications of Boyle's law.
- Try to study how Boyle's law helps in 'scuba-diving' i.e. Importance of Boyle's law in scuba-diving an exhilarating sport.

Problem: 10.1 : The volume occupied by a given mass of a gas at 298 K is 25 mL at 1 atmosphere pressure. Calculate the volume of the gas if pressure is increased to 1.25 atmosphere at constant temperature.

Given : $P_1 = 1 \text{ atm}$, $V_1 = 25 \text{ mL}$
 $P_2 = 1.25 \text{ atm}$, $V_2 = ?$

Solution :

According to Boyle's law,

$$P_1 V_1 = P_2 V_2$$

Substituting the values of $P_1 V_1$ and P_2 in the above expression we get

$$V_2 = \frac{P_1 V_1}{P_2} = \frac{1 \times 25}{1.25} = 20 \text{ ml}$$

Volume occupied by the gas is 20 mL

10.4.2 Charles' law : (Temperature -Volume Relationship)



Just think

1. Why does bicycle tyre burst during summer?
2. Why do the hot air balloons fly high?

J. Charles (1746-1823) and Gay Lussac (1778-1850) worked independently on influence of temperature on volume of a gas. Their experiments showed that for a given mass of a gas at constant pressure its volume increases with an increase in temperature. It was found that for an increase of every degree of temperature, volume of the gas increases by $\frac{1}{273.15}$ of its original volume at 0 °C. This observation is expressed mathematically as follows :

$$V_t = V_0 + \frac{t}{273.15} V_0 \quad \dots\dots (10.6)$$

Where V_t and V_0 are the volumes of the given mass of gas at the temperatures t °C and 0 °C.

Rearranging the Eq. (10.6) gives

$$V_t = V_0 \left(1 + \frac{t}{273.15} \right)$$

$$\therefore V_t = V_0 \left(\frac{t + 273.15}{273.15} \right) \dots\dots (10.7)$$

At this stage, a new scale of temperature was introduced, namely, the **absolute temperature scale**. This absolute temperature (TK) was defined as

$$TK = t \text{ } ^\circ\text{C} + 273.15$$

This also called **thermodynamic scale of temperature**. The units of this absolute temperature scale is called (K) in the honour of **Lord Kelvin** who determined the accurate value of absolute zero as -273.15 °C in 1854. The Eq. (10.7) is now rewritten by replacing the celcius temperatures by absolute temperatures as follows :

$$V_t = V_0 \left(\frac{T_t}{T_0} \right) \quad \dots\dots (10.8)$$

where $T_t = t + 273.15$ and $T_0 = 273.15$

The Eq. (10.8) on rearrangement takes the following form :

$$\frac{V_t}{T_t} = \frac{V_0}{T_0}$$

From this, a general equation can be written as follows :

$$\frac{V_1}{T_1} = \frac{V_2}{T_2} \quad \dots\dots (10.9)$$

$$\therefore \frac{V}{T} = \text{constant} = k_2$$

$$\therefore V = k_2 T \quad \dots\dots (10.10)$$

The Eq. (10.10) is the mathematical expression of Charles law, which is stated as follows :

'At constant pressure, the volume of a fixed mass of a gas is directly proportional to its temperature in kelvin.'

The law can be illustrated diagrammatically as shown in Fig. 10.9.

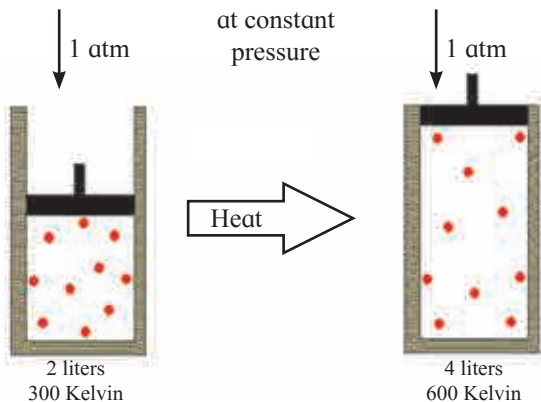

Fig. 10.9 : At constant pressure, volume changes with temperature

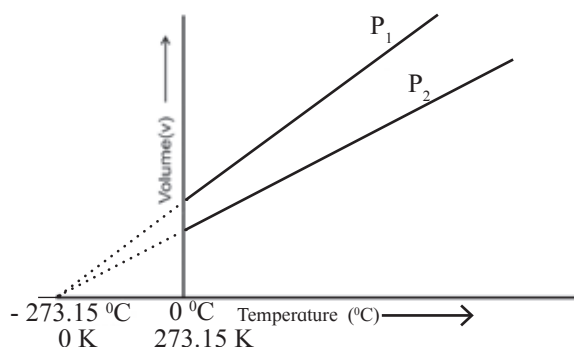

Fig. 10.10 : Graph of volume against temperature

Absolute zero temperature and Charles law

According to Charles law, Eq. (10.10), the graph of volume of a gas (at given constant pressure, say P_1) plotted versus its temperature in celsius, is a straight line with a positive slope. (See Fig. 10.10). On extending the line to zero volume, the line intercepts the temperature axis at $-273.15\text{ }^\circ\text{C}$. At any other value of pressure, say P_2 , a different straight line for the volume temperature plot is obtained, but we get the same zero - volume temperature intercept at $-273.15\text{ }^\circ\text{C}$. The straight line of the volume versus temperature graph at constant pressure is called **isobar**. Zero volume for a gas sample is a hypothetical state. In practice all the gases get liquified at a temperature higher than $-273.15\text{ }^\circ\text{C}$. This temperature is the lowest temperature that can be imagined but practically cannot be attained. It is the **absolute zero** temperature on the kelvin scale (0 K).

Isobars: A graph of volume (V) vs absolute temperature (T) at a constant pressure is known as Isobar.



Remember

On the kelvin scale, water freezes at at nearly 273 K and boils at about 373 K. (Note that we write kelvin temperatures in K without a $^\circ$ (degree) sign)

In short, Charles' law explains that at constant pressure, gases expand on heating and contract on cooling. Thus hot air is less dense than cold air.

10.4.3 Gay-Lussac's Law: (Pressure-Temperature Relationship) :



Just think

1. List out various real life examples of Charles law.
2. Refer and watch Charles law experiments.

Problem 10.2 : At 300 K a certain mass of a gas occupies $1 \times 10^{-4}\text{ dm}^3$ volume. Calculate its volume at 450 K and at the same pressure.

Given : $T_1 = 300\text{ K}$,
 $V_1 = 1 \times 10^{-4}\text{ dm}^3$, $T_2 = 450\text{ K}$,
 $V_2 = ?$

Solution : According to Charles' law, at constant pressure.

$$\frac{V_1}{T_1} = \frac{V_2}{T_2} \quad \therefore V_2 = \frac{V_1 \times T_2}{T_1}$$

$$= \frac{450 \times 1 \times 10^{-4}}{300}$$

$$\therefore V_2 = 1.5 \times 10^{-4}\text{ dm}^3$$

It relates the pressure and absolute temperature of a fixed mass of a gas at constant volume.

Statement: At constant volume, pressure (P) of a fixed amount of a gas is directly proportional to its absolute temperature (T).

Mathematical Expression:

Mathematically, the law can be expressed as :

$$P \propto T$$

$$\therefore P = k_3 T \quad \dots\dots\dots(10.11)$$

$$\therefore \frac{P}{T} = \text{constant} \quad (\text{at constant } V \text{ and } m)$$

Graphical Representation : When a graph is plotted between pressure (P) in atm and Temperature (T) in kelvin, a straight line is obtained as shown in Fig. 10.11. It is known as **isochore**. With the help of this law, one can understand relation between pressure and temperature in day to day life.

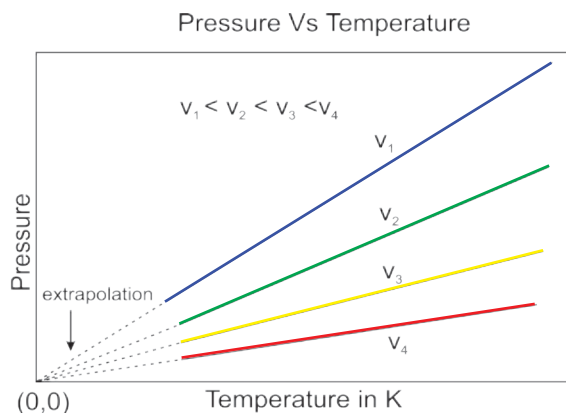

Fig. 10.11 : Pressure Vs Temperature graph of a gas

10.4.4 Avogadro Law: (Volume-Amount Relationship) :



Use your brain power

Why the pressure in the automobile tyres changes during hot summer or winter season?

In 1811 Italian scientist Amedeo Avogadro combined Dalton's atomic theory with Gay Lussac's Law of combining volumes (Chapter 1) to put forth what is known as **Avogadro law**. It states that **equal volumes of all gases at the same temperature and pressure contain equal number of molecules**. This means that at a fixed temperature and pressure, the volume of a gas depends upon the number of molecules of the gas, that is, the amount of the gas.

Avogadro law can be expressed mathematically as : $V \propto n$ (where ' n ' is the number of moles of the gas in volume ' V ')

On converting the proportionality into equation we get

$$V = k_4 n \quad \dots\dots (10.12)$$

$$\text{or } \frac{V}{n} = \text{constant} \quad (\text{at constant temperature and pressure})$$

Avogadro Law can be well represented from Fig. 10.12 as follows :

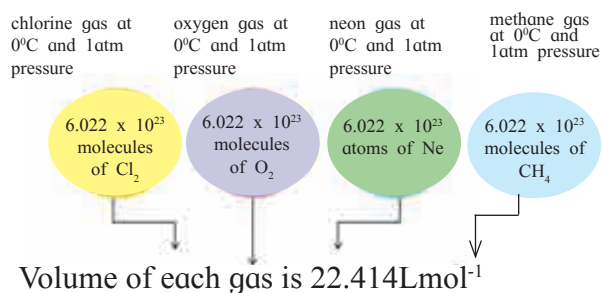

Fig. 10.12 : Avogadro Law



Can you recall?

1 mole of a gas contains Avogadro number of molecules = 6.022×10^{23} .

As the volume of a gas is directly proportional to number of moles, one mole of any gas at STP occupies $22.414 \text{ L mol}^{-1}$ volume. This volume is known as **molar volume**.



Remember

What are STP conditions?
STP means Standard Temperature and Pressure.

IUPAC has set STP as

standard Pressure = **1 bar = 10^5 Pa**
standard temperature = **273.15 K = 0°C**
Under these STP conditions molar volume of an ideal gas or mixture of two or more gases = **22.71 L mol^{-1}**

The old STP conditions are also in use, where

standard pressure = **1 atm = 1.013 bar**
standard temperature = **273.15 K = 0°C**
Under the old STP conditions molar volume of an ideal gas or mixture of two or more gases = **$22.414 \text{ L mol}^{-1}$**

Relation between molar mass and density (d) of a gas : We have learnt how to find number of moles of a gas. (Refer to Chapter 1.)

We know,

$$n = \frac{m}{M},$$

where m = mass of a gas,

M = molar mass of a gas.

Substituting in equation (10.12) we get,

$$V = k_4 \times \frac{m}{M}$$

$$\therefore M = k_4 \frac{m}{V} \quad \dots (10.13)$$

$$\text{But } \frac{m}{V} = d$$

substituting this in Eq. (10.13) we get

$$M = k_4 d \quad \dots (10.14)$$

Where d = density of a gas.

M = Molar mass

m = mass of gas

$$\therefore d \propto M$$

From Eq. (10.14), we can conclude that the density of a gas is directly proportional to its molar volume.

10.5 Ideal Gas Equation : A gas that follows strictly all the three laws; Boyle's law, Charles' law and Avogadro law is an **ideal gas**. Practically an ideal gas does not exist. Real gases show ideal behaviour under certain specific condition, when intermolecular interactions are practically absent. Yet these three gas laws and the ideal gas equation obtained by treating them mathematically are found to be very valuable in Chemistry.

10.5.1 Derivation of Ideal Gas Equation :

The three gas laws, namely, Boyle's law, Charles law and Avogadro law, are combined mathematically to obtain what is called ideal gas equation.

Let us write the proportionalities of the three gas laws :

1. At constant T and n , $V \propto \frac{1}{P}$

(Boyle's law)

2. At constant P and n , $V \propto T$

(Charles' law)

3. At constant P and T , $V \propto n$

(Avogadro law)

Combining all the above three mathematical proportionalities we get,

$$V \propto \frac{nT}{P}$$

Converting this proportionality into an equation by introducing a constant of proportionality we get,

$$\therefore V = R \left(\frac{nT}{P} \right)$$

On rearranging above equation, we obtain,

$$\therefore PV = nRT \quad \dots (10.15)$$

This equation is known as the **Ideal Gas Equation**. In the ideal gas equation, if three variables are known, fourth can be calculated. It describes the state of an ideal gas, therefore, it is also called as equation of state. Here **R** is called **Gas constant**, The value of **R** is the same for all the gases. Therefore it is called Universal gas constant.

10.5.2 Values of 'R' in different Units :

The value of **R** depends upon the units used to express P , V and T . Hence we recall STP conditions for determining values of 'R'.

i. R in SI Unit (in Joules) : Value of **R** can be calculated by using the SI units of P , V and T . Pressure P is measured in N m^{-2} or Pa, volume V in meter cube (m^3) and Temperature T in kelvin (K),

$$R = \frac{PV}{nT}$$

$$\therefore R = \frac{10^5 \text{Pa} \times 22.71 \times 10^{-3} \text{m}^3}{1 \text{ mol} \times 273.15 \text{ K}}$$

$$\therefore R = 8.314 \text{ J K}^{-1} \text{ mol}^{-1}$$

$$\text{then } R = 8.314 \text{ JK}^{-1} \text{ mol}^{-1}$$

ii. R in litre atmosphere : If pressure (P) is expressed in atmosphere (atm) and volume in litre (L) or decimeter cube (dm^3) and Temperature in kelvin (K), (that is, **old STP conditions**), then value of **R** is :

$$R = \frac{1 \text{ atm} \times 22.414 \text{ L}}{1 \text{ mol} \times 273.15 \text{ K}}$$

$$\therefore R = 0.0821 \text{ L atm K}^{-1} \text{ mol}^{-1}$$

OR

$$R = 0.0821 \text{ dm}^3 \text{ atm K}^{-1} \text{ mol}^{-1}$$

Note : Often Pressure (P) is measured in atmosphere (atm). The conversion between the units is done by noting that $1 \text{ atm} = 1.013 \times 10^5 \text{ Nm}^{-2}$ or $1 \text{ atm} = 101.3 \text{ kPa}$

Table 10.4 Unit of R

Pressere (P)	Volume (V)	Number of moles (n)	Temperture (T)	Gas constant (R)
Pa (pascals)	m^3	mol	K	$8.314 \text{ J K}^{-1} \text{ mol}^{-1}$
atm	dm^3	mol	K	$0.0821 \text{ atm dm}^3 \text{ K}^{-1} \text{ mol}^{-1}$
atm	L	mol	K	$0.0821 \text{ L atm K}^{-1} \text{ mol}^{-1}$

iii. R in calories:

We know, 1 calorie = 4.184 Joules

$$\therefore R = \frac{8.314}{4.184} = 1.987 \cong 2 \text{ cal K}^{-1} \text{ mol}^{-1}$$

While using ideal gas equation one should use consistent units. The most common units are shown in Table 10.4.

10.5.3 Expression for Molar mass :

Ideal gas equation can be used to determine the Molar mass (M) of a compound. Rearranging the equation (10.15)

$$n = \frac{PV}{RT} \dots\dots\dots (10.16)$$

But for a known mass of a gas 'm', the number of moles,

$$n = \frac{m}{M}$$

On substituting this in equation (10.16) we get

$$\frac{m}{M} = \frac{PV}{RT}$$

$$\therefore M = \frac{mRT}{PV} \dots\dots\dots (10.17)$$

10.5.4 Combined Gas law :

The ideal gas equation is written as

$$PV = nRT \dots\dots (10.15)$$

On rearranging Eq. (10.15) we get

$$\therefore \frac{PV}{T} = nR = \text{constant}$$

$$\therefore \frac{P_1V_1}{T_1} = \frac{P_2V_2}{T_2} \dots\dots (10.18)$$

The ideal gas equation used in this form is called **combined gas law**. We have to assume a gas under two different sets of conditions where pressure, volume and temperatures are written for one state as P_1, V_1, T_1 and the other state as P_2, V_2, T_2 , respectively.

Problem 10.3 : A sample of N_2 gas was placed in a flexible 9.0 L container at 300K at a pressure of 1.5 atm. The gas was compressed to a volume of 3.0L and heat was added until the temperature reached 600K. What is the new pressure inside the container?

Given Data : $V_1 = 9 \text{ L}$ $V_2 = 3\text{L}$
 $P_1 = 1.5 \text{ atm}$ $T_2 = 600\text{K}$
 $T_1 = 300 \text{ k}$ $P_2 = ?$

Solution : According to combined gas law equation,

$$\frac{P_1V_1}{T_1} = \frac{P_2V_2}{T_2} \quad \therefore \frac{1.5 \times 9}{300} = \frac{P_2 \times 3}{600}$$

$$\therefore P_2 = 9 \text{ atm}$$

Problem 10.4 : Find the temperature in $^\circ\text{C}$ at which volume and pressure of 1 mol of nitrogen gas becomes 10 dm^3 and 2.46 atmosphere respectively.

Given : $P = 2.46 \text{ atm}$, $V = 10 \text{ dm}^3$,
 $n = 1\text{mol}$, $R = 0.0821 \text{ dm}^3\text{-atmk}^{-1}\text{mol}^{-1}$
 $T = ?$

Solution : Ideal gas equation is

$$PV = nRT$$

$$\therefore T = \frac{PV}{nR} = \frac{2.46 \times 10}{1 \times 0.0821}$$

$$T = 299.63\text{K}$$

$$\text{Temp. in } ^\circ\text{C} = 299.63 - 273.15 = 26.48 \text{ } ^\circ\text{C}$$

10.5.4 Relation between density, molar mass and pressure :

Ideal gas equation can be expressed in terms of density as follows :

$$PV = nRT \dots\dots (10.5)$$

On rearranging it gives

$$\frac{n}{V} = \frac{P}{RT}$$

But we know $n = \frac{m}{M}$

On substituting value of 'n', rearranged equation becomes-

$$\therefore \frac{m}{MV} = \frac{P}{RT} \quad (\text{at constant temperature})$$

$$\therefore \frac{d}{M} = \frac{P}{RT} \quad \dots\dots (10.19)$$

where $\frac{m}{V} = d = \text{density of a gas}$

On rearranging equation (10.19) we get expression to calculate molar mass of a gas in terms of its density.

$$M = \frac{dRT}{P} \quad \dots\dots(10.20)$$

From equation (10.19) **Boyle's law** can be stated in terms of density as : at constant temperature, pressure of a given mass of gas is directly proportional to its density.

10.5.6 Dalton's law of Partial Pressure :

John Dalton not only put forth the atomic theory, but also made several contributions to understanding of the behaviour of gases. He formulated the law of partial pressure in 1801. This law is applicable for those gases which do not react chemically on mixing. The pressure exerted by an individual gas in a mixture of two or more gases is called **partial pressure**. It is also the pressure that each gas would exert if it were present alone. Daltons law of partial pressure is stated as :

The total pressure of a mixture of two or more non reactive gases is the sum of the partial pressures of the individual gases in the mixture.

Mathematically, Dalton's law may be expressed as,

$$P_{Total} = P_1 + P_2 + P_3 + \dots \quad (\text{at constant } V \text{ and } T)$$

Where P_{Total} is the total pressure of the mixture and P_1, P_2, P_3, \dots are the partial pressures of the individual gases 1, 2, 3, in the mixture.

Partial pressure and mol fraction : We know that the pressure of a pure gas is given by the ideal gas equation

$$P = \frac{nRT}{V} \quad \dots (10.21) \quad (V \text{ and } T \text{ are constant})$$

$$\therefore P \propto n.$$

Consequently, the pressure of an individual gas in a mixture of gases is proportional to its amount in that mixture. This implies that the total pressure (P_T) of a mixture of gases at constant volume (V) and Temperature (T) is equal to the sum of the pressure that individual gas exerts in the mixture. This is Dalton's law of partial pressures. It is shown in Fig. 10.13.

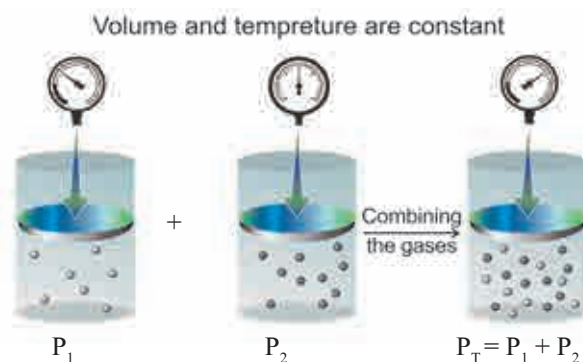

Fig. 10.13 : Schematic illustration of Dalton's law of partial pressures



Just think

Do all pure gases obey all the gas laws? Do the mixtures of gases obey the gas laws? Yes, the gas laws are also applicable to the mixtures of gases. As we have learnt in section 10.5.3 that the measurable properties of mixture of the gases such as pressure, temperature, volume and amount of gaseous mixture are all related by an ideal gas law.

The partial pressures of individual gases can be written in terms of ideal gas equation as follows :

$$P_1 = n_1 \left(\frac{RT}{V} \right), \quad P_2 = n_2 \left(\frac{RT}{V} \right),$$

$$P_3 = n_3 \left(\frac{RT}{V} \right), \dots \text{ and so on } \dots (10.21)$$

$$\therefore P_{Total} = n_1 \left(\frac{RT}{V} \right) + n_2 \left(\frac{RT}{V} \right) + n_3 \left(\frac{RT}{V} \right) \dots\dots$$

$$= \left(\frac{RT}{V}\right)(n_1 + n_2 + n_3 \dots) = \frac{RT}{V} n_{\text{Total}} \dots\dots (10.22)$$

Mole fraction of any individual gas in the mixture is given by the equation

$$X_1 = \frac{n_1}{n_1 + n_2 + n_3 \dots} = \frac{n_1}{n_{\text{Total}}} \dots (10.23)$$

From Eq. (10.21) and Eq. (10.23) we get

$$n_1 = P_1 \left(\frac{RT}{V}\right) \dots (10.24)$$

and

$$n_{\text{Total}} = P_{\text{Total}} \left(\frac{RT}{V}\right) \dots (10.25)$$

By combining equation Eq. (10.24) and Eq. (10.25) we get

$$\frac{n_1}{n_{\text{Total}}} = X_1 = \frac{P_1 \left(\frac{RT}{V}\right)}{P_{\text{Total}} \left(\frac{RT}{V}\right)} = \frac{P_1}{P_{\text{Total}}} \dots\dots (10.26)$$

Therefore it follows that

$$P_1 = X_1 \cdot P_{\text{Total}} \dots\dots (10.27)$$

Similarly,

$$P_2 = X_2 \cdot P_{\text{Total}}, P_3 = X_3 \cdot P_{\text{Total}} \text{ and so on.}$$

Thus partial pressure of a gas is obtained by multiplying the total pressure of mixture by mole fraction of that gas.



Just think

Where is the Dalton's law applicable? The most important gas mixture is of course the air around us. Dalton law is useful for the study of various phenomena in air including air pollution.

Aqueous Tension :A vapor is a gas in contact with a liquid of the same substance. For example, the 'gas' above the surface of liquid water is described as water vapour. The pressure of the water vapour is known as its **vapour pressure**.

Suppose the liquid water is placed into a container and air above is pumped away and

Problem 10.5 : A mixture of 28g N₂, 8 g He and 40 g Ne has 20 bar pressure. What is the partial pressure of each of these gases ?

Solution : Partial pressure mole fraction x total pressure

Step 1 : Determine the number of moles (n) of each gas from its mass (m) and molar mass (M), using the formula $n = \frac{m}{M}$

$$n_{\text{N}_2} = \frac{28 \text{ g}}{28 \text{ g mol}^{-1}} = 1 \text{ mol}$$

$$n_{\text{He}} = \frac{8 \text{ g}}{4 \text{ g mol}^{-1}} = 2 \text{ mol}$$

$$n_{\text{Ne}} = \frac{40 \text{ g}}{20 \text{ g mol}^{-1}} = 2 \text{ mol}$$

Step 2 : Determine the mole fraction of each gas using the formula

$$X_{\text{N}_2} = \frac{n}{n_{\text{Total}}}$$

$$X_{\text{N}_2} = \frac{n_{\text{N}_2}}{n_{\text{N}_2} + n_{\text{He}} + n_{\text{Ne}}} = \frac{1 \text{ mol}}{(1 + 2 + 2) \text{ mol}} = \frac{1}{5}$$

$$X_{\text{He}} = \frac{n_{\text{He}}}{n_{\text{Total}}} = \frac{2 \text{ mol}}{5 \text{ mol}} = \frac{2}{5}$$

$$\text{Similarly } X_{\text{Ne}} = \frac{2}{5}$$

Step 3 : Calculate the partial pressure

$$P_{\text{N}_2} = X \times P_{\text{Total}} = \frac{1}{5} \times 20 \text{ bar} = 4 \text{ bar}$$

$$P_{\text{He}} = X_{\text{He}} \times P_{\text{Total}} = \frac{2}{5} \times 20 \text{ bar} = 8 \text{ bar}$$

$$P_{\text{Ne}} = X_{\text{Ne}} \times P_{\text{Total}} = \frac{2}{5} \times 20 \text{ bar} = 8 \text{ bar}$$

the container is sealed. Then the liquid water evaporates and only water vapour remains in the above space. After sealing, the vapour pressure increases initially, then slows down as some water molecules condense back to form liquid water. After a few minutes, the vapour pressure reaches a maximum called the **saturated vapour pressure**. (We will learn more about in section 10.9.2) The pressure exerted by saturated water vapour is called **Aqueous Tension (P_{aq})**.

When a gas is collected over water in a closed container, it gets mixed with the saturated water vapour in that space. The measured pressure, therefore, corresponds to the pressure of the mixture of that gas and the saturated water vapour in that space.

Pressure of pure and dry gas can be calculated by using the aqueous tension. It is obtained by subtracting the aqueous tension from total pressure of moist gas.

$$\therefore P_{\text{Dry gas}} = P_{\text{Total}} - P_{\text{aq}}$$

i.e. $P_{\text{Dry gas}} = P_{\text{Total}} - \text{Aqueous Tension}$

Table 10.5 : Aqueous Tension of Water (Vapour Pressure) as a function of Temperature

Temp. (K)	Pressure (bar)	Temp. (K)	Pressure (bar)
273.15	0.0060	295.15	0.0260
283.15	0.0121	297.15	0.0295
288.15	0.0168	299.15	0.0331
291.15	0.0204	301.15	0.0372
293.15	0.0230	303.15	0.0418

The above table reflects that Aqueous Tension increases with increase in temperature.

10.6 Kinetic Molecular Theory of Gases :

The kinetic molecular theory of gases is a theoretical model put forth to explain the behavior of gases.

Assumptions of kinetic molecular theory of gases :

1. Gases consist of tiny particles (molecules or atoms).
2. On an average, gas molecules remain far apart from each other. Therefore the actual volume of the gas particles is negligible as compared to the volume of the container. (That is why the gases are highly compressible).
3. The attractive forces between the gas molecules are negligible at ordinary temperature and pressure. (As a result gas expands to occupy entire volume of the container).
4. Gas molecules are in constant random motion and move in all possible directions in straight lines. They collide with each other and with the walls of the container.

5. Pressure of the gas is due to the collision of gas particles with the walls of container.
6. The collisions of the gas molecules are perfectly elastic in nature, which means that the total energy of the gaseous particle remains unchanged after collision.
7. The different molecules of a gas move with different velocities at any instant and hence have different kinetic energies. But average kinetic energy of the gas molecules is directly proportional to the absolute temperature.

Average K.E. $\propto T$

10.7 Deviation from Ideal behaviour : An **ideal gas** is the one that exactly follows the ideal gas equation. On rearranging the ideal gas equation, $n = PV/RT$. If we use 1 mole of any gas then the ratio PV/RT is predicted to have numerical value of 1 at all pressures. If a gas does not obey the ideal gas law, the ratio will be either greater than 1 or less than 1, such a gas is said to be a **Real Gas**.

A. Ideal Gas:

1. A gas that obeys all the gas laws over the entire range of temperature and pressure.
2. There are no interactive forces between the molecules.
3. The molecular volume is negligibly small compared to the volume occupied by the gas. These are point particles.

B. Real Gas :

1. Real gas does not obey Boyle's law and Charles' law under all the conditions of temperature and pressure.

A deviation from the ideal behaviour is observed at **high pressure and low temperature**. It is due to two reasons.

- (1) The intermolecular attractive forces are not negligible in real gases. These do not allow the molecules to collide the container wall with full impact. This results in decrease in the pressure.
- (2) At high pressure, the molecules are very close to each other. The short range repulsive forces start operating and the molecules behave as small but hard spherical particles.

The volume of the molecule is not negligible. Therefore, less volume is available for molecular motion.

At very low temperature, the molecular motion becomes slow and the molecules are attracted to each other due to the attractive force. Hence, here again the behaviour of the real gas deviates from the ideal gas behaviour.

Deviation with respect to pressure can be studied by plotting pressure (P) vs volume (V) curve at a given temperature. (See Fig. 10.14 and Table 10.6).

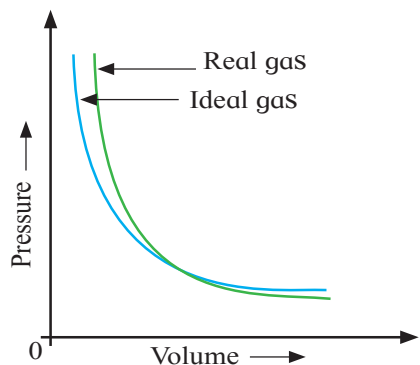

Fig. 10.14 : Plot of pressure Vs volume for real and ideal Gas

At very high pressure, the measured volume is more than theoretically calculated volume assuming ideal behaviour. But at low pressure, measured and calculated volumes approach each other.

Compressibility Factor (Z) : Real Gases show ideal behavior when pressure approaches zero. Deviation from ideal behaviour can be measured in terms of compressibility factor Z which is the ratio of product PV and nRT .

$$Z = \frac{PV}{nRT}$$

Figure 10.15 shows the graph of Z vs P . It is a straight line parallel to x - axis (pressure axis) where $Z = 1$.

For ideal gas $Z = 1$ at all the value of temperature and pressure. The significance of Z is better understood from the following derivation. we can write two equation (10.28) and (10.29) for real and ideal gas respectively.

$$Z = \frac{PV_{real}}{nRT} \quad \dots\dots (10.28)$$

$$\text{and } 1 = \frac{PV_{ideal}}{nRT} \quad \dots\dots (10.29)$$

$$\therefore \frac{P}{nRT} = \frac{1}{V_{ideal}}$$

Substituting the value of $\frac{P}{nRT}$ in Eq. (10.28), we get

$$Z = \frac{V_{real}}{V_{ideal}} \quad \dots\dots (10.30)$$

Table 10.6 : Difference between Ideal Gas and Real Gas

Ideal gas	Real Gas
1. Strictly obeys Boyle's and Charles' law. $\frac{PV}{nRT} = 1$	1. Shows deviation from Boyle's and Charles' law at high pressure and temperature. i.e. obeys Boyle's law and Charles' law at low pressure and high temperature. $\frac{PV}{nRT} \neq 1$
2. Molecules are perfectly elastic.	2. Molecules are not perfectly elastic.
3. No attraction or repulsion between the gas molecules i.e. collision without loss of kinetic energy (K.E.)	3. Intermolecular attraction is present, hence collision takes place with loss of kinetic energy.
4. Actual volume of the gas molecules is negligible as compared to total volume of the gas.	4. Actual volume of individual gas molecule is significant at high pressure and low temperature.
5. Can not liquify even at low temperature but continues to obey Charles' law and finally occupies zero volume at -273°C .	5. Undergo liquefaction at low temperature when cooled and compressed.
6. Such a gas does not exist.	6. Gases that exist in nature like H_2 , O_2 , CO_2 , N_2 , He, etc.

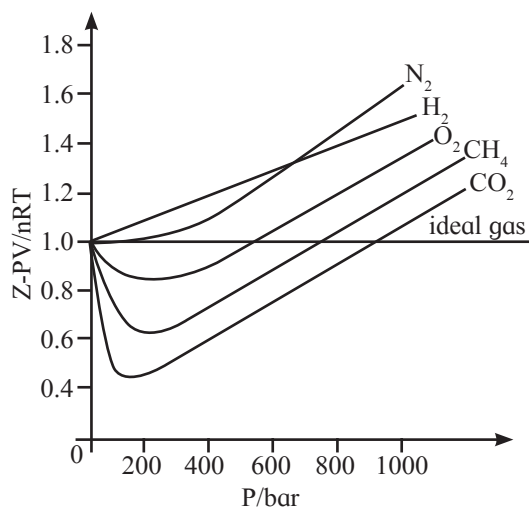

Fig. 10.15 : Graph of compressibility factor Z versus pressure for some gases

The Eq.(10.30) implies that the compressibility factor is the ratio of actual molar volume of a gas to its molar volume if it behaved ideally, at that temperature and pressure.

A positive deviation in Z , ($Z > 1$), means that the volume of a molecule cannot be neglected and the gas is difficult to compress. **At lower pressure**, the gases have $Z = 1$ or $Z < 1$. Under this condition the molecular volume is negligible and the gases are compressible. Here, the gases show ideal behaviour.

10.8.3 Liquefaction of gases and critical constant : Most gases behave like ideal gases at high temperature. For example, the PV curve of CO_2 gas at 50°C is like the ideal Boyle's law curve. As the temperature is lowered the PV curve shows a deviation from the ideal Boyle's law curve. At a particular value of low temperature the gas gets liquified at certain increased value of pressure. For example, CO_2 gas liquifies at 38.98°C and 73 atmosphere pressure (See Fig. 10.16).

This is the highest temperature at which liquid CO_2 can exist. Above this temperature, however large the pressure may be, liquid CO_2 cannot form. Other gases also show similar behaviour.

The temperature above which a substance cannot be liquified by increasing pressure is called its critical temperature (T_c).

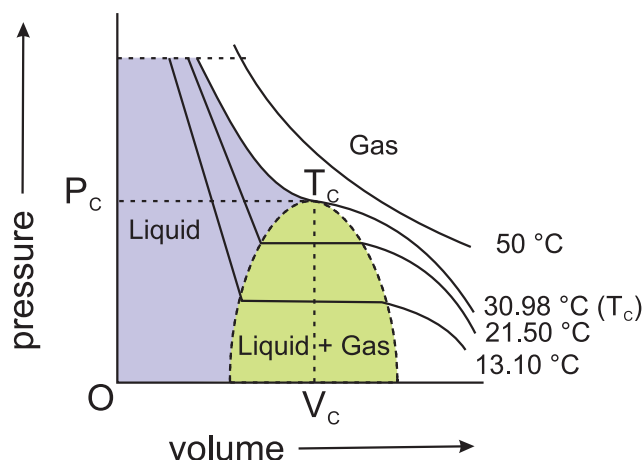

Fig. 10.16 : Liquefaction of CO_2 : Isotherms at various temperature

Above the critical temperature a substance exists only as gas. **The molar volume at critical temperature is called the critical volume (V_c), and the pressure at the critical temperature is called the critical pressure (P_c)** of that substance. The Table 10.7 gives the values of these three critical constants for some common gases.

Table 10.7 : Critical constants for common Gases

Substance	T_c / K	P_c / bar	$V_c / \text{dm}^3 \text{mol}^{-1}$
H_2	33.2	12.97	0.0650
He	5.3	2.29	0.0577
N_2	126.0	33.9	0.0900
O_2	154.3	50.4	0.0744
CO_2	304.10	73.9	0.0956
H_2O	647.1	220.6	0.0450
NH_3	405.5	113.0	0.0723

From the Table 10.7 it is seen that the gases that we come across in everyday life, namely, N_2 and O_2 , have T_c values much below 0°C and their P_c values are high. Consequently, liquefaction of O_2 and N_2 (and air) requires compression and cooling.

The T_c value of CO_2 nearly equals the room temperature, however, its P_c value is very high. Therefore CO_2 exists as gas under ordinary condition.

Problem 10.5 : Water has $T_c = 647.1 \text{ K}$ and $P_c = 220.6 \text{ bar}$. What do these values imply about the state of water under ordinary conditions?

Solution : The T_c and P_c values of water are very high compared to the room temperature and common atmospheric pressure. Consequently water exists in liquid state under ordinary condition of temperature and pressure.

Study of PV curves of various gases at different temperatures reveals that under certain conditions the substance changes completely from gaseous to liquid state or liquid to gaseous state, without having the coexistence of two states. In other words, there is a continuity between the gaseous and liquid state. This continuity is recognized by using the term **Fluid** for either gas or liquid. Under these conditions liquid is just a very dense gas. Liquid and gas can be distinguished from each other only when the fluid is at a temperature below T_c .



Remember

When a liquid, which is exposed to atmosphere, is heated, its vapour pressure increases. Eventually it becomes equal to the atmospheric pressure. At this temperature the vaporisation takes place throughout the bulk of the liquid, and the vapour formed escapes freely, into the surroundings. We call this **boiling point** of the liquid. The boiling temperature (boiling point) depends upon the pressure to which the surface of the liquid is exposed. If the pressure is **1 atm**, the boiling temperature is called **normal boiling point**. If the pressure is **1 bar**, the boiling temperature is called **standard boiling point**.

For water: normal b.p. = 100°C , standard b.p. = 99.6°C

Problem 10.6

CO_2 has $T_c = 38.98^\circ\text{C}$ and $P_c = 73 \text{ atm}$. How many phases of CO_2 coexist at (i) 50°C and 73 atm , (ii) 20°C and 50 atm .

Solution:

(i) 50°C and 73 atm represent a condition for CO_2 above its T_c . Therefore, under this condition CO_2 exists only as single phase.

(ii) 20°C and 50 atm represent a condition for CO_2 below its T_c . Therefore, under this condition two phases of CO_2 , namely, liquid and gas can coexist

Problem 10.7 : In which of the following cases water will have the highest and the lowest boiling point ?

Water is boiled

- in an open vessel,
- in a pressure cooker,
- in a evacuated vessel.

Solution : Higher the pressure to which a liquid is exposed, higher will be its boiling point. The pressure to which water is exposed is maximum in the pressure cooker and minimum in the evacuated vessel. Therefore b.p. of water is highest in (b) and lowest in (c).



Internet my friend

- [https://chem.libretexts.org>bookshelves. Gas laws : overview](https://chem.libretexts.org>bookshelves.Gas%20laws%3Aoverview)
- Collect information about State of Mater

10.9 Liquid state : Liquid state is the intermediate state between solid state and gaseous state. Molecules of liquid are held together by moderately strong intermolecular forces and can move about within the boundary of the liquid. As a result, liquid possesses properties such as fluidity, definite volume and ability to take shape of the bottom of the container in which it is placed. Different liquids are characterized by their quantitative properties such as density, boiling point, freezing point, vapour pressure, surface tension and viscosity. We will look at some of these properties in the following sections.

10.9.1 : Vapour Pressure : Molecules of liquid have a tendency to escape from its surface to form vapour about it. This called evaporation. When a liquid is placed in a closed container. It undergoes evaporation and vapours formed undergo condensation. At equilibrium, the rate of evaporation and rate of condensation are equal. The pressure exerted by the vapour in equilibrium with the liquid is known as **saturated vapour pressure** or simply **vapour pressure**.

The vapour pressure of water is also called **Aqueous Tension**. (Refer to Table 10.5) Schematically vapour pressure is explained in Fig. 10.17.

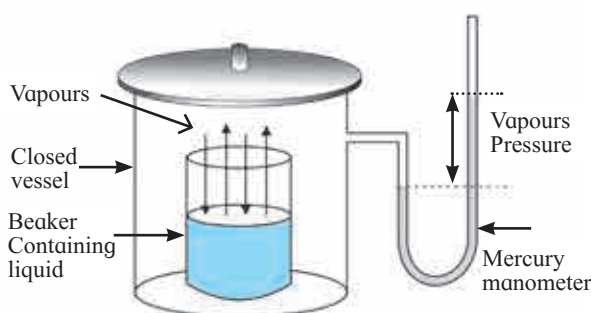

Fig. 10.17 : Vapour pressure of a liquid

Factors affecting vapour pressure :

a. Nature of liquid : Liquids having relatively weak intermolecular forces possess high vapour pressure. These are called volatile liquids. For example, petrol evaporates quickly than motor oil.

b. Temperature : When the liquid is gradually heated, its temperature rises and its vapour pressure increases.

Unit : Vapour pressure is measured by means of a manometer. The most common unit for vapour pressure is torr. $1 \text{ torr} = 1 \text{ mm Hg}$. For example, water has a vapour pressure of approximately 20 torr at room temperature. (Refer to section 10.5.6 and Table 10.5)



Just think

What makes the oil rise through the wick in an oil lamp ?



10.9.2 Surface Tension : Many phenomena such as capillary rise of liquids, spherical shapes of liquid drops are due to the property of liquids called **surface tension**. Surface of a liquid acts as a stretched membrane. The particles in the bulk of liquid are uniformly attracted in all directions and the net force acting on the molecules present inside the bulk is zero. But the molecules at the surface experience a net attractive force towards the interior of the liquid, or the forces acting on the molecules on the surface are imbalanced (see Fig.10.18). Therefore, liquids have a tendency to minimize their surface area.

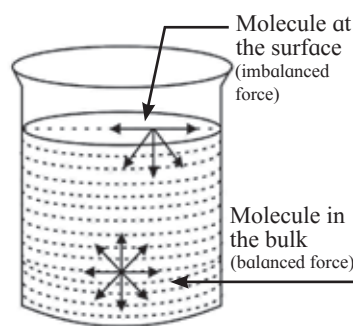

Fig. 10.18 : Imbalance of forces at the surface of a liquid

Surface tension is a temperature dependent property. When attractive forces are large, surface tension is large. Surface tension decreases as the temperature increases. With increase in temperature, kinetic energy of molecules increases. So intermolecular forces of attraction decrease, and thereby surface tension decreases.

The force acting per unit length perpendicular to the line drawn on the surface of liquid is called surface tension.

Unit : Surface tension is measured in SI Unit, Nm^{-1} , denoted by Greek letter " γ " (Gamma)

Application of surface tension :

i. Cleaning action of soap and detergent is due to the lowering of interfacial tension between water and oily substances. Due to lower surface tension, the soap solution penetrates into the fibre, surrounds the oily substance and washes it away.

ii. Efficacy of toothpastes, mouth washes and nasal drops is partly due to presence of substances having lower surface tension. This increases the efficiency of their penetrating action.

10.9.3 Viscosity : As noted earlier, liquids (fluids) have a tendency to flow. Viscosity measures the magnitude of internal friction in a liquid or fluid to flow as measured by the force per unit area resisting uniform flow, different layers of a liquid flow with different velocity. This called **laminar flow**. Here, the layers of molecules in the immediate contact of the fixed surface remains stationary. The subsequent layers slip over one another. Strong intermolecular forces obstruct the layers from slipping over one another, resulting in a friction between the layers.

Viscosity is the force of friction between the successive layers of a flowing liquid. It is also the resistance to the flow of a liquid.

When a liquid flows through a tube, the central layer has the highest velocity, whereas the layer along the inner wall in the tube remains stationary. This is a result of the viscosity of a liquid (see Fig. 10.19). Hence, a velocity gradient exists across the cross-section of the pipe/tube.

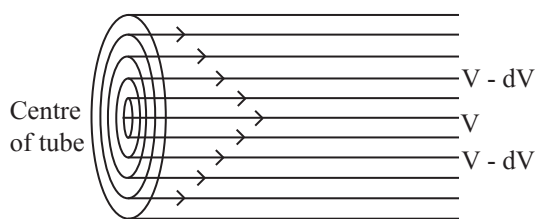

Fig. 10.19 : Laminar flow of a liquid (fluid) through a tube/pipe

Viscosity is a temperature dependent property.

$$\text{Viscosity} \propto \frac{1}{\text{Temp.}}$$

Viscosity also depends on molecular size and shape. Larger molecules have more viscosity and spherical molecules offer the least resistance to flow and therefore are less viscous. Greater the viscosity, slower is the liquid flow.

Unit : Viscosity is expressed in terms of **coefficient of viscosity, ‘η’ (Eta)**. It is defined as the degree to which a fluid resists flow under an applied force, measured by the tangential frictional force per unit area per unit velocity gradient when the flow is laminar.

SI unit of viscosity coefficient is N s m^{-2} (newton second per square meter). In CGS system the unit (η) is measured in poise.

$$1 \text{ poise} = 1 \text{ gm cm}^{-1}\text{s}^{-1} = 10^{-1} \text{ kg m}^{-1}\text{s}^{-1}$$

Illustration of viscosity :

- Lubricating oils are viscous liquids. Gradation of lubricating oils is done on the basis of viscosity. A good quality Lubricating oil does not change its viscosity with increase or decrease in temperature.
- Increase blood viscosity than the normal value is taken as an indication of cardiovascular disease.
- Glass panes of old buildings are found to become thicker with time near the bottom. This is one evidence which indicates that glass is not a solid but a supercooled viscous liquid.



Internet my friend

<https://www.britannica.com/science/viscosity>



Exercises

1. Select and write the most appropriate alternatives from the given choices.

- A. The unit of viscosity is
 a. dynes b. newton
 c. gram d. poise
- B. Which of the following is true for 2 moles of an ideal gas ?
 a. $PV = nRT$ b. $PV = RT$
 c. $PV = 2RT$ d. $PV = T$
- C. Intermolecular forces in liquid are -
 a. greater than gases
 b. less than solids
 c. both a and b
 d. greater than solids
- D. Interactive forces are in ideal gas.
 a. nil b. small
 c. large d. same as that of real gases
- E. At constant temperature the pressure of 22.4 dm^3 volume of an ideal gas was increased from 105 kPa to 210 kPa, New volume could be-
 a. 44.8 dm^3 b. 11.2 dm^3
 c. 22.4 dm^3 d. 5.6 dm^3

2. Answer in one sentence.

- A. Name the term used for mixing of different gases by random molecular motion and frequent collision.
- B. The pressure that each individual gas would exert if it were alone in the container, what do we call it as ?
- C. When a gas is heated the particles move more quickly. What is the change in volume of a heated gas if the pressure is kept constant ?
- D. A bubble of methane gas rises from the bottom of the North sea. What will happen to the size of the bubble as it rises to the surface ?
- E. Convert the following temperatures from degree celcius to kelvin.
 a. -15° C b. 25° C
 c. -197° C d. 273° C

- F. Convert the following pressure values into Pascals.
 a. 10 atmosphere c. 107000 Nm^{-2}
 b. 1 kPa. d. 1 atmosphere
- G. Convert :
 a. Exactly 1.5 atm to pascals
 b. 89 kPa to newton per square metre (Nm^{-2})
 c. 101.325 kPa to bar
 d. -100° C to kelvin
 e. 0.124 torr to standard atmosphere
- H. If density of a gas is measured at constant temperature and pressure then which of the following statement is correct ?
 a. Density is directly proportional to molar mass of the gas.
 b. Greater the density greater is the molar mass of the gas.
 c. If density, temperature and pressure is given ideal gas equation can be used to find molar mass.
 d. All the above statements are correct.
- I. Observe the following conversions.

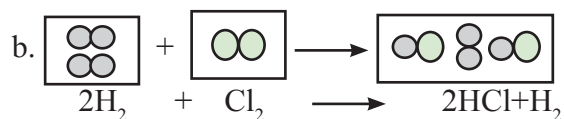
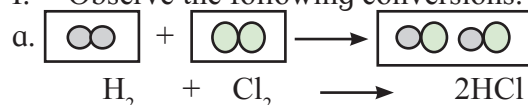

Which of the above reactions is in accordance with the principle of stoichiometry ?

- J. Hot air balloons float in air because of the low density of the air inside the balloon. Explain this with the help of an appropriate gas law.



3. Answer the following questions.

A. Identify the gas laws from the following diagrams.

Diagrams Gas laws

a. 

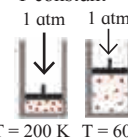
b. 

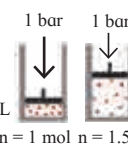
c. 

B. Consider a sample of a gas in a cylinder with a movable piston.

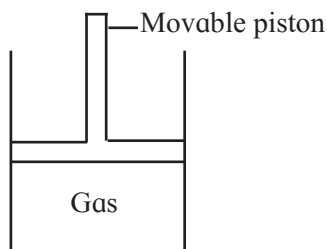

Show diagrammatically the changes in the position of piston, if -

- Pressure is increased from 1.0 bar to 2.0 bar at constant temperature.
 - Temperature is decreased from 300 K to 150 K at constant pressure
 - Temperature is decreased from 400 K to 300 K and pressure is decreased from 4 bar to 3 bar.
- D. List the characteristic physical properties of the gases.
- E. Define the terms:
- Polarizability
 - Hydrogen bond
 - Aqueous tension
 - Dipole moment
- F. Would it be easier to drink water with a straw on the top of the Mount Everest or at the base? Explain.
- G. Identify type of the intermolecular forces in the following compounds.
- $\text{CH}_3 - \text{OH}$
 - $\text{CH}_2 = \text{CH}_2$
 - CHCl_3
 - CH_2Cl_2

H. Name the types of intermolecular forces present in Ar, Cl_2 , CCl_4 and HNO_3

I. Match the pairs of the following :

'A' 'B'

- | | |
|-----------------|------------------------------------|
| a. Boyle's law | i. at constant pressure and volume |
| b. Charles' law | ii. at constant temperature |
| | iii. at constant pressure |

J. Write the statement for :

(a) Boyle's law (b) Charles' law

K. Differentiate between Real gas and Ideal gas.

4. Answer the following questions

A. State and write mathematical expression for Dalton's law of partial pressure and explain it with suitable example.

B. Derive an Ideal gas equation. Mention the terms involved in it. Also write how it is utilised to obtain combined gas law.

C. With the help of graph answer the following -

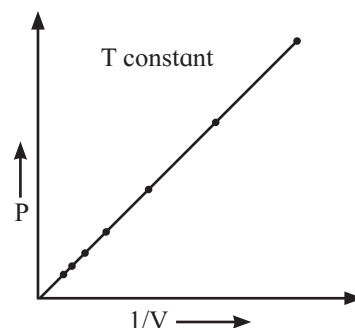

At constant temperature,

- Graph shows relation between pressure and volume. Represent the relation mathematically.
 - Identify the law.
 - Write the statement of law.
- D. Write Postulates of kinetic theory of gases.
- E. Write a short note on -
- Vapour pressure.
 - Surface tension
 - Viscosity.

5. Solve the following

A. A balloon is inflated with helium gas at room temperature of 25°C and at 1 bar pressure when its initial volume is 2.27L and allowed to rise in air.

As it rises in the air external pressure decreases and the volume of the gas increases till finally it bursts when external pressure is 0.3bar. What is the limit at which volume of the balloon can stay inflated ? (Ans:7.567L)

- B. A syringe has a volume of 10.0 cm^3 at pressure 1 atm. If you plug the end so that no gas can escape and push the plunger down, what must be the final volume to change the pressure to 3.5 atm?



(Ans: 2.9 cm^3)

- C. The volume of a given mass of a gas at 0°C is 2 dm^3 . Calculate the new volume of the gas at constant pressure when

a. The temperature is increased by 10°C .

(Ans: 2.07 dm^3)

b. The temperature is decreased by 10°C .

(Ans: 1.93 dm^3)

- D. A hot air balloon has a volume of 2800 m^3 at 99°C . What is the volume if the air cools to 80°C ?

(Ans: 2657 m^3)



- E. At 0°C , a gas occupies 22.4 liters. How much hot must be the gas in celsius and in kelvin to reach volume of 25.0 literes?

(Ans: $31.7^\circ\text{C}/304.9 \text{ K}$)

- F. A 20 L container holds 0.650 mol of He gas at 37°C at a pressure of 628.3 bar. What will be new pressure inside the container if the volume is reduced to 12 L. The temperature is increased to 177°C and 1.25 mol of additional He gas was added to it?

(Ans: 4443 bar/5.85atm)

- G. Nitrogen gas is filled in a container of volume 2.32 L at 32°C and 4.7 atm pressure. Calculate the number of moles of the gas.

(Ans: 0.436 moles)

- H. At 25°C and 760 mm of Hg pressure a gas occupies 600 mL volume. What will be its pressure at the height where temperature is 10°C and volume of the gas 640 mL ?

(Ans : 676.6 mm Hg)

- I. A neon-dioxygen mixture contains 70.6 g dioxygen and 167.5g neon. If pressure of the mixture of the gases in the cylinder is 25 bar. What is the partial pressure of dioxygen and neon in the mixture?

(Ans: $p_{\text{O}_2} = 5.25 \text{ bar}$, $p_{\text{Ne}} = 19.75 \text{ bar}$)

- J. Calculate the pressure in atm of 1.0 mole of helium in a 2.0 dm^3 container at 20.0°C .

(Ans: 12.02 atm)

- K. Calculate the volume of 1 mole of a gas at exactly 20°C at a pressure of 101.35 kPa.

(Ans: 24.055 dm^3)

- L. Calculate the number of molecules of methane in 0.50 m^3 of the gas at a pressure of $2.0 \times 10^2 \text{ kPa}$ and a temperature of exactly 300 K.

(Ans: 2.4×10^{25})



Activity :

Perform different activities related to concepts mentioned in chapter.

11. Adsorption and Colloids

11.1 Introduction : When a metal spoon is dipped in milk and taken out, you will notice that a film of milk particles cover the spoon surface. If a cold water bottle is taken out from the refrigerator and kept on a table for a while, water vapour is seen to condense on the outer surface of the bottle, forming droplets or a film. Here the milk particles or the water molecules from the air get adsorbed on the surface, namely, the spoon and the bottle. Many a surfaces of objects around us are exposed to the atmosphere. Water molecules as well as other gas molecules such as N_2 , O_2 , from the air form an invisible multi molecular film on these objects. This is known as the phenomenon of adsorption.

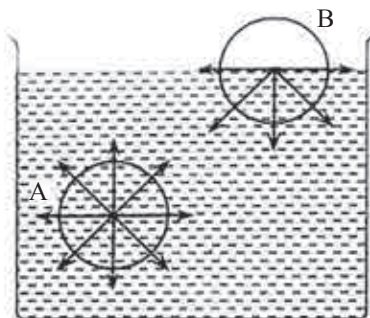

A - Bulk molecule
B - Surface molecule

Fig 11.1 Unbalanced forces

11.2.1 Adsorption : Consider a surface of liquid or solid. The molecular forces at the surface of a liquid are unbalanced or in unsaturation state. In solids, the ions or molecules at the surface of a crystal do not have their forces satisfied by the close contact with other particles.

Because of the unsaturation solid and liquid surfaces tend to attract gases or dissolved substances with which they come in close contact. Thus the substance accumulates on the surface of solid or liquid.



Can you tell?

What is adsorption ?

11.2.2 Why does adsorption occur?

The adsorption phenomenon is caused by dispersion forces (also known as London dispersion forces), or van der Waals forces. These are short range and additive. The adsorption force is the sum of all interactions between all the atoms. The pulling interactions cause the surface of a liquid to tighten like an elastic film. A measure of the elastic force at the surface of a liquid is called surface tension. (Refer to Chapter 10).

The surface tension is the amount of energy required to stretch or increase the surface of a liquid by a unit area. There is a tendency to have minimum surface tension that is, decrease of free energy, which leads to adsorption. Terms involved in adsorption :

Adsorbent : The material or substance present in the bulk, on the surface of which adsorption takes place is called adsorbent.

Adsorbate : The substance getting absorbed on the the adsorbent is called as adsorbate.

11.2.3 Examples of Adsorption: You know that when cotton is dipped in water, cotton becomes wet with water which is due to absorption.

Some more examples of adsorption :

- Adsorption of gases like hydrogen, oxygen, by finely divided metals, namely, platinum, palladium, copper, nickel, etc.
- Adsorption of gases like nitrogen, carbondioxide, by activated charcoal.
- Removal of colouring matter like an organic dye, for example methylene blue. When charcoal is added to methylene blue solution and shaken, it becomes colourless after some time, as dye molecules accumulate on the surface of charcoal.

Table 11.1 shows comparison between adsorption and absorption.

11.2.4 Desorption: The process of removal of an adsorbed substance from a surface on which it was adsorbed is called desorption.

Table 11.1 : Comparison between Adsorption and Absorption

Adsorption	Absorption
1. Adsorbed matter is concentrated only at the surface and does not penetrate through the surface to the bulk of adsorbent. Adsorption is a surface phenomenon.	Absorbed matter is uniformly distributed inside as well as at the surface of the bulk of substance. Absorption is a bulk phenomenon.
2. Concentration of the adsorbate is high only at the surface of the adsorbent.	Concentration of the absorbate is uniform throughout the bulk of the absorbent.
3. It is dependent on temperature and pressure.	It is independent of temperature and pressure.
4. It is accompanied by evolution of heat known as heat of adsorption.	It is not accompanied by any evolution or absorption of heat.
5. It depends on surface area	It is independent of surface area.
6. Example: Adsorption of a gas or liquid like acetic acid by activated charcoal	Example : Absorption of water by cotton. Absorption of ink by blotting paper.



Try this

Dip a chalk in ink. What do you observe ?

11.2.5 Sorption: When a chalk is dipped in ink, ink molecules are adsorbed at the surface of chalk and the surface becomes coloured, while the solvent of the ink goes deeper into the chalk due to absorption. When, both adsorption and absorption occur simultaneously it is known as sorption.

11.3 Types of adsorption: There are mainly two types of adsorption phenomenon depending on nature of forces involved.

11.3.1 Physical Adsorption or physisorption:

When the adsorbent such as gas molecules are accumulated at the surface of a solid on account of weak van der Waals forces, the adsorption is termed as physical adsorption or physisorption.

The van der Waals forces, are similar to forces causing condensation of gas into liquid. Thus, heat is released in physisorption. The heat released during physisorption is of the same order of magnitude as heat of condensation. Due to weak nature of van der Waals forces, physisorption is also weak in nature. The adsorbed gas forms several layers of molecules at high pressures. The extent of adsorption is large at low temperatures. The equilibrium is attained rapidly. The physisorption is readily reversed by lowering of pressure of gas or by raising temperature.

11.3.2 Chemical Adsorption or Chemisorption :

Chemisorption was first investigated in 1916 by American Chemist, **Irving Langmuir** (1881-1957). When the gas molecules accumulate at the surface of a solid or adsorbate by means of chemical bonds, be it covalent or ionic, the adsorption is called chemical adsorption (or chemisorption). Chemisorption is specific in nature. Chemisorption involving the gas-solid as the adsorbate and adsorbent, is usually exothermic. It means that heat is released during this process. (Exception : the adsorption of hydrogen on glass is endothermic : heat is absorbed during the process. This is due to dissociation of hydrogen.) The heat evolved in chemisorption per mole of adsorbate is nearly the same order of magnitude as that accompanying chemical bonding. Chemisorption involves a large energy of activation and referred as activated adsorption. Chemisorption increases with increase in temperature in the beginning, as more number of molecules can have activation energy. But after certain temperature chemisorption decreases with increase in temperature, as the chemical bonds break.

Sometimes at low temperature, physisorption occurs which passes into chemisorption as the temperature is raised. Besides, chemisorption is dependent on surface area of the adsorbent (See Table 11.2).

Table 11.2 : Comparison of physisorption and chemisorption

Physisorption	Chemisorption
1. The forces operating are weak van der Waals forces.	1. The forces operating are of chemical nature (covalent or ionic bonds).
2. Not specific in nature. All gases adsorb on all solids. For example, all gases adsorb on charcoal.	2. Highly specific and occurs only when chemical bond formation is possible between adsorbent and adsorbate. For example, adsorption of oxygen on tungsten, hydrogen on nickel, etc.
3. The heat of adsorption is low and lies in the range 20 - 40 kJ mol ⁻¹	3. Higher heat of adsorption and lies in the range 40 - 200 kJ mol ⁻¹
4. Occurs at the low temperature and decreases with an increase of temperature.	4. Favoured at high temperature, the extent of chemical adsorption is lowered at very high temperature, due to bond breaking.
5. For example : at low temperature N ₂ gas is physically adsorbed on iron.	5. For example N ₂ gas chemically adsorbed on iron at high temperature forms a layer of iron nitride, which desorbs at very high temperature.
6. Reversible.	6. Irreversible.
7. Physisorbed layer may be multimolecular layer, of adsorbed particles under high pressure.	7. Chemisorption forms monomolecular layer of adsorbed particles.

11.4 Factors affecting adsorption of gases on solids : All solids adsorb gases to some extent. The extent of adsorption depends upon a number of factors discussed in this section.

1. Nature of adsorbate (gas) : The amount of gas adsorbed by a solid depends on the nature of the gas. Gases having high critical temperature liquify easily and can readily be adsorbed. (Refer to chapter 10). The gases such as SO₂, Cl₂, NH₃ which are easily liquifiable are adsorbed to a large extent compared to N₂, O₂, H₂ etc, which are difficult to liquify.

Table 11.3 : Critical temperature of gases and volume adsorbed

Gas	Critical temperature/K	Volume adsorbed/cm ³
N ₂	126	08
HCl	324	72
NH ₃	406	181
Cl ₂	417	235
SO ₂	430	380

2. Nature of adsorbent: Substances which provide large surface area for a given mass are effective as adsorbents and adsorb appreciable volumes of gases. Silica gel, charcoal are effective adsorbents due to their porous nature.

3. Surface area of adsorbent : Adsorption is a surface phenomenon. Hence, the extent of adsorption increases with increase in surface area of adsorbent. Finely divided substances, rough surfaces, colloidal substances are good adsorbents as they provide larger surface area for a given mass.

4. Temperature : Adsorption is an exothermic process. According to Le-Chatelier's principle (Chapter 12), it is favoured at low temperature. The amount of gas adsorbed is, thus, inversely proportional to temperature.

Figure 11.2 shows plots of volume of N₂ adsorbed per unit mass of adsorbent against the pressure of a gas at different temperatures. As temperature increases from 193 K to 273 K at a constant pressure 'P' the amount of gas adsorbed decrease.

5. Pressure of gas : At any temperature, the extent of gas adsorbed increases with an increase of pressure. The extent of adsorption is directly proportional to pressure of the gas. At high pressures extent of adsorption becomes independent of the pressure. The surface of adsorbent is, then, almost fully covered by adsorbed gaseous molecules.

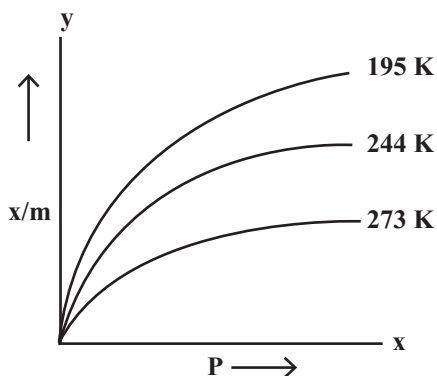

Fig 11.2 Variation of adsorption with temperature and pressure

11.5 Adsorption Isotherm : The relationship between the amount of a substance adsorbed per unit mass of adsorbent and the equilibrium pressure (in case of gas) or concentration (in case of solution) at a given constant temperature is called an adsorption isotherm. Various adsorption isotherms are known.

Freundlich adsorption isotherm : Freundlich proposed an empirical equation for adsorption of a gas on solid.

$$\frac{x}{m} = k P^{1/n} \quad (n > 1) \quad \dots\dots (11.1)$$

Where x = mass of the gas adsorbed

m = mass of the adsorbent at pressure P

$\frac{x}{m}$ = mass of gas adsorbed per unit mass of adsorbent

P = equilibrium pressure.

k and n are constants which depend on the nature of adsorbate, adsorbent and temperature.

Graphical Representation of Freundlich equation.

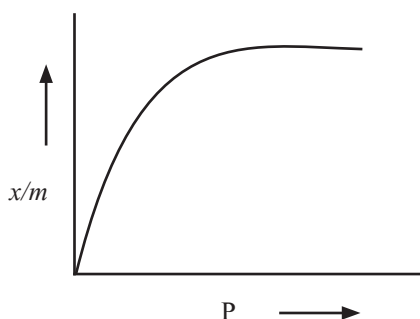

Fig 11.3 Adsorption isotherm

In case of solution, P in the Eq. (11.1) is replaced by the concentration and thus

$$\frac{x}{m} = kC^{1/n} \quad \dots\dots (11.2)$$

After taking logarithm of the above Eq. 11.2

$$\log \frac{x}{m} = \log k + \frac{1}{n} \log C \quad \dots\dots (11.3)$$

Plotting $\log \frac{x}{m}$ against $\log C$ or $\log P$, a straight line is obtained which is shown in Fig.11.4.

The slope of the straight line gives $\frac{1}{n}$. While intercept on y-axis gives $\log k$. The factor $\frac{1}{n}$ ranges from 0 to 1. Equation (11.3) holds good over limited range of pressures.

When $\frac{1}{n} \rightarrow 0$, $\frac{x}{m} \rightarrow$ constant, the adsorption, then, is independent of pressure.

When $\frac{1}{n} = 1$, $\frac{x}{m} = kP$. i.e. $\frac{x}{m} \propto P$ the adsorption varies directly with pressure. The experimental isotherms as in Fig. 11.3 tend to saturate at the high pressure.

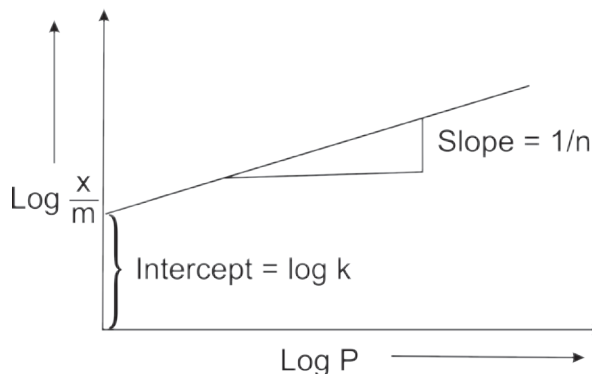

Fig. 11.4 : Freundlich isotherm

11.6 Applications of Adsorption :

The adsorption finds large number of applications as illustrated here.

- i. **Catalysis:** Heterogeneous catalysis : The solid catalysts are used in many industrial manufacturing processes. For example, iron is used as the catalyst in manufacturing of ammonia; platinum in manufacturing of sulphuric acid, H_2SO_4 (by contact process); in hydrogenation of oils, finely divided nickel is employed as catalyst.

- ii. **Gas masks:** It is a device which consists of activated charcoal or mixture of adsorbents. It is used for breathing in coal mines to avoid inhaling of the poisonous gases.
- iii. **Control of humidity :** Silica and alumina gels are good adsorbents of moisture.
- iv. **Production of high vacuum :** Lowering of temperature at a given pressure, increases the rate of adsorption of gases on charcoal powder. By using this principle, high vacuum can be attained by adsorption. A vessel evacuated by vacuum pump is connected to another vessel containing coconut charcoal cooled by liquid air. The charcoal adsorbs the remaining traces of air or moisture to create a high vacuum.
- v. **Adsorption Indicators :** The adsorption is used to detect the end point of precipitation titrations. Dyes such as eosin, fluorescein are used as indicators. For example, A solution of sodium chloride containing a small amount of fluorescein is titrated against silver nitrate solution.

$$\text{NaCl} + \text{AgNO}_3 \rightarrow \text{AgCl} + \text{NaNO}_3$$

White ppt

 When chloride ions are over, fluorescein is adsorbed on white silver chloride precipitate, red colour is developed. Thus colour change from pale yellow to reddish pink can be observed at the end point.
- vi. **Separation of inert gases :** In a mixture of noble gases, different gases adsorb to different extent. Due to selective adsorption principle, gases can be separated on coconut charcoal.
- vii. **Froth floatation process :** A low grade sulfide ore is concentrated by separating it from silica and other earthy matter using pine oil as frothing agent. Hydrophobic pine oil preferentially wets (adsorbs on) sulfide ore which is taken up in the froth.
- viii. **Chromatographic analysis :** It is based on selective adsorption of ions from solution using powdered adsorbents such as silica or alumina gel. It has several

industrial and analytical applications. Other applications include surface area determination, purification of water, etc.

11.7 Catalysis : Catalysts are of importance in chemical industry and in living organisms. A large number of the chemicals manufactured in industries make use of catalysts to obtain specific products, The use of catalyst lowers the reaction temperature, and energy costs significantly.

A **catalyst** thus can be defined as a **substance which when added to a reacting system increases the rate of a reaction without itself undergoing any permanent chemical change.** Catalysis is of two types, namely homogeneous and heterogeneous catalysis.

11.7.1 Homogeneous Catalysis : When the reactants and the catalyst are in the same phase, it is said to be homogeneous catalysis.

Examples of homogeneous catalysis:

- i. Iodide ion (I^-) finds use as homogeneous catalyst in decomposition of aqueous hydrogen peroxide (Both I^- and H_2O_2 are present in the same aqueous phase)
- ii. Oxidation of sulfur dioxide to sulfur trioxide with dioxygen (O_2) in the presence of nitric oxide as catalyst (lead chamber process).

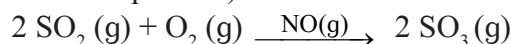

- iii. Hydrolysis of sugar is catalysed by H^+ ion furnished by sulphuric acid.

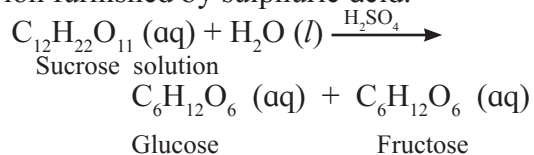

All reactants and catalyst are in same solution phase.

- iv. Enzyme catalysis is also an important type of homogeneous catalysis.

11.7.2 Heterogeneous Catalysis : When the reactant and catalyst are in different phase, it is said to be heterogeneous catalysis.

The heterogeneous catalyst is generally a solid and the reactants may either be gases

or liquids. The solid catalyst is added to the reaction mixture. It does not dissolve in the reacting system. The reaction occurs on surface of solid catalyst.

Examples of heterogeneous catalysis:

- Dinitrogen (N_2) and dihydrogen (H_2) combine to form ammonia in Haber process in presence of finely divided iron along with K_2O and Al_2O_3 .

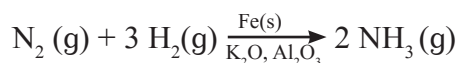

Here Al_2O_3 and K_2O are promoters of the Fe catalyst. Al_2O_3 is added to prevent the fusion of Fe particles. K_2O causes chemisorption of nitrogen atoms. Molybdenum is also used as promoter.

- Hydrogenation reaction of vegetable oils to produce solid fat is used in food industry. The reaction is catalysed by finely divided metals like Ni, Pd or Pt. Vegetable oil contains one or more carbon carbon double bonds ($C=C$) in its structure. On hydrogenation a solid product (which contains only carbon carbon single bonds) is formed. It is called *vanaspati ghee*.

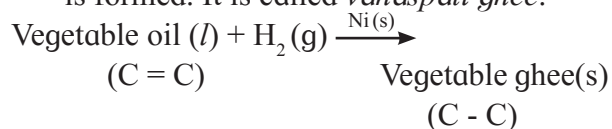

- Another important application of heterogeneous catalysts is in automobile catalytic converters. In automobile exhaust, large number of air pollutants such as carbon monoxide, nitric oxide, etc. are present. The catalytic converter transforms the air pollutants into carbon dioxide, water, nitrogen and oxygen. The catalyst is poisoned by the adsorption of Pb (lead). The automobiles with catalytic converter require unleaded petrol.

11.7.3 Inhibitors : Inhibitors are substances those decrease rate of chemical reaction.

Examples,

- Chloroform was once used as anaesthetic. It forms poisonous substance, carbonyl chloride by air oxidation.

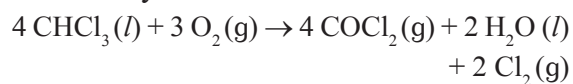

When 2% ethanol is added to chloroform, the formation of $COCl_2$ is suppressed. Ethanol acts as an inhibitor and retards the above reaction.

- Hydrogen peroxide decomposes as,



The reaction is inhibited by addition of dilute acid or glycerol those are inhibitor.

11.8 Adsorption Theory of Heterogeneous catalysis: The catalytic action occurs on the surface of a catalyst. The mechanism involves five steps.

- Diffusion of reactants toward the surface of the catalyst.
- Adsorption of reactant molecules on the surface of the catalyst.
- Occurrence of chemical reaction on the catalyst surface and formation of an intermediate.
- Formation of products.
- Desorption of reaction products from the catalyst surface. Products leave catalyst surface.

The steps involved can be shown as :

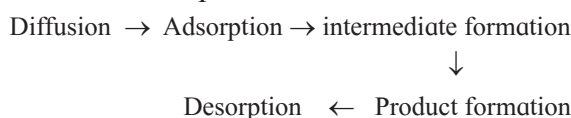

Fresh reactant molecules can replace the products to start the cycle again as in step (i). This explains why catalyst remains unchanged in mass and chemical composition at the end of the reaction.

11.8.1 Important features of solid catalysts:

a. Catalytic activity : The activity of a catalyst depends on the strength of chemisorption. If large number of reactant molecules (gas or liquid) are strongly adsorbed on the surface of solid catalyst, the catalyst is said to be active. However, the adsorption of reactant molecules on the surface, that is, the bond form between adsorbate and adsorbent surface should not be very strong so that they are not immobilized.

It has been found that d-block metals such as Fe, V and Cr tend to be strongly active toward O_2 , C_2H_2 , C_2H_4 , CO , H_2 , CO_2 , N_2 etc; Mn and Cu are unable to adsorb N_2 and CO_2 . The metals Mg and Li adsorb O_2 selectively.

b. Catalytic selectivity : Some solid catalysts are selective in their action. The same gaseous reactants produce different products when different catalysts are used.

For example,

i. The gaseous ethylene and O_2 react to produce different products with different catalysts.

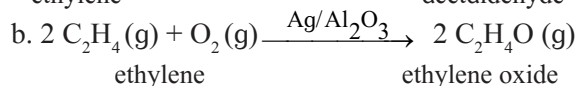
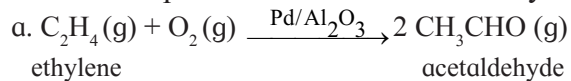

ii. The gaseous carbon monoxide and H_2 produce different products by using different catalysts.

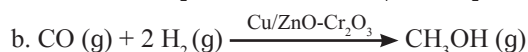
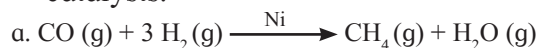

c. Shape selective catalysis by zeolites :

Zeolites are aluminosilicates with three-dimensional network of silicates. Some silicon atoms in this network are replaced by aluminium atoms giving Al-O-Si framework. This results in microporous structure. The reactions in zeolites are dependent on the size and shape of reactant or products and also on pores and cavities of zeolites. Zeolites, therefore, are shape selective catalysts.

In petroleum industry, zeolite catalyst ZSM-5 converts alcohols directly to gasoline (petrol) by dehydration which gives a mixture of hydrocarbons.

11.9 Colloids : A number of substances we use in our day to day life are colloids. For example, milk, butter, jelly, whipped cream, mayonnaise. Colloid chemistry is the chemistry of everyday life. Knowledge of colloid chemistry is essential for understanding about many useful materials like cement, bricks, pottery, porcelain, glass, enamels; oils, lacquers; rubber, celluloid and other plastics, leather, paper, textiles, filaments, crayons, inks, road construction material etc. In many daily processes like cooking, washing, dyeing, painting, ore floatation, water purification, sewage disposal, smoke prevention, photography, pharmacy, use of colloids is important.

Colloids are heterogeneous mixtures. The component of colloid present in the largest proportion is called **dispersion medium** and the other components are called **dispersed phase**. The particles of the dispersed phase are larger than the size of a molecule and smaller than particles which we can see with naked eye.

Observe the formation of solution of salt and water. Salt dissolves completely in water and forms homogeneous system. On the other hand ground coffee or tea leaves with milk form suspension. Between the two extremes of solution and suspension, we observe a large group of systems called colloidal dispersions or simply colloids.

The essential difference between a solution and a colloid is particle size. **Solutions** contain solute particles with diameter in the range 0.1 to 2 nm, the size of typical ion or small molecule. Solutions are **transparent** and may be coloured and do not separate on standing. On the other hand, **colloids** such as milk, fog contain particles of dispersed phase with diameters in the range at 2 to 500 nm. They are **translucent** to light and do not separate on standing.

11.9.1 : Examples of colloids : Some examples of phenomenon observed in our daily life, which are understood in terms of colloids are as follows :

i. Blue colour of the sky : The sky appears blue to us because minute dust particles along with minute water droplets dispersed in air scatter blue light which reaches our eyes.

ii. Blood : It is a colloidal dispersion of plasma proteins and antibodies in water. (At the same time blood is also a suspension of blood cells and platelets in water.)

iii. Soils : Fertile soils are colloidal in nature where humus acts as a protective colloid. Soil adsorbs moisture and nourishing materials due to its colloidal nature.

Table 11.4 :Types of colloids based on physical state

Dispersed phase	Dispersion medium	Type of colloid	Examples
solid	solid	solid sol	coloured glasses, gem stones, porcelain, paper
solid	liquid	sols and gels	paints, cell fluids, gelatin, muddy water, starch solution.
solid	gas	aerosol	smoke, dust
liquid	solid	gel	cheese, butter, jellies
liquid	liquid	emulsion	milk, hair cream
liquid	gas	aerosol	fog, mist, cloud, hair sprays, insecticide sprays.
gas	solid	solid sol	pumice stone, foam rubber, plaster
gas	liquid	foam	froth, whipped cream, soap lather

Table 11.5 : Distinction between Lyophilic and Lyophobic colloids

Lyophilic colloids	Lyophobic colloids
1. Formed easily by direct mixing.	Formed only by special methods.
2. Reversible.	Irreversible.
3. The particles are not easily visible even under ultramicroscope.	The particles are easily detected under ultramicroscope.
4. These are self stabilized.	These are unstable and hence require traces of stabilizers.
5. Addition of large amount of electrolytes causes precipitation/coagulation.	Addition of small amount of electrolytes causes precipitation/ coagulation.
6. Viscosity of dispersed phase much higher than that of the dispersion medium.	Viscosity of dispersed phase is nearly the same as the dispersion medium.
7. Surface tension of dispersed phase is lower than medium.	Surface tension of dispersed phase is nearly the same as the dispersion medium.

iv. Fog, mist and rain : Mist is caused by small droplets of water dispersed in air. Fog is formed whenever there is temperature difference between ground and air. A large portion of air containing dust particles gets cooled below its dew point, the moisture from the air condenses on the surface of these particles which form fine droplets, which are colloid particles and float in air as fog or mist.

11.9.2 Classification of colloids : Colloids are classified in three different ways.

a. Classification of colloids based on physical state : Table 11.4 illustrates the types of colloids in accordance with the physical states of dispersed phase and dispersion medium.

b. Classification of colloids based on interaction or affinity of phases : On the basis of interaction or affinity of phases, a colloidal solution is classified as lyophilic and lyophobic. If water is dispersion medium, the

terms hydrophilic and hydrophobic are used.

i. Lyophilic colloids: Lyo means liquid and philic means loving. A colloidal solution in which the particles of dispersed phase have a great affinity for the dispersion medium are lyophilic colloids. If the lyophilic sol is evaporated, the dispersed phase separates. But if it is remixed with the medium, the sol can be formed again. That is why such sols are called reversible sols. They are stable and difficult to coagulate.

ii. Lyophobic colloids: Colloidal solution in which the particles of the dispersed phase have no affinity for the dispersion medium are lyophobic colloids. Phobic means fearing, hence liquid hating. The common examples are Ag, Au, hydroxides like $\text{Al}(\text{OH})_3$, $\text{Fe}(\text{OH})_3$, metal sulfides. Once precipitated/coagulated they have little tendency or no tendency to revert back to colloidal state.

Table 11.5 shows comparison of liophilic and liophobic colloids.

c. Classification of colloids based on molecular size : Colloids are classified into three types in accordance with size of their molecules.

i. Multimolecular Colloids : The individual particles consist of an aggregate of atoms or small molecules with size less than 10^3 pm. For examples : **Gold sol** consists of particles of various sizes having several gold atoms. Colloidal solution in which particles are held together with van der Waals force of attraction is called multimolecular colloid. For Example, S_8 sulfur molecules.

ii. Macromolecular colloids : The molecules of the dispersed phase are sufficiently large in size (macro) to be of colloidal dimensions. Examples are starch, cellulose, proteins, polythene, nylon, plastics.

iii. Associated colloids or micelles : The substances behave as normal electrolytes at low concentration and associated in higher concentration forming a colloidal solution. The associated particles are called Micelles. For example, soap, detergent. Soap molecule

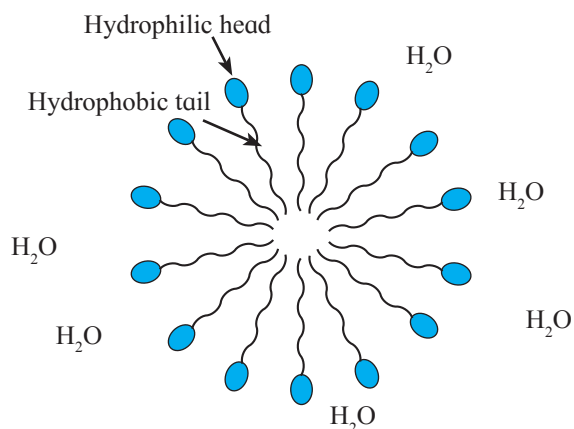

Fig. 11.5 : Soap micelle in water

has a long hydrophobic hydrocarbon chain, called **tail**, attached to hydrophilic ionic group carboxylate, called **head**. In water the soap molecules arrange themselves to form spherical particles that are called **micelles**. (Fig. 11.5) In each micelle the hydrophobic

tails of soap molecules point to the centre and the hydrophilic heads lie on the surface of the sphere. As a result of this, soap dispersion in water is stable.

11.9.3 Preparation of Colloids : A few important methods for the preparation of colloids are as follows :

a. Chemical methods : By double decomposition, oxidation, reduction or hydrolysis. Molecules of water insoluble products of these reaction aggregate together and form sols.

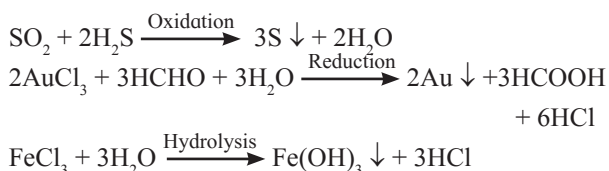

b. Electrical disintegration by Bredig's Arc method : This process involves vaporization as well as condensation. Colloidal sols of metals such as gold, silver, platinum can be prepared by this method.

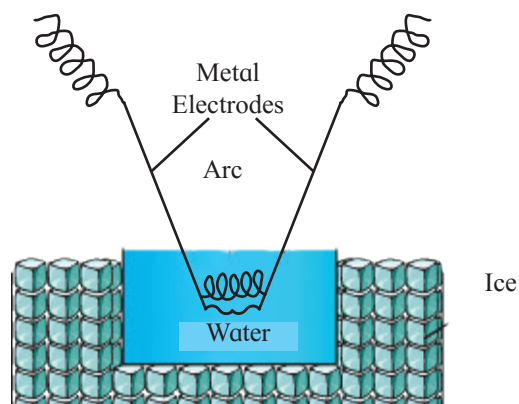

Fig. 11.6 : Bredig's arc method

In this method, electric arc is struck between electrodes of metal immersed in the dispersion medium. The intense heat produced vapourises the metal which then condenses to form particles of colloidal sol.

c. Peptization : During peptization a precipitate is converted into colloidal sol by shaking with dispersion medium in the presence of a small amount of an electrolyte. The electrolyte used, is known as peptizing agent.

During the process, the precipitate adsorbs one of the ions of the electrolyte on its surface, positive or negative charge is developed on the precipitate which finally breaks up into small particles of colloidal size.

11.9.4 Purification of colloidal solution :

Colloidal solution generally contains excessive amount of electrolytes and some other soluble impurities. A small quantity of an electrolyte is necessary for the stability of colloidal solution. A large quantity of electrolyte may result in coagulation. It is also necessary to reduce soluble impurities.

“The process used for reducing the amount of impurities to a requisite minimum is known as purification of colloidal solution.”

Purification of colloidal solution can be carried out using dialysis by the following method.

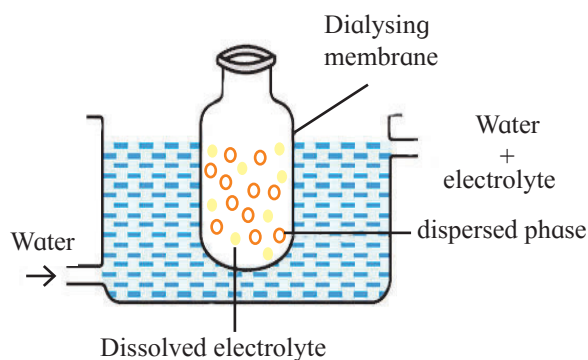

Fig 11.7 : Dialysis

Dialysis : “It is a process of removing a dissolved substance from a colloidal solution by diffusion through a suitable membrane.

The apparatus used is dialyser. A bag of suitable membrane containing the colloidal solution is suspended in a vessel through which fresh water is continuously flowing. The molecules and ions diffuse through membrane into the outer water and pure colloidal solution is left behind.

11.9.5 Properties of colloidal dispersions :

Various properties exhibited by colloidal dispersions are described below.

a. General properties.

- Colloidal system is heterogeneous and consists of two phases, dispersed phase and dispersion medium.
- The dispersed phase particles pass slowly through parchment paper or animal membrane, but readily pass through ordinary filter paper.
- The particles usually are not detectable by powerful microscope.

b. Optical property:

Tyndall effect: Tyndall observed that when light passes through true solution the path of light through it cannot be detected.

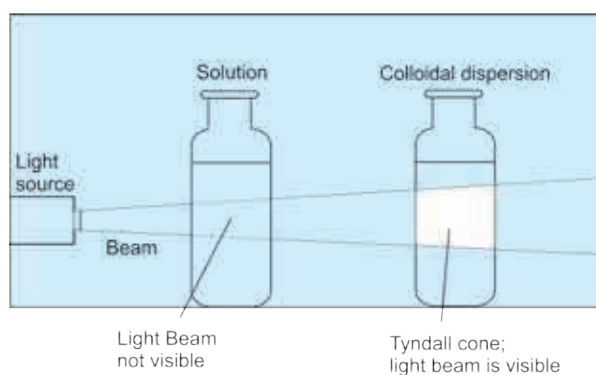

Fig. 11.8 :Tyndall effect

However, if the light passes through a colloidal dispersion, the particles scatter some light in all directions and the path of the light through colloidal dispersion becomes visible to observer standing at right angles to its path.

“The phenomenon of scattering of light by colloidal particles and making path of light visible through the dispersion is referred as Tyndall effect”.

“The bright cone of the light is called Tyndall cone”. Tyndall effect is observed only when the following conditions are satisfied.

- The diameter of the dispersed particles is not much smaller than the wavelength of light used.
- The refractive indices of dispersed phase and dispersion medium differ largely.

Importance of Tyndall effect:

- It is useful in determining number of particles in colloidal system and the particle size therein.

ii. It is used to distinguish between colloidal dispersion and true solution.

c. Colour :

i Colour of colloidal solution depends on the wavelength of light scattered by dispersed particles.

The colour of colloidal dispersion also changes with the manner in which the observer receives the light. For example: Mixture of a few drops of milk and large amount of water appears blue when viewed by the scattered light and red when viewed by transmitted light. (Refer to 7th std science book of Balbharati.)

ii. It also depends on size of colloidal particles For example, finest gold sol is red in colour whereas with increase in size it appears purple.

d. Kinetic Property : The colloidal or microscopic particles undergo ceaseless random zig-zag motion in all directions in a fluid. This motion of dispersed phase particles is called Brownian motion. British botanist, Robert Brown, observed such motion of pollen grains under a microscope. The random motion was explained by Albert Einstein in 1905.

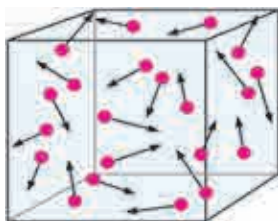

Fig. 11.9 : Brownian motion

Cause of Brownian motion :

i. Constant collision of particles of dispersed phase with the fast moving molecules of dispersion medium (fluid).

ii. Due to this, the dispersed phase particles acquire kinetic energy from the molecules of the dispersion medium. This kinetic energy brings forth Brownian motion.

e. Electrical Properties :

i. Charge on colloidal particles: Colloidal particles carry an electric charge. The nature of this charge is the same on all particles for a given colloidal solution which can be either

positive or negative. Some common sols with the nature of charge on the particles are listed in Table 11.6.

Table 11.6 : Charge on dispersed particles

Positively charged sols	Negatively charged sols
1. Hydrated metallic oxides $Al_2O_3 \cdot xH_2O$, $CrO_3 \cdot xH_2O$, $Fe_2O_3 \cdot xH_2O$.	Metals, Cu, Ag, Au Sols metallic sulphides As_2S_3 , Sb_2S_3 , Cds
2. Basic dye stuff, methylene blue sols	Acid dye stuff, eosin, congo red sol
3. Haemoglobin (blood)	Sols of starch, gum
4. Oxides : TiO_2 sol	Gelatin, clay, gum sols

ii. Electrophoresis : Electrophoresis set up is shown in Fig. 11.10.

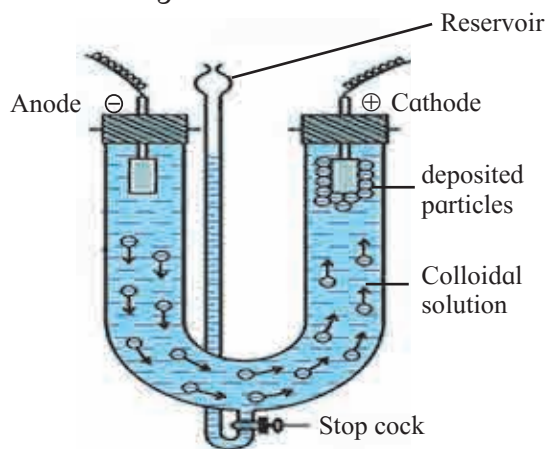

Fig. 11.10 : Electrophoresis

Figure shows U tube set up in which two platinum electrodes are dipped in a colloidal solution. When electric potential is applied across two electrodes, colloidal particles move towards one or other electrode.

“The movement of colloidal particles under an applied electric potential is called electrophoresis.”

Positively charged particles move towards cathode while negatively charged particles migrate to anode and get deposited on the respective electrode.

iii. Electroosmosis : Movement of dispersed particles can be prevented by suitable means, such as use of membrane. Then it is observed that the dispersion medium begins to move in an electric field. This is termed as electroosmosis.

Applications of electrophoresis:

- i. On the basis of direction of movement of the colloidal particles under the influence of electric field, it is possible to know the sign of charge on the particles.
- ii. It is also used to measure the rate of migration of sol particles.
- iii. Mixture of colloidal particles can be separated by electrophoresis since different colloidal particles in mixture migrate with different rates.

f. Coagulation: 'The precipitation of colloids by removal of charge associated with colloidal particles is called coagulation.'

The charge on the colloidal particles is due to the preferential adsorption of ions on their surface. For precipitation of lyophobic colloids removal of charge is required. A situation with lyophilic colloids is a little different. The lyophilic particles first attract the molecules of dispersion medium and form a layer of medium surrounding the particles, which may adsorb the ions. Hence for the precipitation of lyophilic colloids, removal of charge on layer of medium is necessary.

11.9.6 Methods to effect coagulation : A coagulation of the lyophobic sols can be carried out in the following ways.

- i. By electrophoresis : The colloidal particles move towards oppositely charged electrodes, get discharged and precipitate.
- ii. By mixing two oppositely charged sols : Oppositely charged sols when mixed in almost equal proportions neutralize their charges and get precipitated.

Example - Mixing of hydrated ferric oxide (positive sol) and arsenious sulfide (negative sol) brings them in the precipitated forms. This type of coagulation is called mutual coagulation.

iii. By boiling : When a sol is boiled, the adsorbed layer is disturbed as a result of increased collisions with molecules in dispersion medium. This reduces charge on the particles and subsequently settling down as a precipitate.

iv. By persistent dialysis: On prolonged dialysis, traces of the electrolyte present in the sol are removed almost completely. The colloids then become unstable and finally precipitate.

v. By addition of electrolytes : When excess of an electrolyte is added, the colloidal particles are precipitated.

Hardy-Schulze rule : Generally, the greater the valence of the flocculating ion added, the greater is its power to cause precipitation. This is known as Hardy - Schulze rule. In the coagulation of negative sol, the flocculating power follows the order: $Al^{3+} > Ba^{2+} > Na^{+}$

Similarly, coagulation of positive sol, reveal : $[Fe(CN)_6]^{4-} > PO_4^{3-} > SO_4^{2-} > Cl^{-}$

11.9.7 Emulsions : A colloidal system in which one liquid is dispersed in another immiscible liquid is called an emulsion. There are liquid-liquid colloidal system in which both liquids are completely or partially immiscible.

Types of emulsions :

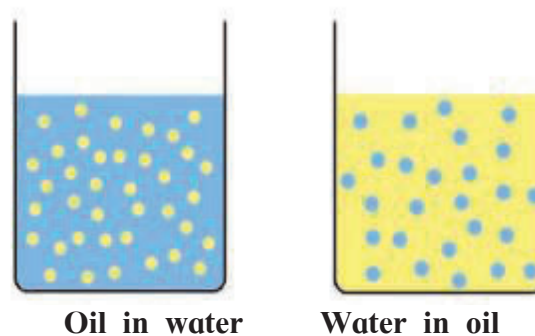

Fig. 11.11 : Emulsions

There are two types of emulsions (Fig. 11.15).

i. Emulsion of oil in water (o/w type) : An emulsion in which dispersed phase is oil and dispersion medium is water is called emulsion of oil in water. For example : milk, vanishing cream, paint etc. Milk consists of particles of fat dispersed in water.

ii. Emulsion of water in oil (w/o type): An emulsion in which dispersed phase is water and dispersion medium is oil is called emulsion of water in oil. For example, codliver oil consists of particles of water dispersed in oil. Some other examples of this type include butter, cream, etc.

Table 11.7 describes difference between the two types of emulsion.

Table 11.7 : Distinction between oil in water and water in oil emulsions

Oil in water	Water in oil
1. Oil is the dispersed phase and water is the dispersion medium.	Water is dispersed phase and oil is the dispersion medium.
2. If water is added, it will be miscible with the emulsion.	If oil is added, it will be miscible with the emulsion.
3. An addition of small amount of an electrolyte makes the emulsion conducting.	Addition of small amount of an electrolyte has no effect on conducting power.
4. Water is continuous phase.	Oil is continuous phase.
5. Basic metal sulfates, water soluble alkali metal soaps are used as emulsifiers.	Water insoluble soaps such as those of Zn, Al, Fe, alkaline earth metals are used as emulsifiers.

Properties of Emulsion :

1. Emulsion can be diluted with any amount of the dispersion medium. On the other hand, the dispersed liquid when mixed forms a separate layer.
2. The droplets in emulsions are often negatively charged and can be precipitated by electrolytes.
3. Emulsions show Brownian movement and Tyndall effect.
4. The two liquids in emulsions can be separated by heating, freezing or centrifuging etc.

11.9.8 Applications of colloids : Colloids find applications in industry and in daily life. Following are some examples.

i. Electrical precipitation of smoke : Smoke is colloidal solution of solid particles of carbon, arsenic compound, dust etc. in air. When smoke is allowed to pass through chamber containing plates having charged

smoke particles they lose their charge and get precipitated.

The particles settle down on the floor of the chamber. The precipitator is called Cottrell precipitator.

ii. Purification of drinking water: Water obtained from natural sources contains colloidal impurities. By addition of alum to such water, colloidal impurities get coagulated and settled down. This makes water potable.

iii. Medicines: Usually medicines are colloidal in nature. Colloidal medicines are more effective owing to large surface area to volume ratio of a colloidal particle, and easy assimilation.

Argyrol is a silver sol used as an eye lotion. Milk of magnesia, an emulsion is used in stomach disorders.

iv. Rubber Industry: - Rubber is obtained by coagulation of latex.

v. Cleansing action of soaps and detergents

vi. Photographic plates, films, and industrial products like paints, inks, synthetic plastics, rubber, graphite lubricants, cement etc. are colloids.



Internet my friend

1. Brownian motion
<https://myyoutube.com>watch>
2. Collect information about Surface Chemistry.
3. Collect information about Adsorption.
4. Collect information about Brownian Motion



Activity :

Calculate surface area to volume ratio of spherical particle. See how the ratio increases with the reduction of radius of the particle. Plot the ratio against the radius.



Exercises

1. Choose the correct option.

- A. The size of colloidal particles lies between-
- 10^{-10} m and 10^{-9} m
 - 10^{-9} m and 10^{-6} m
 - 10^{-6} m and 10^{-4} m
 - 10^{-5} m and 10^{-2} m
- B. Gum in water is an example of
- True solution
 - Suspension
 - Lyophilic sol
 - Lyophobic sol
- C. In Haber process of production of ammonia K_2O is used as
- catalyst
 - inhibitor
 - promotor
 - adsorbate
- D. Fruit Jam is an example of-
- sol
 - gel
 - emulsion
 - True solution

2. Answer in one sentence :

- A. Name type of adsorption in which vander Waals forces are present.
- B. Name type of adsorption in which compound is formed.
- C. Write an equation for Freundlich adsorption isotherm.

3. Answer the following questions:

- A. Define the terms:
- Inhibition
 - Electrophoresis
 - Catalysis.
- B. Define adsorption. Why students can read black board written by chalks?
- C. Write characteristics of adsorption.
- D. Distinguish between Lyophobic and Lyophilic sols.
- E. Identify dispersed phase and dispersion medium in the following colloidal dispersions.
- | | |
|-----------------|----------|
| a. milk | b. blood |
| c. printing ink | d. fog |
- F. Write Hardy-Sulze rules.
- G. Write notes on :
- Tyndall effect
 - Brownian motion
 - Types of emulsion
 - Hardy-Schulze rule

- H. Explain in brief : Electrophoresis diagrammatically. What are its applications ?
- I. Explain why finely divided substance is more effective as adsorbent?
- J. What is the adsorption Isotherm?
- K. Aqueous solution of raw sugar, when passed over beds of animal charcoal, becomes colourless. Explain.
- L. What happens when a beam of light is passed through a colloidal sol.
- M. Mention factors affecting adsorption of gas on solids.
- N. Give four uses of adsorption.
- O. Explain Bredig's arc method.
- P. Explain the term emulsions and types of emulsions.

4. Explain the following :

- A. Explain why finely divided substance is more effective as adsorbent ?
- B. Explain graphically Freundlich adsorption isotherm.

5. Distinguish between the following :

- A. Adsorption and absorption. Give one example.
- B. Physisorption and chemisorption. Give one example.

6. Adsorption is surface phenomenon. Explain.

7. Explain how the adsorption of gas on solid varies with

- Nature of adsorbate and adsorbent
- Surface area of adsorbent

8. Explain two applications of adsorption.

9. Explain micelle formation in soap solution.

10. Draw labelled diagrams :

- Tyndall effect
- Dialysis
- Bredig's arc method
- Soap micelle



Activity :

Collect the information about methods to study surface chemistry.

12. Chemical Equilibrium



Can you recall?

What are the types of the following changes? Natural waterfall, spreading of smoke from burning incense stick, diffusion of fragrance of flowers. Can the above changes take place in the opposite direction ?

12.1 Introduction : You have learnt earlier that changes can be physical or chemical and reversible or irreversible. All the changes listed above are **irreversible physical changes**. You have also learnt earlier that chemical changes can be represented by chemical reactions when the exact chemical composition of reactants and products is known. In this chapter we are going to look at **reversible chemical reactions**. On allowing the reaction for a very long time so that the concentrations of the reactants or products do not vary, the reaction is said to have attained equilibrium.

12.1.1 Reversible reaction



Try this

Dissolve 4 g cobalt chloride in 40 ml water. It forms a redish pink solution. Add 60 ml concentrated HCl to this. It will turn violet. Take 5 ml of this solution in a test tube and place it in a beaker containing ice water mixture. The colour of solution will become pink. Place the same test tube in a beaker containing water at 90°C. The colour of the solution turns blue.

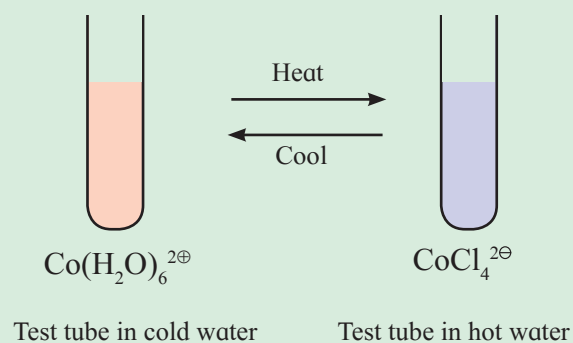

In the above activity, the change in colour of the solution is caused by the chemical reaction which reverses its direction with change of temperature.

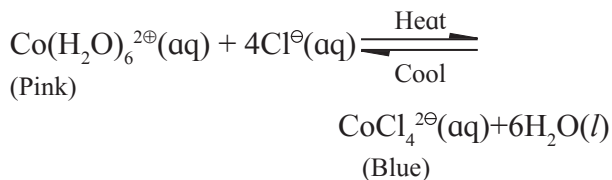

Can you tell?

What does violet colour of the solution in above indicate ?

The reaction in the above activity is an example of a **reversible reaction**. These are many chemical reactions which appear to proceed in a single direction. For example:

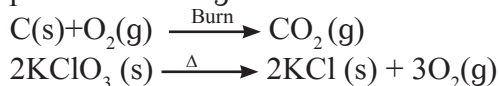

These are called **irreversible reactions**. They proceed only in single direction until one of the reactants is exhausted. Their direction is indicated by an arrow (\longrightarrow) pointing towards the products in the chemical equation. On the contrary, reversible reactions proceed in both directions. The direction from reactants to products is the **forward reaction**, whereas the opposite reaction from products to reactants is called the **reverse or backward reaction**. A reversible reaction is denoted by drawing in between the reactants and product a double arrow, one pointing in the forward direction and other in the reverse direction (\rightleftharpoons or \rightleftarrows).

For example :

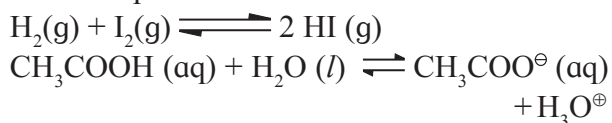

Consider an example of decomposition of calcium carbonate. Calcium carbonate when heated strongly, decomposes to form calcium oxide and carbon dioxide. If this reaction

is carried out in a closed container or open container, what do we observe ?



Do you know ?

What is a closed system ? In a closed system, there is no exchange of matter with the surroundings. In an open system, exchange of both matter and heat occurs with the surroundings.

If we perform the experiment at high temperature in a closed system, we find that after certain time, we have some calcium carbonate present. If we continue the experiment over a longer period of time at the same temperature, we find the concentrations of calcium carbonate, calcium oxide and carbon dioxide are unchanged. The reaction thus appears to have stopped and we say the system has attained the equilibrium. Actually, the reaction does not stop but proceeds in both the directions with equal rates. In other words calcium carbonate decomposes to give calcium oxide and carbon dioxide at a particular rate. Exactly at the same rate the calcium oxide and carbon dioxide recombine and form calcium carbonate.

Such reactions which do not go to completion and occur in both the directions simultaneously are **reversible reactions**. A reversible reaction may be represented in general terms as :

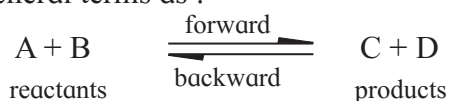

The double arrow indicates that the reaction is reversible.

Consider the reaction of decomposition of calcium carbonate occurring in an open system or container. Now what will happen ? We have seen that during decomposition of calcium carbonate, carbon dioxide can escape away. So, can we obtain back calcium carbonate ?
No !

Such a reaction is **irreversible reaction** which occurs only in one direction, namely, from reactants to products.

Reactions are chemically represented as follows

General representation :

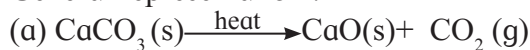

This represents the irreversible reaction in open container

In closed container : reversible reaction

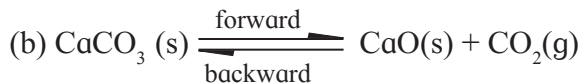

Do you know ?

Calcium oxide is also known as quicklime or lime. When heated strongly it glows bright white. This was used in theatre lighting, which gave rise to the phrase '*in the limelight*'.



Internet my friend

1. Equilibrium existing in the formation oxyhaemoglobin in human body.
2. Refrigeration system in equilibrium.

12.2 Equilibrium in physical processes

(a) Liquid - Vapour equilibrium

Let us now look at a reversible physical process of evaporation of liquid water into water vapour in a closed vessel (see Fig. 12.1).

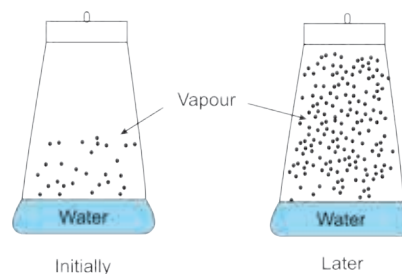

Fig. 12.1 : Water in a closed flask

Initially there is practically no vapour in the vessel. When a liquid evaporates in a closed container, the liquid molecules escape from the liquid surface into vapour phase building up vapour pressure. They also condense back into liquid state because the container is closed. In the beginning the rate of evaporation is high and the rate of condensation is low. But with time, as more and more vapour is formed, the rate of evaporation goes down and the rate

of condensation increases. Eventually the two rates become equal. This gives rise to a constant vapour pressure. This state is known as an ‘**equilibrium state**’. In this state, the number of molecules leaving the liquid surface equals the number those return to liquid from the vapour state. Across the interface, there is a lot of activity between the liquid and the vapour. This state, when the rate of evaporation is equal to the rate of condensation is called equilibrium state. It may be represented as :



At equilibrium, the pressure exerted by the gaseous water molecules at a given temperature remains constant, known as the equilibrium vapour pressure of water (or **saturated vapour pressure** of water or **aqueous tension**). The saturated vapour pressure increases with increase of temperature. In the case of water, the saturated vapour pressure is 1.013 bar (1atm) at 100 °C. Therefore, water boils at 100 °C when exposed to 1 atm pressure. For any pure liquid at 1 atm pressure the temperature at which its saturated vapour pressure equals to atmospheric pressure is called the normal boiling point of that liquid. The boiling point of water is 100° C at 1.013 bar pressure, whereas the boiling point of another liquid ethyl alcohol is 78 °C.

b. Solid - liquid equilibrium

Consider a mixture of ice and water in a perfectly insulated thermos flask at 273 K.

It is an example of solid-liquid equilibrium. Ice and water are at constant temperature. They remain in what is called solid-liquid equilibrium.

c. Solid - vapour equilibrium :



Try this

- Place some iodine crystals in a closed vessel. Observe the change in colour intensity in it. After some time the vessel gets filled up with violet coloured vapour.

The intensity of violet colour becomes stable after certain time.

What do you see in the flask (see Fig. 12.2)?



Fig. 12.2 Solid iodine in equilibrium with its vapour

We see both, that is, solid iodine and iodine vapour in the closed vessel. It means solid iodine sublimates to give iodine vapour and the iodine vapour condenses to form solid iodine. The stable intensity of the colour indicates a state of equilibrium between solid and vapour iodine. We can write the same as follows:

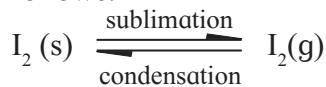

Other examples showing this kind of equilibrium are :

- Camphor (s) \rightleftharpoons Camphor (g)
- Ammonium chloride (s) \rightleftharpoons Ammonium chloride (g).



Try this

- Dissolve a given amount of sugar in minimum amount of water at room temperature
- Increase the temperature and dissolve more amount of sugar in the same amount of water to make a thick sugar syrup solution.
- Cool the syrup to the room temperature.

Note the observation : Sugar crystals separate out.

In a saturated solution there exists dynamic equilibrium between the solute molecules in the solid state and in dissolved state.



The rate of dissolution of sugar

= The rate of crystallization of sugar



Do you know ?

1. What is a saturated solution ?

A saturated solution is the solution when additional solute can not be dissolved in it at the given temperature. The concentration of solute in a saturated solution depends on temperature.

12.3 Equilibrium in chemical process :

If a reaction takes place in a closed system so that the products and reactants cannot escape, we often find that reaction does not give a 100 % yield of products. Instead some reactants remain after the concentrations stop changing. **When there is no further change in concentration of reactant and product, we say that the reaction has attained equilibrium, with the rates of forward and reverse reactions being equal.** Chemical equilibrium at a given temperature is characterized by constancy of measurable properties such as pressure, concentration, density etc. Chemical equilibrium can be approached from either side.



Observe and Discuss

I. Colourless N_2O_4 taken in a closed flask is converted to NO_2 (a reddish brown gas) (See Fig. 12.3)



Figure 12.3 : N_2O_4 conversion to NO_2

The colour becomes lighter indicating the presence of NO_2 in the mixture. The formation of N_2O_4 from NO_2 is reversible. In such reaction the reactants combine to form the products and the products combine to give basic reactants.

As soon as the forward reaction produces any N_2O_4 , the reverse reaction begins and N_2O_4 starts dissociating back to NO_2 . At equilibrium, the concentrations of N_2O_4 and NO_2 remain unchanged and do not vary with time, because the rate of formation of N_2O_4 is equal to the rate of formation of NO_2 as shown in Fig. 12.3.

II. Consider the following dissociation reaction
 $2HI(g) \rightleftharpoons H_2(g) + I_2(g)$



Discuss

Colourless gas

Violet coloured gas

The reaction is carried out in a closed vessel starting with hydrogen iodide and following observations are noted

1. At first, there is an increase in the intensity of violet colour.
2. After certain time the increase in the intensity of violet colour stops.
3. When contents in a closed vessel are analysed at this stage, it is observed that reaction mixture contains the hydrogen iodide, hydrogen and iodine with their concentrations being constant over time.

The rate of decomposition of HI becomes equal to the rate of combination of H_2 and I_2 . At equilibrium, no net change is observed and both reactions continue to occur.

Let us start with hydrogen and iodine vapour in a closed container at a certain temperature.

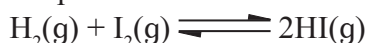

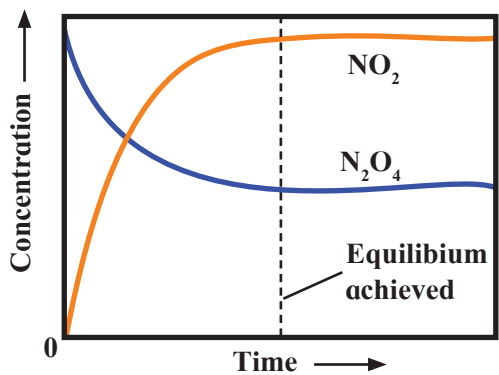

Fig. 12.4 (a) : Graph of forward and reverse reaction rates versus time for conversion of NO_2 to N_2O_4

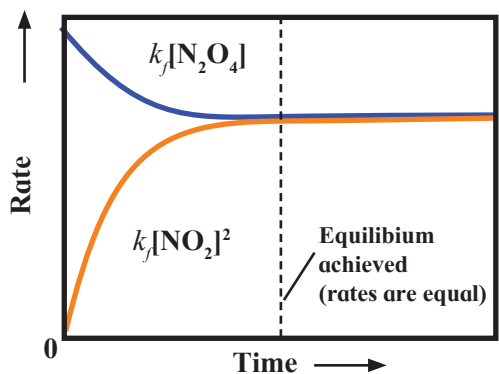

Fig. 12.4 (b) : Changes in reaction rates during a reversible reaction developing a chemical equilibrium. (Forward rate represented by upper curve in red and reverse reaction rate lower curve in blue)



Remember

For any reversible reaction in a closed system whenever the opposing reactions (forward and reaction) are occurring at different rates, the forward reaction will gradually become slower and the reverse reaction will become faster. Finally the rates become equal and equilibrium is established.

12.4 Law of mass action and equilibrium constant : The chemical equilibrium is mathematically described in terms of what is called the **equilibrium constant (K_c)**. We noted earlier that an equilibrium state is attained when the rate of the forward and reverse reactions become equal (refer Fig. 12.4).

12.4.1 Rate of chemical reaction : As any reaction proceeds the concentration of the reactants decreases and the concentration of the products increases. The rate of reaction thus can be determined by measuring the extent to which the concentration of a reactant decreases in the given time interval, or extent to which the concentration of a product increases in the given time interval. Mathematically, the rate of reaction is expressed as:

$$\text{Rate} = - \frac{d[\text{Reactant}]}{dT} = \frac{d[\text{Product}]}{dT}$$

Where d [reactant] and d [product] are the small decrease or increase in concentration during the small time interval dT .

12.4.2 Law of mass action : The law of mass action states that **the rate of a chemical reaction at each instant is proportional to the concentration product of all the reactants**. In case the balanced chemical equation shows more molecules of reactants, the concentration is raised to a power equal to the number of molecules of that reactant. A rate equation can be written for a reaction by applying the law of mass action as follows :



Here A and B are the reactants and C is the product. The concentrations of chemical species are expressed in mol L^{-1} and denoted by putting the formula in square brackets. By applying the law of mass action to this reaction we write a proportionality expression as :

$$\text{Rate} \propto [A][B]$$

This proportionality expression is transformed into an equation by introducing a proportionality constant, k , as follows:

$$\text{Rate} = k [A][B] \quad \dots(12.1)$$

The Eq. (12.1) is called the **rate equation** and the proportionality constant, k , is called the **rate constant** of the reaction.

Problem 12.1 : Write the rate equation for the following reaction:



Solution : the rate equation is written by applying the law of mass action.

i. The reactants are C and O_2

$$\text{Rate} \propto [C][O_2]$$

$$\therefore \text{Rate} = k [C][O_2]$$

ii. The reactant is $KClO_3$ and its 2 molecules appear in the balanced equation.

$$\therefore \text{Rate} \propto [KClO_3]^2$$

$$\therefore \text{Rate} = k [KClO_3]^2$$

12.4.3 Equilibrium constant : Consider a hypothetical reversible reaction $A+B \rightleftharpoons C+D$. As we have noted earlier, two reactions, namely forward and reverse reactions occur simultaneously in a reversible chemical reaction. We, therefore, write rate equations for the forward and reverse reactions :

$$\text{Rate}_{\text{forward}} \propto [A][B]$$

$$\therefore \text{Rate}_{\text{forward}} = k_f [A][B] \quad \text{..... (12.2)}$$

$$\text{Rate}_{\text{reverse}} \propto [C][D]$$

$$\therefore \text{Rate}_{\text{reverse}} = k_r [C][D] \quad \text{..... (12.3)}$$

At equilibrium, the rates of forward and reverse reactions are equal. Thus,

$$\text{Rate}_{\text{forward}} = \text{Rate}_{\text{reverse}}$$

$$\therefore k_f [A][B] = k_r [C][D]$$

$$\therefore \frac{k_f}{k_r} = K_C = \frac{[C][D]}{[A][B]} \quad \text{..... (12.4)}$$



Remember

At equilibrium the ratio of product multiplicative term denoting the concentration of products to that of the reactants is unchanged and equals K_C . The value of K_C depends upon the temperature. It is interesting to note that though the concentration ratio remains unchanged, both the forward as well as reverse reactions do proceed at equilibrium, but at the same rate. Therefore the chemical equilibrium is a **dynamic equilibrium**.

K_C is called the **equilibrium constant**.

The equilibrium constant depends on the form of the balanced chemical equation. Consider reversible reaction :



$$\text{The equilibrium constant } K_C = \frac{[C]^c [D]^d}{[A]^a [B]^b} \quad \text{..... (12.5)}$$

If the equilibrium is written as



$$K'_C = \frac{[A]^a [B]^b}{[C]^c [D]^d} = \frac{1}{K_C}$$

Thus equilibrium constant of the reverse chemical reaction is K'_C , is the reciprocal of the equilibrium constant K_C

Let us consider the equilibrium that occurs in the Haber process for synthesis of ammonia:

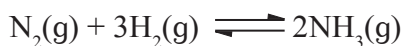

$$K_C = \frac{[NH_3]^2}{[N_2][H_2]^3} \quad \begin{array}{l} \longleftarrow \text{coefficient of } NH_3 \\ \longleftarrow \text{coefficient of } H_2 \end{array}$$

and for the equilibrium reaction written as



$$K'_C = \frac{[N_2][H_2]^3}{[NH_3]^2}$$

12.4.3 Equilibrium constant with respect to partial pressure (K_p) : For reactions involving gases, it is convenient to express the equilibrium constant in terms of partial pressure.

For the reaction,

\therefore For the reaction,



the equilibrium constant can be expressed using partial pressures (K_p) as given by

$$K_p = \frac{(P_C)^c (P_D)^d}{(P_A)^a (P_B)^b} \quad \text{..... (12.6)}$$

where P_A , P_B , P_C and P_D are equilibrium partial pressures of A, B, C and D, respectively.



Can you recall?

Ideal gas equation with significance of each term involved in it (refer Chapter 10, section 10.5.5).

$PV = nRT$, where P is pressure in pascal

n is number of moles of gas

V is volume in dm^3

R is molar gas constant in $\text{L atm K}^{-1} \text{mol}^{-1}$

T is absolute temperature

For a mixture of ideal gases, the partial pressure of each component is directly proportional to its concentration at constant temperature.

For component A,

$$P_A V = n_A RT \dots\dots (I)$$

$\frac{n_A}{V}$ is molar concentration of A in mol dm^{-3}

$$P_A = \frac{n_A}{V} \times RT, \quad \text{where } [A] = \frac{n_A}{V}$$

$$\therefore P_A = [A]RT \dots\dots (II)$$

Similarly for component B, $P_B = [B]RT \dots (III)$

For a chemical equilibrium reaction, both equilibrium constants are equal.

$$P_B = [B]RT$$

$$P_C = [C]RT$$

$$P_D = [D]RT$$

12.2.4 Relationship between K_p and K_c

Consider a general reversible reaction:

$$aA(g) + bB(g) \rightleftharpoons cC(g) + dD(g)$$

Now substituting equations for P_A, P_B, P_C, P_D in Eq. (12.2)

$$K_p = \frac{[P_C]^c [P_D]^d}{[P_A]^a [P_B]^b} = \frac{[C]^c (RT)^c [D]^d (RT)^d}{[A]^a (RT)^a [B]^b (RT)^b}$$

$$K_p = \frac{[C]^c [D]^d (RT)^{c+d}}{[A]^a [B]^b (RT)^{a+b}}$$

$$\therefore K_p = \frac{[C]^c [D]^d}{[A]^a [B]^b} \times (RT)^{(c+d)-(a+b)}$$

$$\therefore K_p = \frac{[C]^c [D]^d}{[A]^a [B]^b} \times (RT)^{\Delta n}$$

But $K_c = \frac{[C]^c [D]^d}{[A]^a [B]^b}$ from equation (12.5)

$$\therefore K_p = K_c (RT)^{\Delta n}, \quad \dots\dots (12.7)$$

where $\Delta n = (\text{number of moles of gaseous products}) - (\text{number of moles of gaseous reactants})$ in balanced chemical equation.

$$R = 0.08206 \text{ L atm K}^{-1} \text{mol}^{-1}$$

While calculating the value of K_p , pressure should be expressed in bar, because standard state of pressure is 1 bar. [1 pascal (Pa) = 1 Nm^{-2} and 1 bar = 10^5 Pa]

Problem 12.2 :

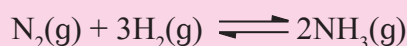

Write expressions for K_p and substitute expressions for P_{N_2} and P_{NH_3} .

$$\text{Solution : } K_p = \frac{(P_{NH_3})^2}{(P_{N_2})(P_{H_2})^3}$$

$$\therefore K_p = \frac{[NH_3(g)]^2 [RT]^2}{[N_2(g)]RT \cdot [H_2(g)]^3 [RT]^3}$$

$$\therefore K_p = \frac{[NH_3(g)]^2}{[N_2(g)][H_2(g)]^3} \times \frac{[RT]^2}{[RT][RT]^3}$$

$$\therefore K_p = K_c \times RT^{(2-4)}$$

$$\therefore K_p = K_c \times RT^{-2}$$

Problem 12.3 : For a chemical equilibrium reaction

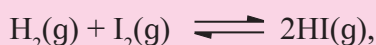

write an expression for K_p .

$$\text{Solution : } K_p = \frac{(P_{HI})^2}{(P_{H_2})(P_{I_2})}$$

$$\therefore K_p = \frac{[HI(g)]^2 [RT]^2}{[H_2(g)]RT \cdot [I_2(g)]RT}$$

$$\therefore K_p = \frac{[HI(g)]^2}{[H_2(g)][I_2(g)]} \times \frac{[RT]^2}{[RT][RT]}$$

$$\therefore K_p = K_c \times RT^{2-(1+1)}$$

$$\therefore K_p = K_c$$

12.5 Homogeneous and Heterogeneous equilibria

12.5.1 Homogeneous reactions and Heterogeneous reactions :

In a homogeneous equilibrium state all the reactants are in the same phase. An example of homogeneous gas phase equilibrium is dissociation of HI.



While Heterogeneous equilibrium results from a reversible reaction involving reactants and products those are in different phases.

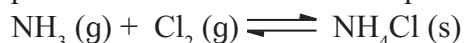

Just think

Two processes which are taking place in opposite directions in equilibrium.

How to write equilibrium constant expression for heterogeneous equilibrium?

12.3.2 Equilibrium constant for heterogeneous equilibria :

As stated earlier, equilibrium in a system having more than one phase is called heterogeneous equilibrium. Consider,



If ethanol is placed in a conical flask, liquid vapour equilibrium is established.



For a given temperature

$$K_c = \frac{[\text{C}_2\text{H}_5\text{OH}(\text{g})]}{[\text{C}_2\text{H}_5\text{OH}(\text{l})]}$$

But $[\text{C}_2\text{H}_5\text{OH}(\text{l})] = 1$

$$\therefore K_c = [\text{C}_2\text{H}_5\text{OH}(\text{g})]$$

Thus, at any given temperature density is constant irrespective of the amount of liquid, and the term in the denominator is also constant.

Similarly $\text{I}_2(\text{s}) \rightleftharpoons \text{I}_2(\text{g})$



Can you recall?

For any pure liquid and solid, the concentration is simply its density and this will not change no matter how much solid or liquid you use.

In an experiment of sublimation of iodine

$$K_c = [\text{I}_2(\text{g})]$$

Solids are pure substances with unchanging concentrations and thus equilibria including solids are simplified.



Remember

When writing an equilibrium constant expression use only the concentrations of gases (g) and dissolved substances (aq).

12.3.3 Units of equilibrium constant

The unit of equilibrium constant depends upon the expression of K_c which is different for different equilibria. Therefore, the unit of K_c is also different.

To calculate units of equilibrium constant

Equilibrium Reaction (I)	Equilibrium Reaction (II)
$\text{H}_2(\text{g}) + \text{I}_2(\text{g}) \rightleftharpoons 2\text{HI}(\text{g})$	$\text{N}_2(\text{g}) + 3\text{H}_2(\text{g}) \rightleftharpoons 2\text{NH}_3(\text{g})$
$K_c = \frac{[\text{HI}(\text{g})]^2}{[\text{H}_2(\text{g})][\text{I}_2(\text{g})]} \quad \dots (I)$	$K_c = \frac{[\text{NH}_3(\text{g})]^2}{[\text{N}_2(\text{g})][\text{H}_2(\text{g})]^3} \quad \dots (II)$
$\text{Units of } K_c = \frac{[\text{mol dm}^{-3}]^2}{[\text{mol dm}^{-3}][\text{mol dm}^{-3}]}$ $= \frac{[\text{mol dm}^{-3}]^2}{[\text{mol dm}^{-3}]^2}$	$\text{Units of } K_c = \frac{[\text{mol dm}^{-3}]^2}{[\text{mol dm}^{-3}][\text{mol dm}^{-3}]^3}$ $= \frac{[\text{mol dm}^{-3}]^2}{[\text{mol dm}^{-3}]^4}$ $= [\text{mol dm}^{-3}]^{-2}$ $= \text{mol}^{-2} \text{dm}^6$
<p>As all the units cancel out For (I), K_c has no units</p>	

Hint : Simplest way to calculate units of K_c is difference between number of moles in the numerator and number of moles at the denominator in equilibrium constant expression.

With reference to expression (II) to above, difference between number of moles =

$$\Delta n = 2 - (1+3)$$

$$\therefore \Delta n = 2 - 4$$

$$\therefore \Delta n = -2$$

\therefore units of $K_c = (\text{mol dm}^{-3})^{\Delta n}$

\therefore units of $K_c = (\text{mol dm}^{-3})^{-2}$

\therefore units of $K_c = \text{mol}^{-2}\text{dm}^6$

Similarly with reference to expression (I) \

units of $K_c = (\text{mol dm}^{-3})^{\Delta n} = (\text{mol dm}^{-3})^0$

$\therefore K_c$ has no unit.

Problem 12.4 : Write the equilibrium constant expression for the decomposition of baking soda. Deduce the unit of K_c from the above expression.

Solution :

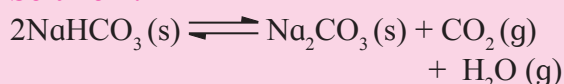

$$K_c = \frac{[\text{Na}_2\text{CO}_3(\text{s})][\text{CO}_2(\text{g})][\text{H}_2\text{O}(\text{g})]}{[\text{NaHCO}_3(\text{s})]^2}$$

$\therefore K_c = [\text{CO}_2(\text{g})][\text{H}_2\text{O}(\text{g})]$

$\therefore K_c$ has no unit.

12.6 Characteristics of equilibrium constant

1. The value of equilibrium constant is independent of initial concentrations of either the reactants or products.
2. Equilibrium constant is temperature dependent. Hence K_c , K_p change with change in temperature.
3. Equilibrium constant has a characteristic value for a particular reversible reaction represented by a balanced equation at a given temperature.
4. Higher value of K_c or K_p means more concentration of products is formed and the equilibrium point is more towards right hand side and vice versa.

12.7 Application of equilibrium constant

Some applications of equilibrium constant are discussed below.

12.7.1 Prediction of the direction of the reaction : For the reaction, $a\text{A} + b\text{B} \rightleftharpoons c\text{C} + d\text{D}$, the equilibrium constant is

$$K_c = \frac{[\text{C}]^c[\text{D}]^d}{[\text{A}]^a[\text{B}]^b},$$

where all concentrations are equilibrium concentrations.

The ratio is called reaction quotient, Q_c , when the concentrations are not necessarily equilibrium concentrations.

$$Q_c = \frac{[\text{C}]^c[\text{D}]^d}{[\text{A}]^a[\text{B}]^b},$$

The reaction quotient has same form as that of equilibrium constant, but involves concentrations that are not necessarily equilibrium concentrations. This concept is very useful and we compare Q_c with K_c for a reaction under given conditions. We can decide whether the forward or the reverse reaction should occur to establish the equilibrium. It is shown diagrammatically in Fig. 12.4.

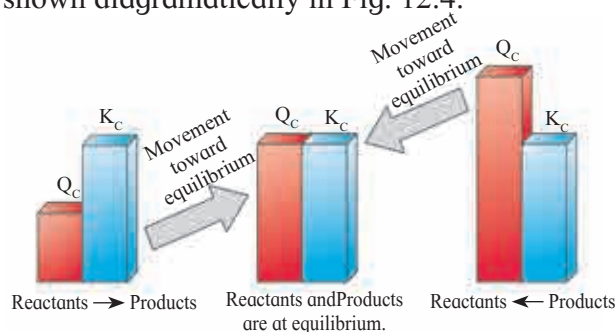

Fig. 12.4 : Predicting direction of reaction

If $Q_c < K_c$, the reaction will proceed from left to right, in forward direction, generating more product to attain the equilibrium.

If $Q_c = K_c$ the reaction is at equilibrium and hence no net reaction occurs.

If $Q_c > K_c$, the reaction will proceed from right to left, requiring more reactants to attain equilibrium.

A comparison of Q_c with K_c indicates the direction in which net reaction proceeds as the system tends to attain the equilibrium.

Note : The prediction of the direction of the reaction on the basis of Q_c and K_c values makes no comment on the time required for attaining the equilibrium.

12.7.2 : To know the extent of reaction :

Let us recall an expression for equilibrium constant K_c . (See Fig. 12.5). It indicates that the magnitude of K_c is

i. directly proportional to concentrations of the product.

ii. inversely proportional to the concentrations of the reactants.

The larger the value of the equilibrium constant K_C , the farther the reaction proceeds to the right before reaching the equilibrium state :

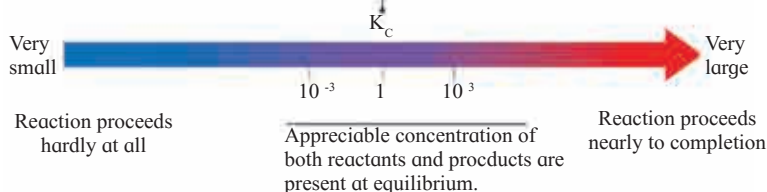

Fig 12.5 : Extent of reaction

Consider, for example, following two equilibrium reactions :

$2\text{H}_2(\text{g}) + \text{O}_2(\text{g}) \rightleftharpoons 2\text{H}_2\text{O}(\text{g})$	$2\text{H}_2\text{O}(\text{g}) \rightleftharpoons 2\text{H}_2(\text{g}) + \text{O}_2(\text{g})$
Equilibrium constant values $K_C = \frac{[\text{H}_2\text{O}(\text{g})]^2}{[\text{H}_2(\text{g})]^2[\text{O}_2(\text{g})]}$ $K_C = 2.4 \times 10^{47} \text{ At } 500 \text{ K}$	$K'_C = \frac{[\text{H}_2(\text{g})]^2[\text{O}_2(\text{g})]}{[\text{H}_2\text{O}(\text{g})]^2}$ $K'_C = \frac{1}{K_C} = \frac{1}{2.4 \times 10^{47}}$ $K'_C = 4.1 \times 10^{-48} = 0.41 \times 10^{-47} \text{ at } 500 \text{ K}$
1. Value of K_C is very high ($K_C > 10^3$).	1. Value of K_C is very low ($K_C < 10^{-3}$).
2. At equilibrium there is a high proportion of products compared to reactants.	2. At equilibrium, only a small fraction of the reactants are converted into products.
3. Forward reaction is favoured.	3. Reverse reaction is favoured.
4. Reaction is in favour of products and nearly goes to completion.	4. Reaction hardly proceeds towards the products.
$K_C \gg 1$. Reaction proceeds almost totally towards products.	$K_C \ll 1$. Reaction hardly proceeds towards the products.



Can you tell?

Comment on the extent to which the forward reaction will proceed, from the magnitude of the equilibrium constant for the following reactions :

- $\text{H}_2(\text{g}) + \text{I}_2(\text{g}) \rightleftharpoons 2\text{HI}(\text{g})$, $K_C = 20$ at 550 K
- $\text{H}_2(\text{g}) + \text{Cl}_2(\text{g}) \rightleftharpoons 2\text{HCl}(\text{g})$, $K_C = 10^{18}$ at 550 K

12.7.3 To calculate equilibrium concentrations : An equilibrium constant can be used to calculate the composition of an equilibrium mixture.

Consider an equilibrium reaction,
 $\text{CH}_3\text{COOH}(\text{aq}) + \text{C}_2\text{H}_5\text{OH}(\text{aq}) \rightleftharpoons \text{CH}_3\text{COOC}_2\text{H}_5(\text{aq}) + \text{H}_2\text{O}(\text{aq})$
 The equilibrium constant is 4.0 at a certain temperature.



Use your brain power

The value of K_C for the dissociation reaction $\text{H}_2(\text{g}) \rightleftharpoons 2\text{H}(\text{g})$ is 1.2×10^{-42} at 500 K. Does the equilibrium mixture contain mainly hydrogen molecules or hydrogen atoms ?

If we start with 2.0 mol of ethanoic acid and 2.0 mol of ethanol in 'V' litres. Let us find out the composition of equilibrium mixture. Consider x mol of ethyl ethanoate at equilibrium.



Internet my friend

Collect information about Chemical Equilibrium.

$\text{CH}_3\text{COOH} + \text{C}_2\text{H}_5\text{OH} \rightleftharpoons \text{CH}_3\text{COOC}_2\text{H}_5 + \text{H}_2\text{O}$				
Initial (No. of moles)	2.0	2.0	0	0
At equilibrium (No. of moles)	$(2.0 - x)$	$(2.0 - x)$	x	x
Equilibrium concentrations	$\frac{(2.0 - x)}{V}$	$\frac{(2.0 - x)}{V}$	$\frac{x}{V}$	$\frac{x}{V}$

Equilibrium constant

$$K_c = \frac{[\text{CH}_3\text{COOC}_2\text{H}_5][\text{H}_2\text{O}]}{[\text{CH}_3\text{COOH}][\text{C}_2\text{H}_5\text{OH}]}$$

$$\therefore 4.0 = \frac{\frac{x}{V} \times \frac{x}{V}}{\frac{(2.0 - x)}{V} \times \frac{(2.0 - x)}{V}}$$

substituting the value of equilibrium concentration

$$\therefore 4.0 = \frac{x^2}{(2.0 - x)^2}$$

$$\therefore \sqrt{4} = \frac{x}{2.0 - x}$$

$$\therefore 2 = \frac{x}{2.0 - x}$$

$$\therefore 4 - 2x = x$$

$$\therefore x = \frac{4}{3}$$

$$\therefore x = 1.33$$

$$\therefore (2.0 - x) = 0.67$$

Therefore, equilibrium concentrations are 0.67 mol of ethanoic acid, 0.67 mol of ethanol and 1.33 mol of ethyl ethanoate.

Problem 12.5 : Equal concentrations of hydrogen and iodine are mixed together in a closed container at 700 K and allowed to come to equilibrium. If the concentration of HI at equilibrium is 0.85 mol dm^{-3} , what are the equilibrium concentrations of H_2 and I_2 if $K_c = 54$ at this temperature ?

Solution : Balanced chemical reaction :

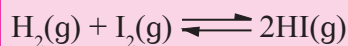

$$\therefore K_c = \frac{[\text{HI}(\text{g})]^2}{[\text{H}_2(\text{g})][\text{I}_2(\text{g})]}$$

on substituting the values

$$\therefore 54 = \frac{(0.85)^2}{[\text{H}_2(\text{g})]^2}$$

as initial concentrations of $\text{H}_2(\text{g})$ and $\text{I}_2(\text{g})$ are equal.

(Refer to the balanced chemical equation : 1 mole of H_2 reacts with 1 mole of I_2)
Equilibrium concentration of $\text{I}_2(\text{g}) =$
Equilibrium concentration of $\text{H}_2(\text{g})$

$$\therefore 54 = \frac{(0.85)^2}{[\text{H}_2(\text{g})]^2}$$

$$\therefore [\text{H}_2(\text{g})] = 0.12 \text{ mol dm}^{-3}$$

Equilibrium concentrations of H_2 and I_2 are equal to 0.12 mol dm^{-3} .

12.7.4 Link between chemical equilibrium and chemical kinetics :

We have deduced in section 12.4.3

$$K_c = \frac{k_f}{k_r} \quad \dots\dots (12.7)$$

Where k_f and k_r are velocity or **rate constants** of the forward and reverse reactions respectively.

This equation can be used to determine the composition of the reaction mixture

$k_f > k_r$	$k_f \approx k_r$
$\therefore K_c$ is very large.	k_f and k_r have comparable values $\therefore K_c$ is nearly one.
\therefore Reaction goes almost to completion.	Reaction never goes to completion.
\therefore If k_f is much larger than K_c , the reaction may be irreversible (Reverse reaction is too slow to be detected).	Comparable concentrations of reactants and products are present at equilibrium.



Remember

The equilibrium refers to the relative amounts of reactants and products and thus a shift in equilibrium in a particular direction will imply the reaction in that direction will be favoured.

Problem 12.6 : The equilibrium constant K_c for the reaction of hydrogen with iodine is 54.0 at 700 K.

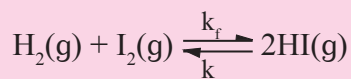

$K_c = 54.0$ at 700 K

a. If k_f is the rate constant for the formation of HI and k_r is the rate constant for the decomposition of HI, deduce whether k_f is larger or smaller than k_r .

Solution : As $K_c = \frac{k_f}{k_r} = 54.0$,

k_f is greater than k_r by a factor of 54.0

b. If the value of k_r at 700 K is 1.16×10^{-3} , what is the k_f ?

$$K_p = K_c \times k_r = 54.0 \times (1.16 \times 10^{-3}) \\ = 62.64 \times 10^{-3}$$

12.8 Le Chaterlier's principle and factors altering the composition of equilibrium :

We have learnt that a reaction attains a state of equilibrium under a certain set of conditions (of temperature, pressure, concentration and catalyst).

In general, if we add more reactant, the system will react to remove it. If we remove a product, the system will react to replenish it. Under these changed condition, new equilibrium will be established with different composition from the earlier equilibrium mixture.

The principal goal of chemical synthesis is to achieve maximum conversion of reactants to products with minimum expenditure of energy. To achieve this goal, the reaction conditions must be adjusted.

The qualitative effect of various factors on the composition of equilibrium mixture are described through the Le Chatelier's principle.

If a stress is applied to a reaction mixture at equilibrium, reaction occurs in the direction which relieves the stress. Stress means any change in concentration, pressure, volume or temperature which disturbs the original equilibrium. The direction that the reaction takes is the one that reduces the stress. For example, if you increase concentration of the reactants, reaction goes in a direction that tends to decrease concentration.

Le Chatelier's Principle :

It states that, when a system at equilibrium is subjected to a change in any of the factors determining the equilibrium conditions of a system, system will respond in such a way as to minimize the effect of change.

12.8.1 Influencing factors of Le Chatelier's Principle :

a. Change of concentration

Consider reversible reaction representing production of ammonia (NH_3)



The reaction proceeds with decrease in number of moles ($\Delta n = -2$) and the forward reaction is exothermic. Iron (containing a small quantity of molybdenum) is the catalyst.

$$\text{At equilibrium } Q_c = K_c = \frac{[\text{NH}_3]^2}{[\text{N}_2][\text{H}_2]^3} \dots\dots (I)$$

Stage I : system at equilibrium

Stage II : If equilibrium disturbed by making $Q_c < K_c$ by adding H_2 .

Due to addition of extra hydrogen, system is no longer at equilibrium.

How does a system regain its equilibrium ?

Stage III : Added hydrogen is to be used up and converted to more NH_3 .

System responds to any change in the concentration of the equilibrium mixture in order to restore the equilibrium.

Stage IV : System responds to restore equilibrium position.

According to Le-Chatelier's principle, the effect of addition of H_2 (or N_2 or both) is reduced by shifting the equilibrium from left to right so that the added N_2 or H_2 is consumed.

The forward reaction occurs to a large extent than the reverse reaction until the new equilibrium is established. This results in increased yield of NH_3 .



Remember

In general, if the concentration of one of the species in equilibrium mixture is increased, the position of equilibrium shifts in the opposite so as to reduce the concentration of this species. However, the equilibrium constant remains unchanged.

b. Effect of Pressure

You know that : Ideal gas equation is

$$PV = nRT,$$

solving P at constant temperature gives,

$$P = RT \frac{n}{V}$$

$\therefore P \propto \frac{n}{V}$, where the ratio $\frac{n}{V}$ is an expression for the concentration of the gas in mol dm^{-3}

1. An equilibrium mixture of dinitrogen tetroxide (colourless gas) and nitrogen dioxide (brown gas) set up in a sealed flask at a particular temperature (refer Fig. 12.3). The effect of change of pressure on the gaseous equilibrium can be followed by observing the change in its colour intensity. See Table 12.1.

Table 12.1 : Change in colour intensity

Change in pressure	Change in colour intensity	Shift in equilibrium position
1. Decrease in pressure	The colour darkens	To the right, the side with more molecules
2. Increase in pressure	The colour lightens to almost colourless	To the left, the side with fewer molecules

You earlier noted that for equilibrium reaction



Forward reaction takes place with increase of number of molecules, whereas reverse reaction takes place with decrease in number of molecules.

2. Consider the reaction,

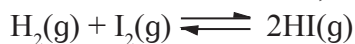

As there is the same number of molecules of gas on both sides, change of pressure has no effect on the equilibrium



Remember

1. There is no change in value of K_c during any change in pressure of the equilibrium reaction mixture.
2. A reaction in which decrease in volume takes place, reaction will be favoured by increasing pressure and increase in volume will be favoured with lowering pressure, temperature being constant.



Remember

In a reversible reaction, the reverse reaction has an energy change that is equal and opposite to that of the forward reaction.

c. Effect of Temperature :

Consider the equilibrium reaction,

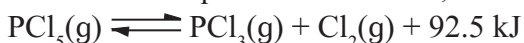

The forward reaction is exothermic. The reverse reaction is endothermic. An endothermic reaction consumes heat. Therefore, the equilibrium must shift in the reverse direction to use up the added heat (heat energy converted to chemical energy).

Now let us study the effect of change of temperature on the equilibrium constant.

1. Consider the equilibrium reaction :



$$\Delta H = -90 \text{ kJmol}^{-1}$$

Equilibrium constant K_c for the reaction, is given in Table 12.2.

$$K_c = \frac{[\text{CH}_3\text{OH}(\text{g})]}{[\text{CO}(\text{g})][\text{H}_2(\text{g})]^2}$$

Table 12.2

Temperature (K)	K_c
298	1.7×10^{17}
500	1.1×10^{11}
1000	2.1×10^6

The forward reaction is exothermic. According to Le Chatelier's principle an increase in temperature shifts the position of equilibrium to the left. Therefore, the concentration of $[\text{CH}_3\text{OH}(\text{g})]$ decreases and the concentration of $\text{CO}(\text{g})$ and $\text{H}_2(\text{g})$ increases.

$$K_c = \frac{[\text{CH}_3\text{OH}(\text{g})]}{[\text{CO}(\text{g})][\text{H}_2(\text{g})]^2}$$

Therefore, the value of K_c decreases as the temperature is increased.

d. Effect of Catalyst :

Rate of a chemical reaction, increases with the use of catalyst.

Consider an Esterification reaction :

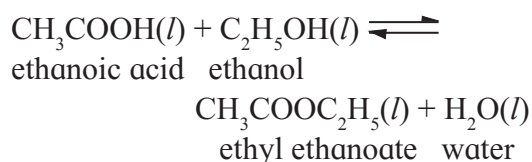

If the above reaction is carried out without catalyst, it would take many days to reach equilibrium. However, the addition of hydrogen ions (H^+) as catalyst reduces the time only to a few hours.



Remember

In all the cases of change in concentration, pressure, temperature and presence of catalyst, once the equilibrium has been re-established after the change, the value of K_c will be unaltered

A catalyst does not affect equilibrium constant and equilibrium composition of a reaction mixture.



Do you know ?

Catalyst lowers activation energy for the forward and reverse reactions by exactly the same amount.

A catalyst does not appear in the balanced chemical equation and in the equilibrium constant expression.

Let us **summarize** effects of all four factors on the position of equilibrium and value of K_c .

Effect of	Position of equilibrium	Value of K_c
Concentration	Changes	No change
Pressure	Changes if reaction involves change in number of gas molecules	No change
Temperature	Change	Change
Catalyst	No change	No change

Making ammonia The Haber process

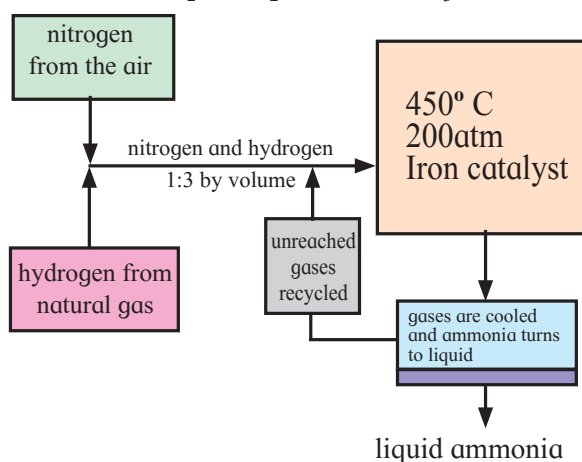

Fig. 12.6 The Haber process

12.9 Industrial Application :

The Haber process : (Industrial preparation of ammonia)

Industrial processes can be made efficient and profitable by applying ideas of rate of reaction and equilibrium.

The Haber process is the process of synthesis of ammonia gas by reacting together hydrogen gas and nitrogen gas in a particular stoichiometric ratio by volumes and at selected optimum temperature.



The reaction proceeds with a decrease in number of moles ($\Delta n = -2$) and the forward reaction is exothermic. Iron (containing a small quantity of molybdenum) is used as catalyst.

We studied earlier in section 12.8.1 a. how the change in concentration of the reactants affects the yield of ammonia. Now let us consider the effect of temperature and pressure on the synthesis of ammonia.

a. Effect of temperature : The formation of ammonia is exothermic reaction. Hence, lowering of temperature will shift the equilibrium to right. At low temperature however, the rate of reaction is small and longer time would be required to attain the equilibrium. At high temperatures, the reaction occurs rapidly with appreciable decomposition of ammonia. Hence, the optimum temperature has to be used. The **optimum temperature** is about 773 K.

b. Effect of pressure : The forward reaction is favoured with high pressure as it proceeds with **decrease in number of moles**. At high pressure, the catalyst becomes inefficient. Therefore optimum pressure need to be used. The **optimum pressure is about 250 atm**.



Can you tell?

1. If NH_3 is added to the equilibrium system, in which direction will the equilibrium shift to consume added NH_3 to reduce the effect of stress?
2. In this process, out of the reactions (reverse and forward reaction), which reaction will occur to a greater extent?
3. What will be the effect on yield of NH_3 ?



Internet my friend

1. Collect information about Haber Process in Chemical Equilibrium.
2. Youtube.Freesciencelessons The Haber Process.



Exercises

1. Choose the correct option

- A. The equilibrium, $\text{H}_2\text{O}(l) \rightleftharpoons \text{H}^+(\text{aq}) + \text{OH}(\text{aq})$ is
 a. dynamic b. static
 c. physical d. mechanical
- B. For the equilibrium, $\text{A} \rightleftharpoons 2\text{B} + \text{Heat}$, the number of 'A' molecules increases if
 a. volume is increased
 b. temperature is increased
 c. catalyst is added
 d. concentration of B is decreased
- C. For the equilibrium $\text{Cl}_2(\text{g}) + 2\text{NO}(\text{g}) \rightleftharpoons 2\text{NOCl}(\text{g})$ the concentration of NOCl will increase if the equilibrium is disturbed by
 a. adding Cl_2 b. removing NO
 c. adding NOCl d. removal of Cl_2
- D. The relation between K_c and K_p for the reaction $\text{A}(\text{g}) + \text{B}(\text{g}) \rightleftharpoons 2\text{C}(\text{g}) + \text{D}(\text{g})$ is
 a. $K_c = Yk_p$ b. $K_p = K_c^2$
 c. $K_c = \frac{1}{\sqrt{K_p}}$ d. $K_p/K_c = 1$
- E. When volume of the equilibrium reaction $\text{C}(\text{g}) + \text{H}_2\text{O}(\text{g}) \rightleftharpoons \text{CO}(\text{g}) + \text{H}_2(\text{g})$ is increased at constant temperature the equilibrium will
 a. shift from left to right
 b. shift from right to left
 c. be unaltered
 d. can not be predicted

2. Answer the following

- A. Write statement for Law of Mass action.
 B. Write an expression for equilibrium constant with respect to concentration.
 C. Derive mathematically value of K_p for for $\text{A}(\text{g}) + \text{B}(\text{g}) \rightleftharpoons \text{C}(\text{g}) + \text{D}(\text{g})$
 D. Write expressions of K_c for following chemical reactions
 i. $2\text{SO}_2(\text{g}) + \text{O}_2(\text{g}) \rightleftharpoons 2\text{SO}_3(\text{g})$
 ii. $\text{N}_2\text{O}_4(\text{g}) \rightleftharpoons 2\text{NO}_2(\text{g})$
 E. Mention various applications of equilibrium constant.

- F. How does the change of pressure affect the value of equilibrium constant ?
 J. Differentiate irreversible and reversible reaction.
 K. Write suitable conditions of concentration, temperature and pressure used during manufacture of ammonia by Haber process.
 L. Relate the terms reversible reactions and dynamic equilibrium.
 M. For the equilibrium, $\text{BaSO}_4(\text{g}) \rightleftharpoons \text{Ba}^{2+}(\text{aq}) + \text{SO}_4^{2-}(\text{aq})$ state the effect of
 a. Addition of Ba^{2+} ion.
 b. Removal of SO_4^{2-} ion
 c. Addition of $\text{BaSO}_4(\text{s})$ on the equilibrium.

3. Explain :

- A. Explain dynamic nature of chemical equilibrium with suitable example.
 B. Relation between K_c and K_p .
 C. State and explain Le Chatelier's principle suitably with reference to
 1. Change in temperature
 2. Change in concentration.
 D. a. Reversible reaction
 b. Rate of reaction
 E. What is the effect of adding chloride on the equilibrium ?
 $\text{AgCl}(\text{g}) \rightleftharpoons \text{Ag}^+(\text{aq}) + \text{Cl}^-(\text{aq})$



Activity :

Prepare concepts maps of chemical equilibrium.

13. Nuclear chemistry and radioactivity

13.1 Introduction: Nuclear chemistry is a branch of physical chemistry :

It is the study of reactions involving changes in atomic nuclei. This branch started with the discovery of natural radioactivity by a physicist Antoine Henri Becquerel (1852-1908). Most of the 20th century research has been directed towards understanding of the forces holding the nucleus together. To understand the changes occurring on the earth, Geologists explore nuclear reactions. Astronomers study nuclear reactions taking place in stars. In biology and medicine, the interactions of radiation emitted from nuclear reactions within the living system are important.

Examples of nuclear reactions are : radioactive decay, artificial transmutation, nuclear fission and nuclear fusion.

We briefly discuss these in this chapter. We have studied the structure of atom in Chapter 4.

13.1.1 Similarity between the solar system and structure of atom: Our solar system is made up of the Sun and planets. The Sun is at the centre of solar system and planets moving round it under the force of gravity. Analogous to this in atomic systems, the forces which hold subatomic particles are attractive electrostatic.

As studied in Chapter 4, the atom consists of tiny central core called nucleus consisting of protons and neutrons and surrounding region of space being occupied by fast moving electrons.

The radius of nucleus is of the order of 10^{-15} m whereas that of the outer sphere is of the order of 10^{-10} m. The size of outer sphere, is 10^5 times larger than the nucleus. There is a large space vacant outside the nucleus.

An element is denoted as A_ZX where X is the symbol of the element. Z equals number of protons and is called atomic number of the element.



Do you know ?

How small is the nucleus in comparison to the rest of atom ?

If the atom were of the size of football stadium, the nucleus at the centre spot would be the size of a pea.

'A' is the mass number or the sum of number of protons and neutrons in an atom. N is the number of neutrons in an atom.

$$A = Z + N$$

The number of neutrons can be obtained by subtracting the atomic number, Z, from the mass number A.

The atomic number, appearing as a subscript to the left of the elemental symbol, gives the number of protons in the nucleus. The mass number written as a superscript to the left of element symbol, gives the total number of nucleons that is the sum of protons (p) and neutrons (n). The most common isotope of carbon, for example, has 12 nucleons : 6 protons and 6 neutrons,

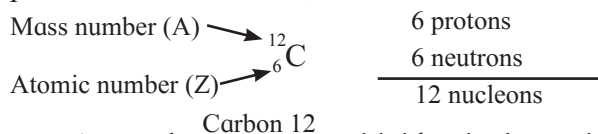

As you know, atoms with identical atomic numbers but different mass numbers are called isotopes. The nucleus of a specific isotope is called **nuclide**.

The charge on the nucleus is $+Ze$ and that of outer sphere is $-Ze$, ('e' is the magnitude of electronic charge). The atom as a whole is, thus, electrically neutral. The mass of an electron is negligible ($1/1837^{\text{th}}$ of the mass of proton) in comparison to proton or neutron. The entire mass of atom is concentrated in its nucleus. The density of nucleus is considerably higher, typically 10^5 times the density of ordinary matter.

The radius of nucleus is given by $R = R_0 A^{1/3}$ where R_0 is constant, common to

all nuclei and its value is 1.33×10^{-15} m. The volume of nucleus, $V \propto R^3$ and hence, $V \propto A$.

13.2 Classification of nuclides

13.2.1 : On the basis of the number of neutrons and protons constituting the nucleus, the nuclides (which refer to atomic nucleus without relation to the outer sphere) are classified as

i. Isotopes : These are nuclides which the same number of protons but different number of neutrons. For example, $^{22}_{11}\text{Na}$, $^{23}_{11}\text{Na}$, $^{24}_{11}\text{Na}$. The number of neutrons in each being 11, 12 and 13, respectively.

ii. Isobars : These are nuclides which have the same mass number and different number of protons and neutrons. For example, $^{14}_6\text{C}$, the number of neutrons in each are 8 and 7, respectively. Likewise ^3_1H and ^3_2He , or $^{14}_6\text{C}$ and $^{14}_7\text{N}$ are the pairs of isobars (Table 13.1).

Table 13.1 : Isobars

Isobars of $A = 3$	^3_1H ($N = 2$), ^3_2He ($N = 1$)
Isobars of $A = 14$	$^{14}_6\text{C}$ ($N = 8$), $^{14}_7\text{N}$ ($N = 7$)
Isobars of $A = 24$	$^{24}_{11}\text{Na}$ ($N = 13$), $^{24}_{12}\text{Mg}$ ($N = 12$)

iii. Mirror nuclei : These are isobars in which the number of protons and neutrons differ by 1 and are interchanged. Examples: ^3_1H and ^3_2He , $^{13}_6\text{C}$ and $^{13}_7\text{N}$

Identify the following nuclides as : isotopes, isobars and isotones ^3_1H , ^4_2He , $^{14}_6\text{C}$, $^{38}_{17}\text{Cl}$, $^{14}_7\text{N}$, $^{24}_{12}\text{Mg}$, $^{35}_{17}\text{Cl}$, $^{32}_{16}\text{S}$, $^{31}_{15}\text{P}$.

iv. Isotones : Isotones are nuclides having the same number of neutrons but different number of protons and hence, different mass numbers. For example, carbon, nitrogen, sodium, magnesium.

$^{13}_6\text{C}$ and $^{14}_7\text{N}$, $^{23}_{11}\text{Na}$ and $^{24}_{12}\text{Mg}$

v. Nuclear isomers : The nuclides with the same number of protons (Z) and neutrons (N) or the same mass number (A) which differ in energy states are called nuclear isomers. For example, $^{60\text{m}}\text{Co}$ and ^{60}Co . An isomer of higher energy is said to be in the meta stable state. It is indicated by writing m after the mass number.

13.2.2 Classification on the basis of nuclear stability

i. Stable nuclides : The number of electrons and the location of nuclei may change in outer sphere but the number of protons and neutrons therein is unchanged.

ii. Unstable or radioactive nuclides : These nuclides undergo spontaneous change forming new nuclides.

13.3 Nuclear stability : Why some nuclei are stable while others are radioactive and undergo spontaneous change? To answer this question we need to know the factors governing stability of the nucleus.

13.3.1 Even-odd nature of number of protons and neutrons

Table 13.2 : Distribution of naturally occurring nuclides.

Number of protons Z	Number of neutrons N	Number of such nuclides
Even	Even	165
Even	Odd	55
Odd	Even	50
Odd	Odd	04

The conclusions drawn from the above data are :

a. Nuclides with even Z and even N are stable. They tend to form proton-proton and neutron-neutron pairs and impart stability to the nucleus. The nuclides with the even Z and even N constitute 85% of earth crust.

b. The number of stable nuclides with either Z or N odd is about one third of those where both are even. These nuclides are less stable than those having even number of protons and neutrons. In these nuclides one nucleon has no partner. This indicates the separate pairing of neutrons and protons. The nucleon pairing does not take place between proton and neutron. Further the nuclides with odd A are nearly the same irrespective of Z or N is odd. This indicates that protons and neutrons behave similarly in the respect of stability.

c. The stable nuclides with odd Z and odd N are only four. These are unstable; which can be attributed to the presence of two unpaired nucleons. Only 2% of the earth's crust consists of such nuclides.

13.3.2 Neutron to Proton ratio (N/Z) :

i. Figure 13.1 shows a plot of the neutron number (N) as a function of proton number (Z) in stable nuclides. A large number of elements have several stable isotopes. Hence, the curve appears as a belt or zone called **Stability zone**. All the stable nuclides fall within this zone. The nuclides which form outside such belt are radioactive. The straight line below the belt represents the ratio N/Z to be nearly unity.

ii. As may be noticed for nuclei lighter than ${}^{40}_{20}\text{Ca}$, one observes the straight line ($N=Z$) passing through the belt. The lighter nuclides are therefore stable (N/Z being 1).

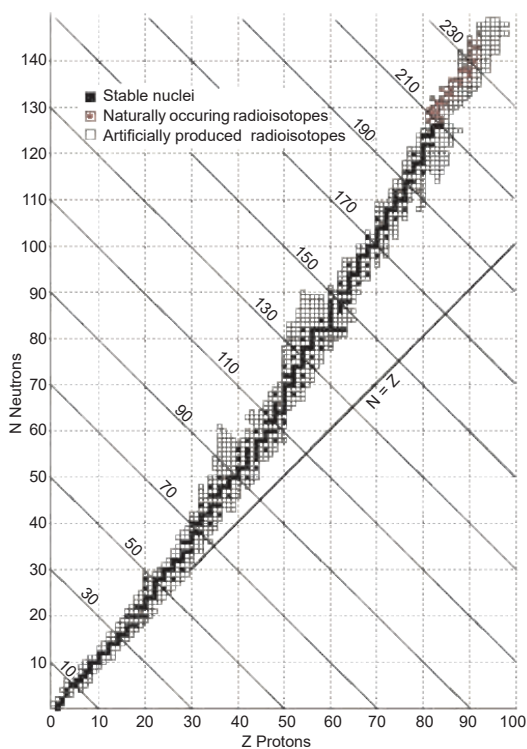

Fig. 13.1 : Neutron to Proton (N/Z) ratio

iii. The N/Z ratio for the stable nuclides heavier than calcium gives a curved appearance to the belt with gradually increase of N/Z (> 1). The heavier nuclides therefore, need more number of neutrons (than protons) to attain stability. What is the reason for this? The heavier nuclides with the increasing number

of protons render large coulombic repulsions. With increased number of neutrons the protons within the nuclei get more separated, which renders them stable.

13.3.3 Magic numbers : The nuclei with 2, 8, 20, 28, 50, 82 and 126 neutrons or protons are particularly stable and abundant in nature. These are magic numbers. Lead (${}^{208}_{82}\text{Pb}$) has two magic numbers, 82 protons and 126 neutrons.

13.3.4 Nuclear Potential : Within the nucleus, all protons are positively charged. What are the consequences of the Coulomb repulsions between these protons?

The distance between two protons present in the nucleus is typically 10^{-15} m. Obviously, the repulsion between them has to be large. This makes protons to go away from each other. Can you imagine what would happen if the coulomb repulsion had been the only force in operation? The nucleus does exist. How?

There are nuclear forces of attraction between all the nucleons holding them together within the nucleus? These are attractions between proton-proton, neutron-neutron and proton-neutron. These attractive forces are independent of the charge on nucleons or p-p, n-n and p-n attractions are equal. These attractive forces operate over short range within the nucleus.

The p-p, n-n and p-n attractions constitute what is called the nuclear potential which is responsible for the nuclear stability.

13.3.5 Nuclear binding energy and mass defect : Binding energy of a nucleus (stable or radioactive) gives a measure of how strongly nucleons are held together within the nucleus.

Atoms are composed of protons, neutrons and electrons. The actual mass of atom was observed to be less than sum of the masses of its constituents. The energy required for holding the nucleons together within the nucleus of an atom is called as the **nuclear binding energy**. It may be defined as the energy required to break the nucleus into its constituents, wherein the binding of electrons to the nucleus has been neglected.

The nucleus holds of protons and neutrons together. During the formation of nucleus, a certain mass is lost. This is known as mass defect, Δm . **An energy equivalent to the mass lost is released during the formation of nucleus. This is called the nuclear binding energy.**

In general, the exact mass of a nucleus is slightly less than sum of the exact masses of the constituent nucleons. The difference is called mass defect. (Δm),

$$\Delta m = \text{Calculated mass} - \text{Observed mass.}$$

The conversion of mass into energy is established through Einstein's equation, $E = mc^2$. where m is the mass of matter converted into energy E and c velocity of light.

Units of nuclear masses and energy : The nuclear mass is expressed in atomic mass unit (u) which is exactly $1/12^{\text{th}}$ of the mass of ^{12}C atom. Thus, $u = 1/12^{\text{th}}$ mass of C - 12 atom = 1.66×10^{-27} kg.

The energy released in the conversion of one u mass into energy is given by :

$$E = mc^2 = (1.66 \times 10^{-27}\text{kg}) \times (3 \times 10^8\text{m s}^{-1})^2$$

Expression for nuclear binding energy :

Consider a nuclide ^A_ZX that contains Z protons and $(A - Z)$ neutrons. Suppose the mass of the nuclide is m . The mass of proton is m_p and that of neutron is m_n .

$$\text{Total mass} = (A-Z) m_n + Z m_p + Z m_e \quad \dots(13.1)$$

$$\begin{aligned} \Delta m &= [(A-Z) m_n + Z m_p + Z m_e] - m \\ &= [(A-Z) m_n + Z (m_p + m_e)] - m \\ &= [(A-Z) m_n + Z m_H] - m \quad \dots(13.2) \end{aligned}$$

where $(m_p + m_e) = m_H = \text{mass of H atom.}$

$$\text{Thus } (\Delta m) = [Zm_p + (A-Z) m_n] - m$$

Where Z is atomic number, A is the mass number, $(A-Z)$ is neutron number, m_p and m_n are masses of proton and neutron, respectively, and m is the mass of nuclide.

The mass defect, Δm is related to binding energy of nucleus by Einstein's equation

$$\Delta E = \Delta m \times c^2$$

where, ΔE is the binding energy, Δm is the mass defect. Nuclear energy is measured in million electron volt (MeV).

The total binding energy is then given by

$$B.E. = \Delta m (u) \times 931.4,$$

where $1.00 u = 931.4 \text{ MeV}$

$$B.E. = 931.4(Zm_H + (A-Z) m_n) - m \quad \dots (13.3)$$

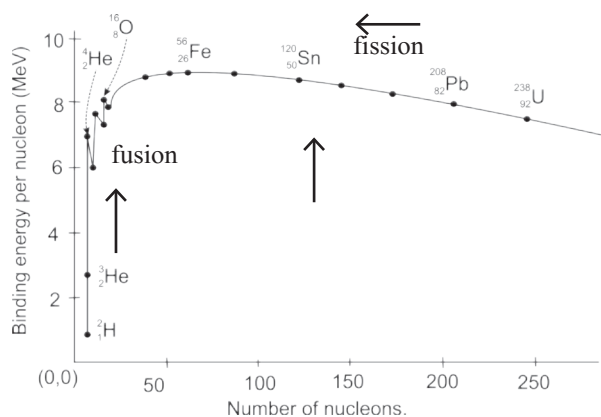

Fig. 13.2 : Binding energy per nucleon

Total binding energy of nucleus containing A nucleons is the $B.E.$. The binding energy per nucleon is then given by,

$$\bar{B} = B.E. / A \quad \dots (13.4)$$

Binding energy per nucleon and nuclear stability : Mean binding energy per nucleon for the most stable isotopes as a function of mass number is shown in Fig. 13.2. This plot leads to the following inferences.

(i) Light nuclides ($A < 30$)

The peaks with A values in multiples of 4. For example, ^4_2He , $^{12}_6\text{C}$, $^{16}_8\text{O}$ are more stable.

(ii) Medium mass nuclides : ($30 < A < 90$)

\bar{B} increases typically from 8 MeV for $A=16$ to nearly 8.3 MeV for A between 28 and 32 and it remains nearly constant 8.5 MeV beyond this and shows a broad maximum. The nuclides falling on the maximum are most stable which in turn possess high \bar{B} values. Accordingly ^{56}Fe with \bar{B} value of 8.79 MeV is the most stable.

(iii) Heavy nuclides ($A > 90$)

\bar{B} decreases from maximum 8.79 MeV to 7.7 MeV for $A \approx 210$, ^{209}Bi is the stable nuclide. Beyond this all nuclides are radioactive (α -emitters).

Problem : 13.1 : Calculate the mean binding energy per nucleon for the formation of $^{16}_8\text{O}$ nucleus. The mass of oxygen atom is 15.994 u. The masses of H atom and neutron are 1.0078 u and 1.0087 u, respectively.

Solution :

i. The mass defect, $\Delta m = Zm_{\text{H}} + (A - Z) m_{\text{n}} - m$

$m_{\text{H}} = 1.0078 \text{ u}$, $m_{\text{n}} = 1.0087 \text{ u}$ and $m = 15.994 \text{ u}$, $Z = 8$, $A = 16$

$\Delta m = 8 \times 1.0078 \text{ u} + 8 \times 1.0087 \text{ u} - 15.994 \text{ u} = 0.137144 \text{ u}$

ii. Total binding energy, B.E. (MeV) = Δm (amu) $\times 931.4$

Hence, B.E. = $0.137144 \times 931.4 = 127.73 \text{ MeV}$

iii. Binding energy per nucleon, $\bar{B} = \frac{\text{BE}}{A}$

Hence, $\bar{B} = \frac{127.73 \text{ MeV}}{16} = 7.98 \text{ MeV/nucleon}$

Calculate the binding energy per nucleon for the formation of ^4_2He nucleus? Mass ^4_2He atom = 4.0026 u.

13.4 Radioactivity : You know that some elements such as uranium and radium are radioactive elements. An element is radioactive if the nuclei of its atoms are unstable. The phenomenon in which the nuclei spontaneously emit a nuclear particle and gamma radiation transforming to a different nuclide is called radioactivity. The elements which undergo nuclear changes are radioactive elements. The radioactivity is the phenomenon related to the nucleus.

The radiations emitted by radioactive elements are : alpha (α), beta (β) and gamma (γ) radiations. Earlier you have studied the properties of α , β and γ rays.



Try this

Prepare a chart of comparative properties of the above three types of radiations.

13.5 Radioactive decay : The probability of decay of a radioelement does not depend on state of chemical combination, temperature, pressure, presence of catalyst or even the age of nucleus.

13.5.1 Rate of decay : Rate of decay of a radioelement denotes number of nuclei of its atoms which decay in unit time. It is also called activity of radioelement.

If dN is the number of nuclei that decay within time interval dt , then rate of decay at any time t is given by

$$\text{rate of decay (activity)} = - \frac{dN}{dt}$$

Why is minus sign required? The number of nuclei decreases with time. So dN is a negative quantity. However the rate of decay is a positive quantity. The negative sign is introduced in the rate expression to make the rate positive. The rate of decay is expressed as disintegrations per second (dps).

13.5.2 Rate law : The rate of decay of a radioelement at any instant is proportional to the number of nuclei (atoms) present at that instant. Thus,

$$- \frac{dN}{dt} \propto N, \text{ or } - \frac{dN}{dt} = \lambda N \quad \dots\dots (13.5)$$

$$\therefore \lambda = - \frac{dN}{dt} \times \frac{1}{N}$$

where $-\frac{dN}{dt}$ being the rate of decay at any time t . N is the number of nuclei present at time t , λ the decay constant. That is the fraction of nuclei decaying in unit time.

13.5.3 Expression for decay constant :

Rearranging the Eq. (13.5)

$$\frac{dN}{N} = - \lambda dt$$

Integrating,

$$\int \frac{dN}{N} = - \int \lambda dt$$

On performing the integration, we get

$$\ln N = - \lambda t + C \quad \dots\dots (13.6)$$

where C is the constant of integration whose value is obtained as follows :

Let N_0 be the number of nuclei present at some arbitrary zero time. At time t , the number of nuclei is N . So at $t = 0$, $N = N_0$. Substituting in Eq. (13.6),

$$\ln N_0 = C.$$

with this value of C , Eq. (13.6) becomes

$$\ln N = -\lambda t + \ln N_0$$

$$\text{or } \lambda t = \ln N_0 - \ln N = \ln \frac{N_0}{N} \quad \dots\dots (13.7)$$

$$\text{Hence, } \lambda = \frac{1}{t} \ln \frac{N_0}{N} \quad \dots\dots (13.8)$$

Converting natural logarithm (\ln) to logarithm to the base 10, the eqn (13.8) becomes

$$\lambda = \frac{2.303}{t} \log_{10} \frac{N_0}{N} \quad \dots\dots (13.9)$$

The Eq. (13.7) can be expressed as $\ln \frac{N}{N_0} = -\lambda t$. Taking antilog of both sides, we get

$$\frac{N}{N_0} = e^{-\lambda t} \text{ or } N = N_0 e^{-\lambda t} \quad \dots\dots (13.10)$$

The Eq. (13.9) and Eq. (13.10) give the decay constant.

13.5.4 Half life of radioelement ($t_{1/2}$): The half life of a radioelement is the time needed for a given number of its nuclei (atoms) to decay exactly to half of its initial value. Each radio isotope has its own half life denoted by $t_{1/2}$ and expressed in seconds, minutes, hours, days or years. At any time t , number of nuclei = N .

At $t = 0$, $N = N_0$. Hence at $t = t_{1/2}$, $N = N_0/2$ substitution of these values of N and t in Eq. (13.9) gives

$$\lambda = \frac{2.303}{t_{1/2}} \log_{10} \frac{N_0}{N_0/2}$$

$$= \frac{2.303}{t_{1/2}} \log_{10} 2 = \frac{2.303}{t_{1/2}} \times 0.3010 = \frac{0.693}{t_{1/2}}$$

$$\text{Hence, } \lambda = \frac{0.693}{t_{1/2}} \text{ or } t_{1/2} = \frac{0.693}{\lambda}$$

13.5.5 Graphical representation of decay

i. From Eq. (13.9)

$$\log_{10} N = \frac{-\lambda}{2.303} t + \log_{10} N_0$$

A plot of $\log_{10} N$ versus t gives a straight line. However, $N \propto \left(-\frac{dN}{dt}\right)$. Hence, instead of $\log_{10} N$ versus t , $\log_{10} \left(-\frac{dN}{dt}\right)$ which is \log_{10} (activity) is plotted versus. The graph is a straight line as shown in Fig. (13.3).

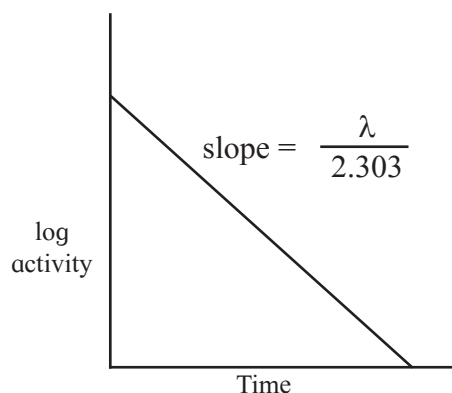

Fig. 13.3 : Plot of \log_{10} activity Vs time

ii. Rate of radioactive decay at any instant is proportional to number of atoms of the radioactive element present at that instant. It is evident that as decay progresses, the number of radioactive atoms decrease with time and so does the rate of decay. A plot of a rate or activity versus t is shown in Fig 13.4.

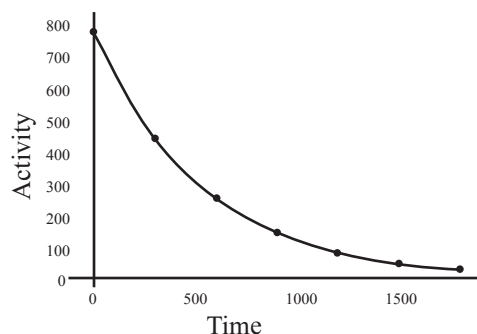

Fig. 13.4 : Plot of activity versus time



Just think

Does half life increase, decrease or remain constant? Explain.

Fig. 13.4 shows a decrease in the rate of decay, that is, decrease in number of radioactive atoms with time.

Problem : 13.2

^{41}Ar decays initially at a rate of 575 Bq. The rate falls to 358 dps after 75 minutes. What is the half life of ^{41}Ar ?

Solution :

$$\lambda = \frac{2.303}{t} \log_{10} \left(\frac{N_0}{N} \right)$$

where $-\frac{dN_0}{dt} = 575 \text{ dps}$ $\int -\frac{dN}{dt}$

358 dps and $t = 75 \text{ min}$.

Hence, $\lambda = \frac{2.303}{75 \text{ min}} \log_{10} \frac{575 \text{ dps}}{358 \text{ dps}}$

$$= 6.32 \times 10^{-3} \text{ min}^{-1}$$

$$t_{1/2} = \frac{0.693}{\lambda} = \frac{0.693}{6.32 \times 10^{-3} \text{ min}^{-1}}$$

$$= 109.7 \text{ min}$$

Problem : 13.3

The half life of ^{32}P is 14.26 d. What percentage of ^{32}P sample will remain after 40 d?

Solution :

$$t_{1/2} = \frac{0.693}{\lambda} = \frac{0.693}{14.26 \text{ d}} = 0.0486 \text{ d}^{-1}$$

Now, $\lambda = \frac{2.303}{t} \log_{10} \left(\frac{N_0}{N} \right)$

$$N_0 = 100, N = ?, t = 40 \text{ d}$$

Hence, $\log_{10} \frac{N_0}{N} = \frac{\lambda t}{2.303}$

$$= \frac{0.0486 \text{ d}^{-1} \times 40 \text{ d}}{2.303} = 0.8441$$

Taking antilog of both sides we get

$$\frac{N_0}{N} = \text{antilog}(0.8441) = 6.984$$

$$\frac{100}{N} = 6.984 \text{ or } N = \frac{100}{6.984} = 14.32$$

% ^{32}P that remains after 40 d = 14.32 %

Problem : 13.4

The half life of ^{34}Cl is 1.53 s. How long does it take for 99.9 % of sample of ^{34}Cl to decay?

Solution :

$$\lambda = \frac{0.693}{t_{1/2}} = \frac{0.693}{1.53 \text{ s}} = 0.453 \text{ s}^{-1}$$

Now, $\lambda = \frac{2.303}{t} \log_{10} \left(\frac{N_0}{N} \right)$

$$N_0 = 100, N = 100 - 99.9 = 0.1, t = ?$$

Hence, $0.453 \text{ s}^{-1} = \frac{2.303}{t} \log_{10} \frac{100}{0.1}$

or $t = \frac{2.303}{0.453 \text{ s}^{-1}} \times \log_{10}(1000)$

$$= \frac{2.303}{0.453 \text{ s}^{-1}} \times 3 = 15.25 \text{ s}$$

Problem : 13.5

The half life of ^{209}Po is 102 y. How much of 1 mg sample of polonium decays in 62 y?

Solution :

$$\lambda = \frac{0.693}{t_{1/2}} = \frac{0.693}{102 \text{ y}} = 6.794 \times 10^{-3} \text{ y}^{-1}$$

$$\lambda = \frac{2.303}{t} \log_{10} \left(\frac{N_0}{N} \right)$$

Hence, $\log_{10} \left(\frac{N_0}{N} \right) = \frac{\lambda t}{2.303}$

or, $\log_{10} \left(\frac{N_0}{N} \right)$

$$= \frac{6.794 \times 10^{-3} \text{ y}^{-1} \times 62 \text{ y}}{2.303} = 0.1829$$

It then follows that

$$\frac{N_0}{N} = \text{antilog}(0.1829) = 1.524$$

$$N = \frac{N_0}{1.524} = \frac{1 \text{ mg}}{1.524} = 0.656 \text{ mg}$$

N the amount that remains after 62 y.

Hence, the amount decayed in

$$62 \text{ y} = 1 \text{ mg} - 0.656 \text{ mg} = 0.344 \text{ mg}$$

13.5.6 Units of radioactivity : Rate of radioactive decay is expressed in dps. The unit for the radioactivity is curie (Ci).

1 Ci = 3.7×10^{10} dps (disintegrations per second)
 Another unit of radioactivity is Becquerel (Bq)
 1 Bq = 1 dps. Thus, 1 Ci = 3.7×10^{10} dps = 3.7×10^{10} Bq

13.6 Modes of decay : Radioelements decay by 3 ways, namely, α - decay, β - decay and γ - emission.

13.6.1 Alpha decay : The emission of α -particle from the nuclei is called α - decay. You have learnt that the charge of an α - particle is +2 and its mass is 4 u. It is identical with helium nucleus and hence an α - particle is designated as ${}^4_2\text{He}$.

In the α - decay process, the parent nucleus ${}^A_Z\text{X}$ emits an α - particle and produces daughter nucleus Y. The parent nucleus thus loses two protons (charge +2) and two neutrons. The total mass lost is 4 u. The daughter nucleus will therefore, have mass 4 units less and charge 2 units less than its parent. The α - decay process is then written as a general equation :

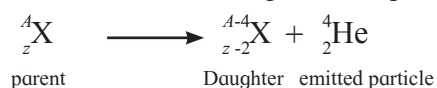

For example,

Radium 226 decays to form Radium 222 :

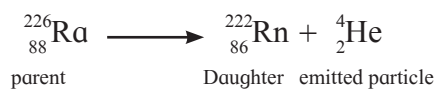

Uranium 238 decays to give Thorium 234 :

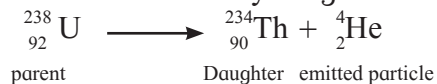

Note that in α - decay, the daughter nucleus formed belongs to an element that occupies two places to the left of the periodic table.

13.6.2 β - decay : β^- - decay : The emission of negatively charged stream of β^- particles from the nucleus is called β^- - decay. You know that β^- - particles are electrons with a charge and mass of an electron, mass being negligible as compared to the nuclei. A nucleus decays by emitting a high speed electron called a beta particle (β), and a new nucleus is formed with the same mass number as the original nucleus with an atomic number that is one unit greater.

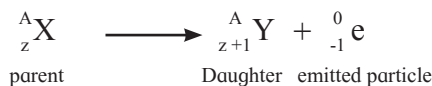

Note that the mass number A does not change, the atomic number changes. Examples of beta decay :

Neptunium 238 decays to form plutonium 238:

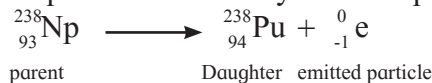

Plutonium 241 decays to form americium 241:

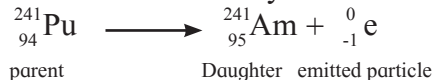

13.6.3 γ - decay : γ -Radiation is almost always accompanies with α and β^- decay processes. In these radioactive transformation, the daughter nucleus is left in which energetically excited state decays to the ground state of product with emission of γ - rays.

For example, ${}^{238}_{92}\text{U} \longrightarrow {}^{234}_{90}\text{Th} + {}^4_2\text{He} + \gamma$
 ${}^{238}_{92}\text{U}$ emits α -particles of two different energies, 4.147 MeV (23%) and 4.195 MeV (77%). When α - particles of energy 4.147 MeV are emitted, ${}^{234}\text{Th}$ is left in an excited state which de-excites to the ground state with emission of γ - ray photons energy 0.048 MeV.

13.7 Nuclear reactions : We have so far discussed natural (spontaneous) nuclear reactions through α and β - decay processes. Now we consider the non-spontaneous (man-made) nuclear reactions or nuclear transmutations.

13.7.1 Transmutation : The nuclear transmutation is transformation of a stable nucleus into another nucleus be it stable or unstable. However, artificial radioactivity is the nuclear transmutation where the product nucleus is radioactive.

Table 13.3 : Comparison of chemical reactions and nuclear reactions

Chemical Reactions	Nuclear Reactions
1. Rearrangement of atoms by breaking and forming of chemical bonds.	1. Elements or isotopes of one elements are converted into another element in a nuclear reaction.
2. Different isotopes of an element have same behaviour.	2. Isotopes of an element behave differently.

3. Only outer shell electrons take part in the chemical reaction.	3. In addition to electrons, protons, neutrons, other elementary particles may be involved.
4. The chemical reaction is accompanied by relatively small amounts of energy. e.g. chemical combustion of 1.0 g methane releases only 56 kJ energy.	4. The nuclear reaction is accompanied by a large amount of energy change. e.g. The nuclear transformation of 1 g of Uranium - 235 releases 8.2×10^7 kJ
5. The rates of reaction is influenced by the temperature, pressure, concentration and catalyst.	5. The rate of nuclear reactions are unaffected by temperature, pressure and catalyst.

13.7.2 Induced or artificial radioactivity :

It is type of nuclear transmutation in which the stable nucleus is converted into radioactive nucleus. The product nucleus decays spontaneously with emission of radiation and particles. For example, the stable element ^{10}B , when bombarded with α - particles, transforms into ^{13}N which spontaneously emits positrons.

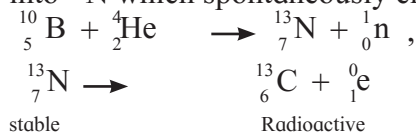

stable

Radioactive

(spontaneous emission of positron)



Try this

${}^{24}\text{Mg}$ and ${}^{27}\text{Al}$, both undergo (α, n) reactions and the products are radioactive. These emit β particles having positive charge (called positrons). Write balanced nuclear reactions in both.

13.7.3 Nuclear fission : Nuclear fission is splitting of the heavy nucleus of an atom into two nearly equal fragments accompanied by release of the large amount of energy. When a uranium nucleus absorbs neutron, it breaks and releases energy (Heat), more neutrons, and other radiation.

For example, ${}^{235}\text{U}$ nucleus captures neutrons and splits into two lighter fragments.

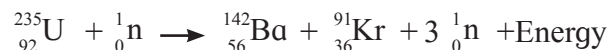

Each fission may lead to different products. The mass of the fission products is less than the parent nucleus. A large amount of energy corresponding to the mass loss is released in each fission. When one Uranium 235 nucleus undergoes fission, three neutrons are emitted, which subsequently disintegrate into three more Uranium nuclei and thereby produce nine neutrons. Such a chain continues by itself. In a very short time enormous amount of energy is liberated, which can be utilized for destructive (dangerous explosives) or peaceful purposes (nuclear reactor - Power Plant).

There is no unique way for fission of ${}^{235}\text{U}$ that produces Ba and Kr, and 400 ways for fission of ${}^{235}\text{U}$ leading to 800 fission products are known. Many of these are radioactive which undergo spontaneous disintegrations giving rise to new elements in the periodic table.

Interestingly each fission emits 2 to 3 neutrons (on an average 2.5 neutrons). Can you imagine what will happen due to neutron emission? Obviously these neutrons emitted in fission cause more fission of the uranium nuclei which yield more neutrons. These neutrons again bring forth fission producing further neutrons. The process continues indefinitely leading to chain reaction which continues even after the removal of bombarding neutrons. Energy released per fission is ~ 200 MeV.



Do you know ?

The chain reaction in fission of ${}^{235}\text{U}$ becomes self sustaining. What is the critical mass of ${}^{235}\text{U}$?

The chain reaction occurs so rapidly that nuclear explosion results. This is what happens in atom bomb.

13.7.5 Nuclear fusion : Energy received by earth from the Sun is the result of nuclear fusion. In the process, the lighter nuclei combine (fuse) together and form a heavy nucleus which is accompanied by an enormous amount of energy. Representative fusion reactions occurring in the Sun and stars are

- i. ${}^1_1\text{H} + {}^1_1\text{H} \longrightarrow {}^2_1\text{H} + {}^0_{-1}\text{e}$
 ii. ${}^1_1\text{H} + {}^2_1\text{H} \longrightarrow {}^3_2\text{He}$
 iii. ${}^3_2\text{He} + {}^3_2\text{He} \longrightarrow {}^4_2\text{He} + 2 {}^1_1\text{H}$
 iv. ${}^3_2\text{He} + {}^1_1\text{H} \longrightarrow {}^4_2\text{He} + {}^0_1\text{e}$

Problem : 13.6

How many α and β - particles are emitted in the following ?

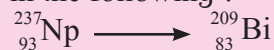

Solution : The emission of one α - particle decreases the mass number by 4 whereas the emission of β - particles has no effect on mass number.

Net decrease in mass number = $237 - 209 = 28$. This decrease is only due to α - particles.

Hence number of α - particles emitted
 $= \frac{28}{4} = 7$

Now the emission of one α -particle decreases the atomic number by 2 and β -particle emission increases by 1.

The net decrease in atomic number = $93 - 83 = 10$

The emission of 7 α -particles causes decrease in atomic number by 14. However the actual decrease is only 10. It means atomic number increases by 4. This increase is due to emission of β -particles. Thus, 4 β - particles are emitted.

Problem : 13.7

Estimate the energy released in the fusion reaction



Given atomic masses : ${}^2\text{H} = 2.041 \text{ u}$

${}^3\text{He} = 3.0160 \text{ u}$, ${}^4\text{He} = 4.0026 \text{ u}$, ${}^1\text{H} = 1.0078 \text{ u}$

Solution :

Mass defect $\Delta m = (\text{mass of } {}^2\text{H} + \text{mass of } {}^3\text{He}) - (\text{mass of } {}^4\text{He} + \text{mass of } {}^1\text{H})$
 $= 2.0141 \text{ u} + 3.0160 \text{ u} - 4.0026 \text{ u} - 1.0078 \text{ u}$
 $= 0.0197 \text{ u}$.

$E = \Delta m (\text{u}) \times 931.4 = 0.197 \text{ u} \times 931.4 = 18.35 \text{ MeV}$.

Problem : 13.8

Half life of ${}^{209}\text{Po}$ is 102 y. How many α -particles are emitted in 1s from 2 mg sample of Po?

Solution :

Activity = number of α (or β) particles emitted

$$= -\frac{dN}{dt} = \lambda N$$

$$\lambda = \frac{0.693}{t_{1/2}} = \frac{0.693}{(102 \times 365 \times 24 \times 3600)\text{s}}$$

$$= 2.154 \times 10^{-10} \text{ s}^{-1}.$$

$$N = \frac{2 \times 10^{-9} \times 6.022 \times 10^{23}}{209}$$

$$= 5.763 \times 10^{12} \text{ atoms of nuclei}$$

$$= -\frac{dN}{dt} = \lambda N$$

$$= 2.154 \times 10^{-10} \text{ s}^{-1} \times 5.763 \times 10^{12} \text{ atoms}$$

$$= 1241 \text{ particles s}^{-1}.$$

Nuclear fusion has certain advantages over nuclear fission. Fusion produces relatively more energy per given mass of fuel.

The only difficulty with fusion is it requires extremely high temperature typically 10^8 K .

13.8 Applications of Radio isotopes

13.8.1 Radiocarbon dating : The technique is used to find the age of historic and archaeological organic samples such as old wood samples and animal or human fossils.

i. Radioactive ${}^{14}\text{C}$ is formed in the upper atmosphere by bombardment of neutrons from cosmic rays on ${}^{14}\text{N}$.



ii. ${}^{14}\text{C}$ combines with atmospheric oxygen to form ${}^{14}\text{CO}_2$ which mixes with ordinary ${}^{12}\text{CO}_2$.

iii. Carbon di oxide is absorbed by plants during photosynthesis. Animals eat plants. Hence, ${}^{14}\text{C}$ becomes a part of plant and animal bodies.



Do you know ?

The oldest rock found so far in Northern Canada is 3.96 billion years old.

iv. As long as plant is alive, the ratio $^{14}\text{C}/^{12}\text{C}$ remains constant. When the plant dies, photosynthesis occurs no more and the ratio $^{14}\text{C}/^{12}\text{C}$ decreases with the decay of ^{14}C (half life 5730 years).



Activity :

You have learnt in Std. 9th, medical, industrial and agricultural applications of radioisotopes. Write at least two applications each.

v. The activity (N) of given wood sample and that of fresh sample of live plant (N_0) is measured. N_0 denotes, the activity of the given sample at the time of death.

vi. The age of the given wood sample, rather the period over which it has remained dead can be determined.

$$t = \frac{2.303}{\lambda} \log_{10} \frac{N_0}{N}$$

$$\text{where } \lambda = \frac{0.693}{5730 \text{ y}} = 1.21 \times 10^{-4} \text{ y}^{-1}.$$

13.8.2 Electrical energy from Nuclear fission

Do you know what is the Nuclear Power ?

It is simply the electricity made from fission of uranium and plutonium.

Why should we care about the Nuclear power?

a. It offers huge environmental benefits in producing electricity.

b. It releases zero carbon dioxide.

c. It releases zero sulfur and nitrogen oxides. These are atmospheric pollutants which pollute the air. Thus it is a clean energy.

We are interested in Nuclear power because :

Fission of 1 gram of uranium-235 produces about 24,000 kW/h of energy.

This is the same as burning 3 tons of coal or 12 barrels of oil, or nearly 5000 m³ of natural gas.

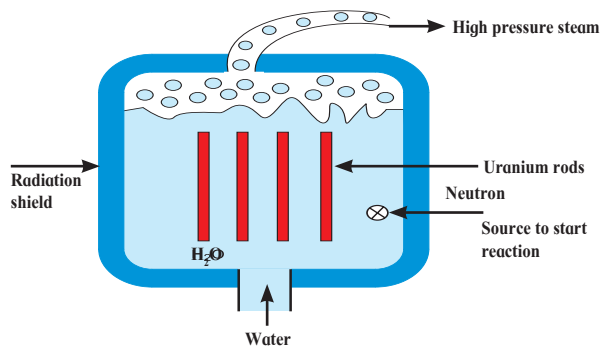

Fig. 13.4 (a) : simplified nuclear reactor

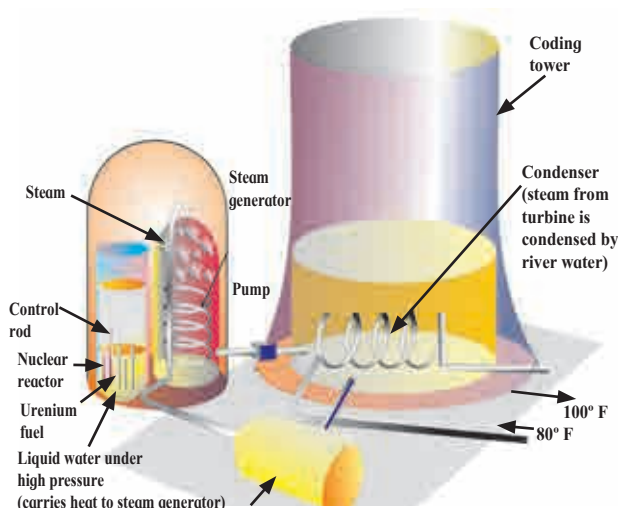

Fig. 13.4 (b) : Schematic diagram of nuclear power plant

The nuclear fission is an alternative energy source. Traditionally, the steam comes from boilers fuelled by oil, gas, or coal. **These sources are depleting. The increasing costs of petroleum suggest we need to depend on the nuclear fission energy for electricity.**

Nuclear Reactor : Nuclear reactor is a device for using atomic energy in controlled manner for peaceful purposes. During nuclear fission energy is released. The released energy can be utilized to generate electricity in a nuclear reactor.

In a nuclear reactor, U^{235} or P^{239} , a fissionable material is stacked with heavy water (D_2O Deuterium oxide) or graphite called moderator. The neutrons produced in the fission pass through the moderator and lose a part of their energy. Subsequently the slow neutrons are captured which initiate new fission.

Table 13.4 (a) : Diagnostic Radioisotopes

	Isotope	Half-life	Emitted particles	Uses	
(i)	$^{51}_{24}\text{Cr}$	Chromium-51	28 days	gamma	spleen imaging
(ii)	$^{59}_{26}\text{Fe}$	Iron-59	45 days	beta, gamma	bone marrow function

Table 13.4 (b) : Therapeutic Radioisotopes

	Isotope	Half-life	Emitted particles	Uses	
(i)	$^{35}_{15}\text{P}$	phosphorus-32	14 days	beta	treatment of leukemia
(ii)	$^{60}_{27}\text{Co}$	cobalt-60	5.3 years	beta, gamma	external radiation source for cancer treatment
(iii)	$^{131}_{53}\text{I}$	iodine-131	8 days	beta, gamma	treatment of thyroid cancer
(iv)	$^{226}_{88}\text{Ra}$	radium- 226	1620 years	beta, gamma	implanted in tumours

Cadmium rods are inserted in the moderator and they have ability to absorb neutrons. The rate of chain reaction thus is controlled. The energy released in such reaction appears as heat and removed by circulating a liquid (coolant). The coolant which has absorbed excess of heat from the reactor is passed over a heat exchanger for producing steam, which is then passed through the turbines to produce electricity. **Thus, the atomic energy produced with the use of fission reaction can be controlled in the nuclear reactor explored for peaceful purposes such as conversion into electrical energy generating power for civilian purposes, ships, submarines etc.**

13.8.3 Applications in medicine :

Hospitals and larger medical clinics typically have a Department of Nuclear Medicine.

Several radioisotopes are used for the treatment of fatal diseases like Cancer.

Table shows medical uses in two different categories, namely diagnostic and therapeutic. For diagnostic purpose, short-lived isotopes are used to limit the exposure time to radiation, while therapeutic radioisotopes are used to destroy abnormal, usually Cancerous cells.

13.8.4 Other applications of radioisotopes :

Radioisotopes find a variety of applications in the diverse areas Agricultural products those are preserved by irradiating with gamma rays from Cobalt - 60 or Caesium - 137.

Another application is radio-tracer technique wherein one or more atoms of a chemical compound are replaced by a radionuclide to trace the path followed by that chemical in the system under study by radioactivity measurement.



Do you know ?

Bhabha Atomic Research Centre (BARC) Mumbai has set up irradiation plants for preservation of agricultural produce such as mangoes, onion and potatoes at Vashi (Navi Mumbai) and Lasalgaon (Nashik).



Internet my friend

1. Isotopic tracer technique : [www.iaea.org>topics>radiotracers](http://www.iaea.org/topics/radiotracers)
2. Collect information about Nuclear Reactions.



Exercises

1. Choose correct option.

A. Identify nuclear fusion reaction

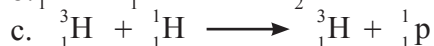
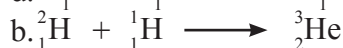

B. The missing particle from the nuclear reaction is

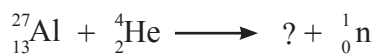

C. ${}^{60}_{27}\text{Co}$ decays with half-life of 5.27 years to produce ${}^{60}_{28}\text{Ni}$. What is the decay constant for such radioactive disintegration ?

a. 0.132 y^{-1} b. 0.138 c. 29.6 y d. 13.8%

D. The radioactive isotope used in the treatment of Leukemia is



E. The process by which nuclei having low masses are united to form nuclei with large masses is

- a. chemical reaction
- b. nuclear fission
- c. nuclear fusion
- d. chain reaction

2. Explain

A. On the basis of even-odd of protons and neutrons, what type of nuclides are most stable ?

B. Explain in brief, nuclear fission.

C. The nuclides with odd number of both protons and neutrons are the least stable. Why ?

D. Referring the stability belt of stable nuclides, which nuclides are $\bar{\beta}$ and β emitters ? Why ?

E. Explain with an example each nuclear transmutation and artificial radioactivity. What is the difference between them ?

F. What is binding energy per nucleon ? Explain with the help of diagram how binding energy per nucleon affects nuclear stability ?

G. Explain with example α - decay.

H. Energy produced in nuclear fusion is much larger than that produced in nuclear fission. Why is it difficult to use fusion to produce energy ?

I. How does N/Z ratio affect the nuclear stability ? Explain with a suitable diagram.

J. You are given a very old sample of wood. How will you determine its age ?

3. Answer the following question

A. Give example of mirror nuclei.

B. Balance the nuclear reaction:

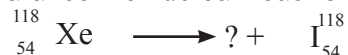

C. Name the most stable nuclide known. Write two factors responsible for its stability.

D. Write relation between decay constant of a radioelement and its half life.

E. What is the difference between an α - particle and helium atom ?

F. Write one point that differentiates nuclear reactions from chemical reactions.

G. Write pairs of isotones and one pair of mirror nuclei from the following :

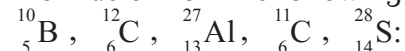

H. Derive the relationship between half life and decay constant of a radioelement.

I. Represent graphically \log_{10} (activity / dps) versus t/s . What is its slope ?

J. Write two units of radioactivity. How are they interrelated ?

K. Half life of ${}^{24}\text{Na}$ is 900 minutes. What is its decay constant ?

L. Decay constant of ${}^{197}\text{Hg}$ is 0.017 h^{-1} . What is its half life ?

M. The total binding energy of ${}^{58}\text{Ni}$ is 508 MeV. What is its binding energy per nucleon ?

N. Atomic mass of ${}^{32}_{16}\text{S}$ is 31.97 u. If masses of neutron and H atom are 1.0087 u and 1.0078 u respectively. What is the mass defect ?

O. Write the fusion reactions occurring in the Sun and stars.

P. How many α and β - particles are emitted in the transmutation

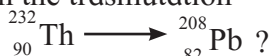

Q. A produces B by α - emission. If B is in the group 16 of periodic table, what is the group of A ?

R. Find the number of α and β - particles emitted in the process

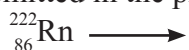

4. Solve the problems

A. Half life of ${}^{18}\text{F}$ is 110 minutes. What fraction of ${}^{18}\text{F}$ sample decays in 20 minutes ?

(Ans. : 0.118)

B. Half life of ${}^{35}\text{S}$ is 87.8 d. What percentage of ${}^{35}\text{S}$ sample remains after 180 d ?

(Ans. : 24.2%)

C. Half life ${}^{67}\text{Ga}$ is 78 h. How long will it take to decay 12% of sample of Ga ?

(Ans. 14.44)

D. 0.5 g Sample of ${}^{201}\text{Tl}$ decays to 0.0788 g in 8 days. What is its half life ?

(Ans. 3.0 d)

E. 65% of ${}^{111}\text{In}$ sample decays in 4.2 d. What is its half life ?

(Ans. : 2.77 d)

F. Calculate the binding energy per nucleon of ${}_{36}^{84}\text{Kr}$ whose atomic mass is 83.913 u. (Mass of neutron is 1.0087 u and that of H atom is 1.0078 u).

(Ans.: 8.7 MeV)

G. Calculate the energy in MeV released in the nuclear reaction

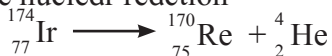

Atomic masses : Ir = 173.97 u,

Re = 169.96 u and

He = 4.0026 u

(Ans. 6.89 MeV)

H. A $3/4$ of the original amount of radioisotope decays in 60 minutes. What is its half life ?

(Ans.: 30 min)

I. How many α - particles are emitted by 0.1 g of ${}^{226}\text{Ra}$ in one year?

(Ans. : 1.154×10^{17})

J. A sample of ${}^{32}\text{P}$ initially shows activity of one Curie. After 303 days the activity falls to 1.5×10^4 dps. What is the half life of ${}^{32}\text{P}$?

(Ans. 14.27 d)

K. Half life of radon is 3.82 d. By what time would 99.9 % of radon will be decayed.

L. It has been found that the Sun's mass loss is 4.34×10^9 kg per second. How much energy per second would be radiated into space by the Sun ?

(Ans.: 3.9×10^{23} kJ/s)

M. A sample of old wood shows 7.0 dps/g. If the fresh sample of tree shows 16.0 dps/g, How old is the given sample of wood ? Half life of ${}^{14}\text{C}$ 5730 y.

(Ans. 6833 y)



Activity :

1. Discuss five applications of radioactivity for peaceful purpose.
2. Organize a trip of Bhabha Atomic Research Centre, Mumbai to learn about nuclear reactor. This will have to be organized through your college.

14. Basic principles of Organic Chemistry



Can you recall?

- Which is the essential element in all organic compounds ?
- What is the unique property of carbon that makes organic chemistry a separate branch of chemistry?
- Which classes of organic compounds are often used in our daily diet ?

14.1 Introduction : Of all the elements, only carbon is able to form an immense array of compounds, ranging from methane having one carbon atom to deoxyribonucleic acid (DNA) with billions of carbon atoms. Crude oil is a complex mixture of compounds called hydrocarbons. The pharmaceutical industry is one of the most important chemical industries that provides us medicines which are organic compounds. We need to study the organic compounds for they are interesting in their own right and their functions are greatly important to life.



Try this

Find out the structures of glucose, vanillin, camphor and paracetamol using internet. Mark the carbon atoms present in them. Assign the hybridization state to each of the carbon and oxygen atom. Identify sigma (σ) and pi (π) bonds in these molecules.

14.2 Structural Representation of organic molecules



Try this

- Draw the structural formula of ethane.
- Draw electron-dot structure of propane.

In the previous standards you learnt how to write structural formulae and electron dot structure of hydrocarbons. Structural formula of a molecule shows all the constituent

atoms denoted with their symbols and all covalent bonds therein represented by a dash joining mutually bonded atoms. For example, structural formula of CH_4 is :

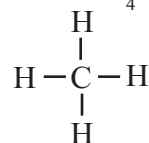

In the electron dot structures of molecules, the valence electrons of all the atoms are shown as dots around them. Two dots drawn in between two atoms indicate one covalent bond between them. For example, the electron dot structure of methane is as shown here



Electron dot structures are called Lewis structures and the dash formula represents simplified Lewis formula. Chemists have developed some more ways to represent organic molecules fulfilling specific requirements.

14.2.1 Condensed formula : The complete structural formula can be further simplified with hiding of some or all the covalent bonds and indicating the number of identical groups attached to an atom by a subscript. The resulting formula of a compound is known as **condensed formula**. For example : condensed formula of ethane can be written as $\text{CH}_3 - \text{CH}_3$ or CH_3CH_3 .

14.2.2 Bond line formula or zig-zag formula

In this representation of a molecule symbols of carbon and hydrogen atoms are not written. The lines representing carbon-carbon bonds are drawn in a zig-zag manner and the terminals of the zig-zag line represent methyl groups. The intersection of lines denotes a carbon atom bonded to appropriate number of hydrogen which satisfy the tetravalency of carbon atoms. For example : propane is represented by the zig-zag formula > . However the heteroatoms or hydrogen atoms bonded to heteroatoms are written clearly. For example : The bond line formula of $\text{C}_2\text{H}_5\text{OH}$ is >OH .

**Try this**

Complete the Table 14.1

Table 14.1 : Representation of structural formula

Dash formula	Condensed formula A	Condensed formula B	Bond line or zig-zag formula
1. $\begin{array}{cccc} \text{H} & \text{H} & \text{H} & \text{H} \\ & & & \\ \text{H}-\text{C}-\text{C}-\text{C}-\text{C}-\text{H} \\ & & & \\ \text{H} & \text{H} & \text{H} & \text{H} \end{array}$	$\text{CH}_3(\text{CH}_2)_2\text{CH}_3$	$\text{CH}_3-\text{CH}_2-\text{CH}_2-\text{CH}_3$	
2.	
3.	$\text{CH}_3(\text{CH}_2)_2\text{CHO}$
4.	$\text{CH}_3\text{CH}_2\text{CH}(\text{CH}_3)\text{OH}$
5. $\begin{array}{c} \text{H} \\ \\ \text{N} \equiv \text{C} - \text{C} - \text{C} \equiv \text{N} \\ \\ \text{OH} \end{array}$

14.2.3 Drawing the molecules in three dimensions : Most organic molecules have three dimensional shapes. Four different methods are used to represent three dimensional molecules on plane paper.

I. Wedge formula : The three dimensional (3-D) view of a molecule can be represented on plane paper by representing the single bonds using solid wedge () , dashed wedges () and normal line (-). A solid wedge is used to represent a bond projecting up from the paper towards the reader. A dashed wedge is used to represent a bond going backward, below the paper away from the reader. Normal lines depict bonds in the plane of the paper. See Fig. 14.1 (for convenience solid and dashed wedge can be replaced by solid/bold and dashed lines.)

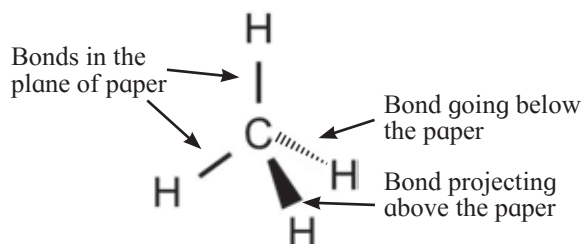
**Fig. 14.1 : Wedge formula**

II. Fischer projection formula or cross formula : In this representation a three dimensional molecule is projected on plane of paper. A Fischer projection formula can

be drawn by visualizing the molecule with its main carbon chain vertical. Each carbon on the vertical chain is represented by a cross. The convention is that the horizontal lines of the cross represent bonds projecting up from the carbon and the vertical lines represent the bonds going below the carbon. Figure 14.2 illustrates the conventions of Fischer projection formula.

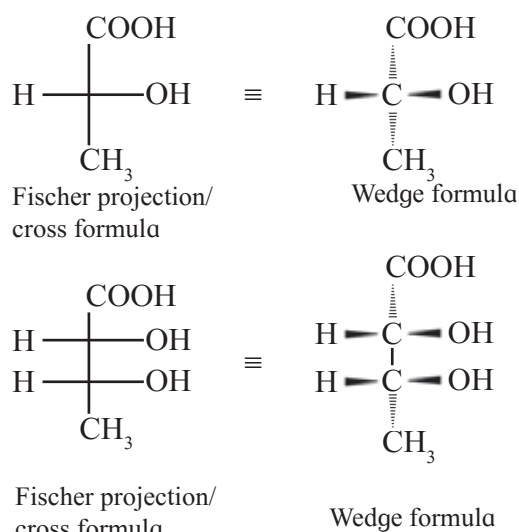
**Fig 14.2 : Fischer projection (cross) formula**

Fischer projection formula is more commonly used in carbohydrate chemistry

III Newman projection formula : In this method projection of a three dimensional molecule on the plane of the paper is drawn by visualizing the molecule by looking through a

C-C single bond. In such case the C-C is not visible. A convention is followed to represent the front carbon by a point and the rear carbon by a circle around it. The remaining three bonds at each of these two carbons are drawn like spokes of a wheel. Conventionally three bonds at the front carbon are shown to radiate from the centre of the circle (which is the front carbon) and three bonds at the rear carbon are shown to radiate from the circumference of the circle. Figure 14.3 shows two representations of ethane ($\text{CH}_3\text{-CH}_3$) molecule by this method.

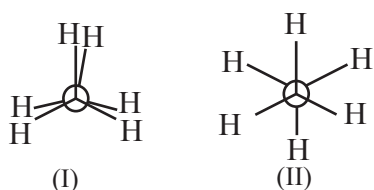

Fig 14.3 : Newman projection formula of ethane

IV. Sawhorse or andiron or perspective formula : In this representation a C-C single bond is represented by a long slanting line. The lower end of the line represents the front carbon and the upper end the rear carbon. The remaining three bonds at the two carbons are shown to radiate from the respective carbons. (As the central C-C bond is drawn rather elongated the bonds radiating from the front and rear carbons do not intermingle.) Figure 14.4 shows two sawhorse (i.e. andiron or perspective) formulae for ethane.

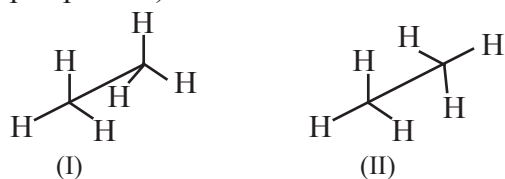

Fig. 14.4 : Sawhorse formula of ethane



Try this

Draw two Newman projection formulae and two sawhorse formulae for the propane molecule.

14.3 Classification of organic compounds :

With so many different molecules to study, it is important to find ways of relating different structures of molecules to their chemical properties. This provides basis for classifying organic compounds. Organic compounds are broadly classified in two ways, on the basis of (i) carbon skeleton and (ii) functional group.



Do you know ?

Molecular models (Fig 14.5) are used for an easier visualisation of three dimensional shapes of organic molecules. Three types of molecular models are common.

i. Frame work model : It emphasizes the skeletal pattern of bonds ignoring size of atoms.

ii. Ball and stick model : In this model a ball represents an atom and stick a bond.

iii. Space filling model : It emphasizes on relative size of each atom. Bonds are not shown. It conveys volume occupied by each atom in the molecule.

Now a days computer graphics can be used for molecular modeling.

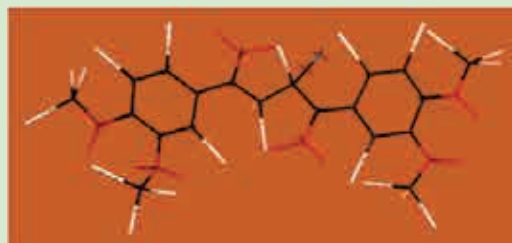

(a) Framework model

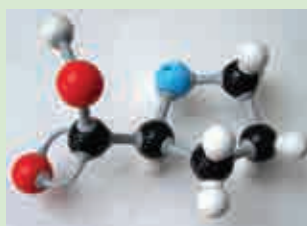

(b) Ball and stick model

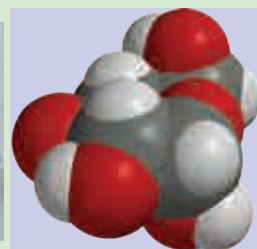

(c) Space filling model

Fig. 14.5 Molecular models

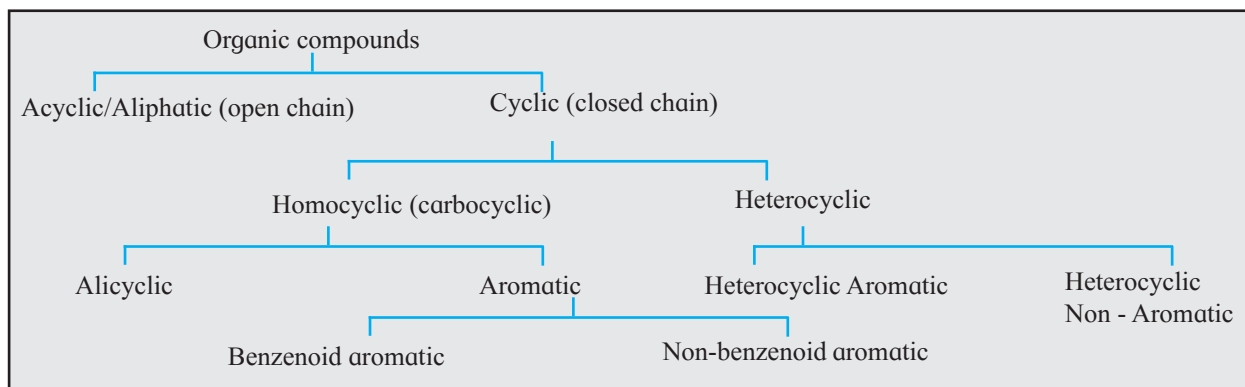

Fig 14.6 : Tree of classification of organic compounds

14.3.1 Classification based on carbon skeleton



Try this

Construct a model of propane (C_3H_8) molecule. Which atoms are on the surface of the molecule? Which atoms lie in the core of the molecule?

The carbon atoms bonded to each other lie in the core of an organic molecule and are described as the carbon skeleton of the molecule. It is the carbon skeleton of a molecule that decides its shape and size. A variety of carbon skeleton are found in different organic compounds and accordingly they are classified into various types as shown in Fig. 14.6

Acyclic or open chain compounds : These are also known as **aliphatic compounds**. Molecules of these compounds have chains of carbon atoms. These may be straight chains formed by carbon atoms bonded to one or two other carbons or branched chains having at least one carbon bonded to three or four other carbons. Table 14.2 shows examples of acyclic compounds.

Table 14.2 : Acyclic/Aliphatic compounds

$CH_3 - CH_2 - CH_3$ propane straight chain	$CH_3 - CH_2 - CH_2 - OH$ n - propyl alcohol
$CH_3 - \underset{\substack{ \\ CH_3}}{CH} - CH_3$ isobutane Branched chain	

Cyclic compounds : These are compounds in which molecules are formed by joining atoms to form ring like structures.

The compounds in which the ring is made of only carbon atoms are known as **homocyclic** or **carbocyclic** compounds. Carbon is an essential atom in any organic molecule. One or more hydrogen atoms are present in most of the organic molecules. All the other atoms that are found in organic molecules are called **heteroatoms**. The cyclic compounds in which the ring includes one or more heteroatoms (oxygen, nitrogen, sulphur etc.) are known as **heterocyclic** compounds.



Try this



Cyclohexene
(a)



Piperidine
(b)



Cyclopentane
(c)



Benzene
(d)



Pyrrole
(e)

- Observe the compounds (a) to (e)
- Identify the compounds those contain a ring of carbon atoms only.
- Identify the compounds in which ring contains at least one atom other than carbon.

Alicyclic compounds : These are cyclic compounds exhibiting properties similar to those of aliphatic compounds. For example : Cyclobutane, cyclohexene. See Fig. 14.7.

Aromatic compounds : Aromatic compounds have special stability. Aromatic compounds containing benzene ring are known as benzenoid aromatics while those not containing benzene ring are called non-benzenoid aromatics. For example : benzene, tropone. See Fig. 14.7

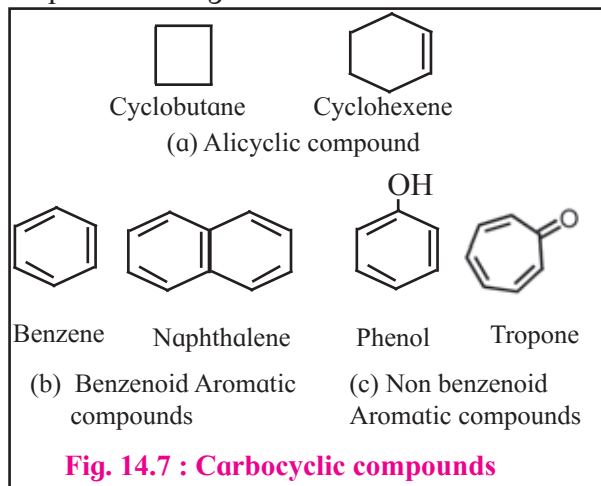
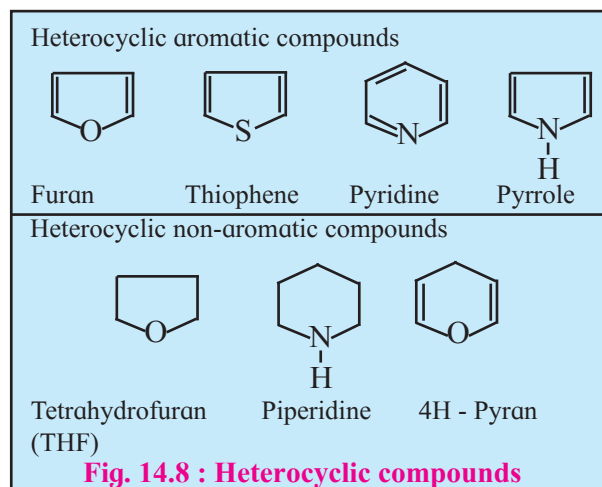

Figure 14.8 illustrates some heterocyclic compounds



14.3.2 Classification based on functional group :



Can you tell?

Consider the following reaction :

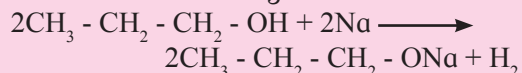

Compare the structure of the substrate propanol with that of the product sodium propoxide. Which part of the substrate, the carbon skeleton or the OH group has undergone a change during the reaction ?

A part of an organic molecule which undergoes change as a result of a reaction is called functional group. In the above illustration, OH is the functional group present in propanol. Inspection of structures of various organic compounds tells us that there are a large variety of functional groups present in them. The second method of classification of organic compounds is based on the nature of functional group present. The resulting individual class is called a **family** named after the constituent functional group. For example: family of alcohols, family of halogen derivatives. Table 14.3 shows some common functional groups with their names, bond structures and examples.

Homologous series : A family of functional group, in turn, comprises different homologous series. A series of compounds of the same family in which each member has the same type of carbon skeleton and functional group, and differs from the next member by a constant difference of one methylene group ($-\text{CH}_2-$) in its molecular and structural formula is called as homologous series. An individual member of a homologous series is called **homologue**. All the members, or homologues of such series are represented by the same general formula.

The members of a particular homologous series possess similar chemical properties those very gradually in their physical properties namely, melting point, boiling point, density, solubility, etc. Table 14.4 illustrates this with the help of homologous series of straight chain aldehydes having general formula $\text{C}_n\text{H}_{2n}\text{O}$.

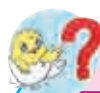

Do you know ?

- **Aliphatic compounds** are named so because of their attraction towards fats.
- **Aromatic compounds** are named so because some of these compounds discovered in early 19th century possessed aroma.

Table 14.3 : Functional groups in organic compounds

Sr. No.	Name of the family/ functional group	structure of the functional group	Example
1.	Halide	- X	CH ₃ Br methyl bromide
2.	Cyanide (or Nitrile)	- C≡N	CH ₃ CN methyl cyanide (or acetonitrile)
3.	Isocyanide	- N [⊖] ≡ C [⊕]	CH ₃ NC methyl isocyanide
4.	Nitro compound/group	$\begin{array}{c} \text{O} \\ \parallel \\ -\text{N}-\text{O} \\ \oplus \quad \ominus \end{array}$	CH ₃ NO ₂ Nitromethane
5.	Alcohol	- OH	CH ₃ OH methyl alcohol
6.	Phenol	Ar - OH	C ₆ H ₅ OH Phenol
7.	Primary amine	- NH ₂	CH ₃ NH ₂ methyl amine
8.	Secondary amine	- NH -	CH ₃ - NH - CH ₃ Dimethyl amine
9.	Tertiary amine	$\begin{array}{c} -\text{N}- \\ \end{array}$	(CH ₃) ₃ N Trimethyl amine
10.	Ether	$\begin{array}{c} \quad \\ -\text{C}-\text{O}-\text{C}- \\ \quad \end{array}$	CH ₃ - O - CH ₃ Dimethyl ether
11.	Aldehyde	$\begin{array}{c} -\text{C}-\text{H} \\ \parallel \\ \text{O} \end{array}$	CH ₃ CHO Acetaldehyde
12.	Ketone	$\begin{array}{c} -\text{C}- \\ \parallel \\ \text{O} \end{array}$	CH ₃ - CO - CH ₃ Acetone
13.	Carboxylic acid	$\begin{array}{c} -\text{C}-\text{OH} \\ \parallel \\ \text{O} \end{array}$	CH ₃ - COOH Acetic acid
14.	Ester	$\begin{array}{c} -\text{C}-\text{O}- \\ \parallel \\ \text{O} \end{array}$	CH ₃ - COOC ₂ H ₅ Ethyl acetate
15.	Amide	$\begin{array}{c} -\text{C}-\text{NH}_2 \\ \parallel \\ \text{O} \end{array}$	CH ₃ - CONH ₂ Acetamide
16.	Secondary amide	$\begin{array}{c} -\text{C}-\text{NH}- \\ \parallel \\ \text{O} \end{array}$	CH ₃ - CO - NH - CH ₃ N-methyl acetamide
17.	Tertiary amide	$\begin{array}{c} -\text{C}-\text{N}- \\ \parallel \quad \\ \text{O} \end{array}$	CH ₃ - CO - N(CH ₃) ₂ N, N - dimethyl acetamide
18.	Acid anhydride	$\begin{array}{c} -\text{C}-\text{O}-\text{C}- \\ \parallel \quad \quad \parallel \\ \text{O} \quad \quad \text{O} \end{array}$	CH ₃ - CO - O - CO - CH ₃ Acetic anhydride
19.	Acyl chloride	$\begin{array}{c} -\text{C}-\text{Cl} \\ \parallel \\ \text{O} \end{array}$	CH ₃ - COCl Acetyl chloride
20.	Sulphonic acid	$\begin{array}{c} \text{O} \\ \parallel \\ -\text{S}-\text{O}-\text{H} \\ \parallel \\ \text{O} \end{array}$	C ₆ H ₅ SO ₃ H Benzene sulphonic acid
21.	Alkene/Olfin	$\begin{array}{c} \diagup \quad \diagdown \\ \text{C}=\text{C} \\ \diagdown \quad \diagup \end{array}$	CH ₂ = CH ₂ Ethylene
22.	Alkyne	- C≡C -	CH≡CH Acetylene
23.	Alkane	No functional group	CH ₃ - CH ₃ Ethane

Problem 14.1 : Alkanes constitute a homologous series of straight chain saturated hydrocarbons. Write down the structural formulae of the first five homologues of this series. Write their molecular formulae and deduce the general formula of such homologous series.

Solution :

The first five homologues are generated by adding one $-\text{CH}_2-$ at a time, starting with the first homologue CH_4 .

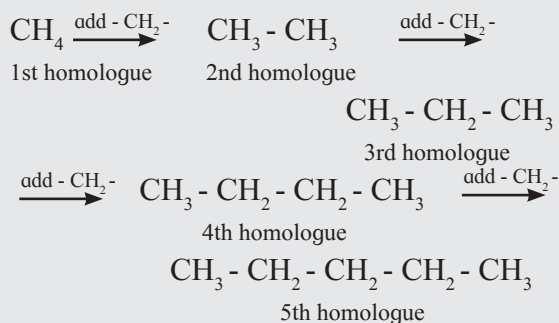

By counting carbon and hydrogen atoms in the five homologues we get their molecular formulae as CH_4 , C_2H_6 , C_3H_8 , C_4H_{10} and C_5H_{12} . Comparing these molecular formulae, the following general formula is deduced : $\text{C}_n \text{H}_{2n+2}$.

Problem 14.2 : Write down structural formulae of (a) the third higher and (b) the second lower homologue of $\text{CH}_3\text{CH}_2\text{COOH}$.

Solution :

a. structural formula of the third higher homologue is obtained by adding three $-\text{CH}_2-$ units to the carbon chain of given structure.

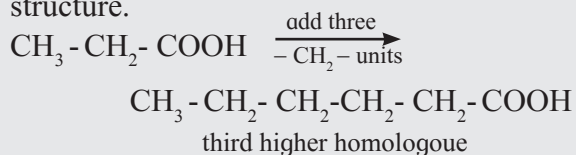

b. structural formula of the second lower homologue is obtained by removing two $-\text{CH}_2-$ units from the carbon chain of the given structure.

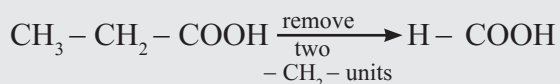

Remember

The saturated (sp^3) carbons in a molecule are labelled as primary, secondary, tertiary and quaternary in accordance with the number of other carbons bonded to it by single bonds.

- **Primary carbon** (1^0) is bonded to only one other carbon. For example: both the carbons in ethane $\text{CH}_3\text{-CH}_3$.
- **Secondary carbon** (2^0) is bonded to two other carbons. For example: the middle carbon in propane $\text{CH}_3\text{-CH}_2\text{-CH}_3$.
- **Tertiary Carbon** (3^0) is bonded to three other carbons. For example: the middle carbon in isobutane $\text{CH}_3\text{CH}(\text{CH}_3)_2$.
- **Quaternary Carbon** (4^0) is bonded to four other carbons. For example: the middle carbon in neo-pentane $\text{C}(\text{CH}_3)_4$.

14.4 Nomenclature of organic compounds

14.4.1 Common/trivial names

As organic chemistry developed, attempts were made to devise a name for every organic compound. These old names are now referred to as common / trivial names. Common name of a compound usually has some history behind and usually accepted on account of its long usage. Though a systematic method of nomenclature was developed later, common names are still useful and in many cases can not be avoided, particularly for commonly used commercial organic compounds. Stem names of certain common organic compounds are given in Table 14.5.

Table 14.4 : Homologous series of straight chain aldehydes

Name	Number of carbons	Molecular formula $C_n H_{2n} O$	Condensed structural formula	Boiling point
Formaldehyde	$n = 1$	CH_2O	$H - \overset{O}{\parallel}{C} - H$	$- 21^\circ C$
Acetaldehyde	$n = 2$	C_2H_4O	$CH_3 - \overset{O}{\parallel}{C} - H$	$21^\circ C$
Propionaldehyde	$n = 3$	C_3H_6O	$CH_3 - CH_2 - \overset{O}{\parallel}{C} - H$	$48^\circ C$
Butyraldehyde	$n = 4$	C_4H_8O	$CH_3 - (CH_2)_2 - \overset{O}{\parallel}{C} - H$	$75^\circ C$
Valeraldehyde	$n = 5$	$C_5H_{10}O$	$CH_3 - (CH_2)_3 - \overset{O}{\parallel}{C} - H$	$103^\circ C$

Table 14.5 : Trivial names of some organic compounds

Structural formula	Common Name/ Trivial Name
$CH_3 - CH_2 - CH_2 - CH_3$	n - Butane
$\begin{array}{c} CH_3 - CH - CH_3 \\ \\ CH_3 \end{array}$	Isobutane
$C_6H_5NH_2$	Aniline
$\begin{array}{c} CH_3 - CH - COOH \\ \\ OH \end{array}$	Lactic acid
$CHCl_3$	Chloroform
$CH \equiv CH$	Acetylene
$C_2H_5 - O - C_2H_5$	Diethyl ether
CH_3COOH	Acetic acid
$\begin{array}{c} H - C - H \\ \\ O \end{array}$	Formaldehyde
$\begin{array}{c} CH_3 - CH - COOH \\ \\ NH_2 \end{array}$	Glycine
$\begin{array}{c} CH_2 - CH - CH_2 \\ \quad \quad \\ OH \quad OH \quad OH \end{array}$	Glycerol

14.4.2 IUPAC Nomenclature: With the rapidly growing number of organic compounds with increasingly complicated structures it becomes difficult to name them. Some confusion can be created when the same compound is named differently. In due course of time **International Union of Pure and Applied Chemistry (IUPAC)** was founded (1919)

and a systematic method of nomenclature for organic compounds was developed under its banner. This system of nomenclature is accepted and widely used all over the world today. This system gives the unique name to each organic compound.

To arrive at the IUPAC name of an organic compound, its structure is considered to be made of three main parts : parent hydrocarbon, branches and functional groups. The IUPAC names of a compound are obtained by modifying the name of its parent hydrocarbon further incorporating names of the branches and functional groups as prefix and suffix. For doing this, certain rules were formulated by IUPAC. We consider the IUPAC rules for naming saturated and unsaturated hydrocarbons, simple monocyclic hydrocarbons, simple mono and polyfunctional compounds and substituted benzenes in the following.

14.4.3 IUPAC names of straight chain alkanes : The homologous series of straight chain alkanes forms the parent hydrocarbon part of the IUPAC names of aliphatic compounds. The IUPAC name of a straight chain alkane is derived from the number of carbon atoms it contains. Table 14.6 gives the list of the IUPAC names of first twenty straight chain alkanes. It may be noted that the stem names of first four members are accepted as their IUPAC names.

Table 14.6 : IUPAC names of the first twenty alkanes

Number of carbons	Molecular formula	Condensed formula	IUPAC name
1	CH ₄	CH ₄	Methane
2	C ₂ H ₆	CH ₃ - CH ₃	Ethane
3	C ₃ H ₈	CH ₃ - CH ₂ - CH ₃	Propane
4	C ₄ H ₁₀	CH ₃ - (CH ₂) ₂ - CH ₃	Butane
5	C ₅ H ₁₂	CH ₃ - (CH ₂) ₃ - CH ₃	Pentane
6	C ₆ H ₁₄	CH ₃ - (CH ₂) ₄ - CH ₃	Hexane
7	C ₇ H ₁₆	CH ₃ - (CH ₂) ₅ - CH ₃	Heptane
8	C ₈ H ₁₈	CH ₃ - (CH ₂) ₆ - CH ₃	Octane
9	C ₉ H ₂₀	CH ₃ - (CH ₂) ₇ - CH ₃	Nonane
10	C ₁₀ H ₂₂	CH ₃ - (CH ₂) ₈ - CH ₃	Decane
11	C ₁₁ H ₂₄	CH ₃ - (CH ₂) ₉ - CH ₃	Undecane
12	C ₁₂ H ₂₆	CH ₃ - (CH ₂) ₁₀ - CH ₃	Dodecane
13	C ₁₃ H ₂₈	CH ₃ - (CH ₂) ₁₁ - CH ₃	Tridecane
14	C ₁₄ H ₃₀	CH ₃ - (CH ₂) ₁₂ - CH ₃	Tetradecane
15	C ₁₅ H ₃₂	CH ₃ - (CH ₂) ₁₃ - CH ₃	Pentadecane
16	C ₁₆ H ₃₄	CH ₃ - (CH ₂) ₁₄ - CH ₃	Hexadecane
17	C ₁₇ H ₃₆	CH ₃ - (CH ₂) ₁₅ - CH ₃	Heptadecane
18	C ₁₈ H ₃₈	CH ₃ - (CH ₂) ₁₆ - CH ₃	Octadecane
19	C ₁₉ H ₄₀	CH ₃ - (CH ₂) ₁₇ - CH ₃	Nonadecane
20	C ₂₀ H ₄₂	CH ₃ - (CH ₂) ₁₈ - CH ₃	Icosane

14.4.4 IUPAC names of branched saturated hydrocarbons

The branches or the side chains in saturated hydrocarbons are alkyl groups or alkyl substituents. Before looking at the IUPAC nomenclature of the branched saturated hydrocarbons, we look at the naming of alkyl groups.

Alkyl groups : An alkyl group may be a straight or branched chain. A **straight chain alkyl group** is generated by removing one hydrogen atom from the terminal carbon of an alkane molecule and is named by replacing 'ane' of the alkane by 'yl'. Some straight chain alkyl groups are listed in Table 14.7.

Table 14.7 : Straight chain alkyl groups

Alkane		Alkyl group		
Molecular formula	IUPAC name	Condensed formula	IUPAC name	Abbrided name
CH ₄	methane	- CH ₃	methyl	Me
C ₂ H ₆	ethane	- CH ₂ - CH ₃	ethyl	Et
C ₃ H ₈	propane	- (CH ₂) ₂ - CH ₃	propyl	Pr
C ₄ H ₁₀	butane	- (CH ₂) ₃ - CH ₃	butyl	Bu
C ₁₀ H ₂₂	decane	- (CH ₂) ₉ - CH ₃	decyl	-

A **branched chain alkyl group** is obtained by removing a hydrogen atom from any one of the nonterminal carbons of an alkane or any hydrogen atom from a branched alkane. Stem names of branched alkyl groups containing upto four carbons are used in IUPAC names (see Table 14.8)

Table 14.8 : Trivial names of small branched alkyl groups

Structural formula	Name
$\text{CH}_3 - \underset{\text{ }}{\text{CH}} - \text{CH}_3$	Isopropyl
$\text{CH}_3 - \underset{\text{ }}{\text{CH}} - \text{CH}_2 - \underset{\text{ }}{\text{CH}_3}$	Isobutyl
$\text{CH}_3 - \underset{\text{ }}{\text{CH}} - \text{CH}_2 - \text{CH}_3$	sec-Butyl
$\text{CH}_3 - \underset{\text{ }}{\underset{\text{ }}{\text{C}}} - \underset{\text{ }}{\text{CH}_3}$	tert-Butyl

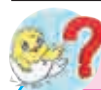

Do you know ?

The group C_6H_5- () is named as phenyl group and abbreviated as Ph.

Rules for IUPAC nomenclature of branched saturated hydrocarbons :

1. Select the longest continuous chain of carbon atoms to be called the parent chain. All other carbon atoms not included in this chain constitute side chains or branches or alkyl substituents. For example :

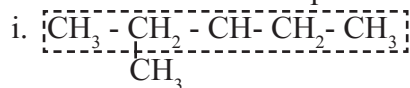

Parent chain has five carbon atoms and $-\text{CH}_3$ group is alkyl substituent

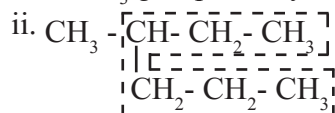

Parent chain has six 'C' atoms and methyl group is the alkyl substituent

If two chains of equal length are located, the one with maximum number of substituents is selected as the parent chain. For example :

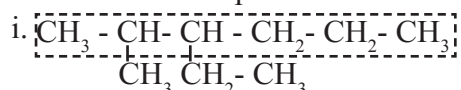

Parent chain hexane with two alkyl substituents (correct parent chain)

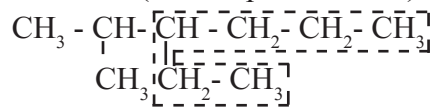

Parent chain hexane with one alkyl substituent (incorrect chain)

2. The parent chain is numbered from one end to the other to locate the position, called locant number of the alkyl substituent. The **numbering** is done in that direction which will result in lowest possible locant numbers .

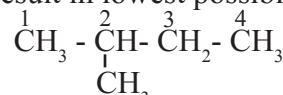

(locant number : 2 ~ proper numbering)

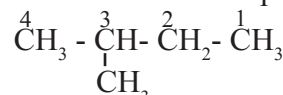

(locant number : 3 ~ improper numbering)

3. Names of the alkyl substituents are added as **prefix** to the name of the parent alkane. Different alkyl substituents are listed in alphabetical order with each substituent name preceded by the appropriate **locant number**. The name of the substituent is separated from the locant number by **a hyphen**.

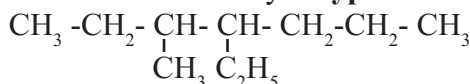

The name is 4-ethyl-3-methylheptane and not 3-methyl-4-ethylheptane.

4. When both the numberings give the same set of locants, that numbering is chosen which gives **smaller locant** to the substituent having **alphabetical priority**. Thus the IUPAC name of the following structure is 3-ethyl-4-methylhexane and **not** 3-methyl-4-ethylhexane.

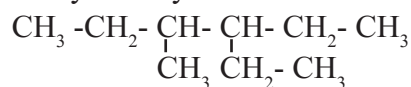

5. If two or more identical substituents are present the prefix **di** (for 2), **tri** (for 3), **tetra** (for 4) and so on, are used before the name of the substituent to indicate how many identical substituents are there. The locants of identical substituents are listed together, separated by **commas**.

There must be as many numbers in the name as the substituents. A digit and an alphabet is separated by hyphen. The prefixes di, tri, tetra, sec and tert are ignored in alphabetizing the substituent names. Substituent and parent hydrocarbon names are joined into **one word** (note that isopropyl comes before methyl).

6. Branched alkyl group having no accepted trivial name is named with the longest continuous chain beginning at the point of attachment as the base name. Carbon atom of this group attached to parent chain is numbered 1. Name of such substituent is enclosed in bracket. For example :

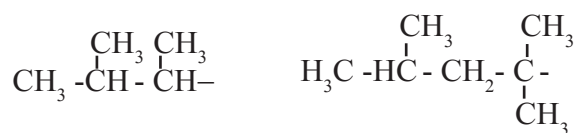

1, 2 di-methylpropyl 1, 1, 3- trimethylbutyl

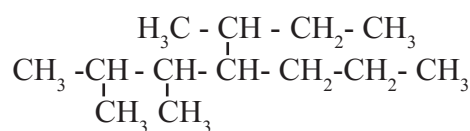

2, 3 - dimethyl - 4 - (1methylpropyl)heptane

14.4.5 IUPAC nomenclature of unsaturated hydrocarbons (Alkenes and Alkynes)

While writing IUPAC names of alkenes and alkynes following rules are to be followed in addition to rules already discussed.

1. The longest continuous **chain must include carbon-carbon multiple bond**. Thus the longest continuous chains in I and II contain four and six carbons, respectively.

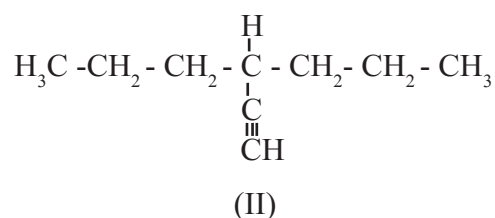
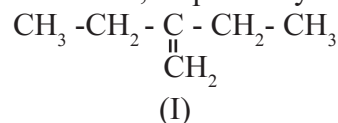

2. Numbering of this chain must be done such that carbon-carbon **multiple bond** has the **lowest possible locant** number.

Proper numbering	improper numbering
$\overset{4}{\text{CH}_3} - \overset{3}{\text{CH}_2} - \overset{2}{\text{CH}} = \overset{1}{\text{CH}_2}$	$\overset{1}{\text{CH}_3} - \overset{2}{\text{CH}_2} - \overset{3}{\text{CH}} = \overset{4}{\text{CH}_2}$
$\overset{1}{\text{HC}} \equiv \overset{2}{\text{C}} - \overset{3}{\text{CH}_2} - \overset{4}{\text{CH}_3}$	$\overset{4}{\text{HC}} \equiv \overset{3}{\text{C}} - \overset{2}{\text{CH}_2} - \overset{1}{\text{CH}_3}$

Problem 14.3 :

Complete the following table

Structural formula	Numbering	Prefix	IUPAC Name
$\text{CH}_3 - \underset{\text{CH}_3}{\text{CH}} - \text{CH}_2 - \text{CH}_3$	$\overset{1}{\text{C}} - \overset{2}{\underset{\text{C}}{\text{C}}} - \overset{3}{\text{C}} - \overset{4}{\text{C}}$	2 - methyl	2 - methylbutane
$\text{CH}_3 - \overset{\text{CH}_3}{\underset{\text{CH}_3}{\text{C}}} - \text{CH}_3$	$\overset{1}{\text{C}} - \overset{2}{\underset{\text{C}}{\text{C}}} - \overset{3}{\text{C}}$	2, 2 - dimethyl	2, 2-dimethylpropane
$\text{CH}_3 - \underset{\text{CH}_3}{\text{CH}} - \underset{\text{CH}_3}{\text{CH}} - \underset{\text{CH}_3}{\text{CH}_2}$			
$\text{CH}_3 - \underset{\text{CH}_3}{\text{CH}} - \underset{\text{CH}_2 - \text{CH}_3}{\text{CH}} - \text{CH}_2 - \text{CH}_2 - \text{CH}_3$			
$\text{CH}_3 - \underset{\text{C}_2\text{H}_5}{\text{CH}} - \underset{\text{C}_2\text{H}_5}{\text{CH}} - \text{CH}_2 - \text{CH}_2 - \text{CH}_3$			
$\begin{array}{c} \text{C}_2\text{H}_5 \quad \text{C}_2\text{H}_5 \\ \diagdown \quad / \\ \text{C} \\ / \quad \diagdown \\ \text{C}_2\text{H}_5 \quad \text{C}_2\text{H}_5 \end{array}$			

3. The ending 'ane' of alkane is replaced by 'ene' for an alkene and 'yne' for an alkyne.

4. **Position of carbon atom** from which **multiple bond** starts is indicated by smaller locant number of two multiply bonded carbons before the ending 'ene' or 'yne' For example :

$\text{CH}_3 - \text{CH}_2 - \text{CH} = \text{CH}_2$ but-1-ene	$\text{HC} \equiv \text{C} - \text{CH}_2 - \text{CH}_3$ but-1-yne
--	--

5. If the multiple bond is equidistant from both the ends of a selected chain then carbon atoms are numbered from that end which is nearer to **first branching**. For example :

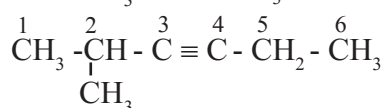
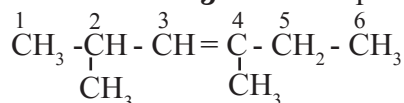

6. If the parent chain contains two double bonds or two triple bonds, then it is named as **diene** or **diyne**. In all these cases 'a' of 'ane' (alkane) is retained.

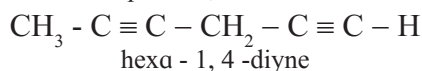
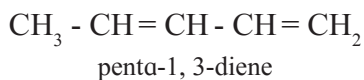

7. If the parent chain contains both double and triple bond, then carbon atoms are numbered from that end where multiple bond is nearer. Such systems are named by putting 'en' ending first followed by 'yne'. The number indicating the location of multiple bond is placed before the name.

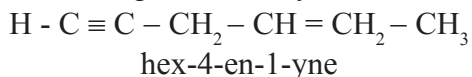
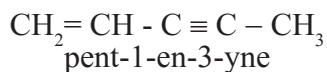

8. If there is a **tie** between a double bond and a triple bond, the double bond gets the lower number.

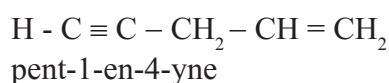

14.4.6 IUPAC Names of simple monocyclic hydrocarbons : A saturated monocyclic hydrocarbon is named by attaching prefix 'cyclo' to the name of the corresponding open chain alkane.

For example :

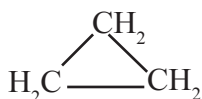

Cyclopropane



Cyclopentane

An unsaturated monocyclic hydrocarbon is named by substituting 'ene', 'yne' etc. for 'ane' in the name of corresponding cycloalkane.

For example:



Cyclohexene



Cyclopentene

If side chains are present then the above discussed rules are applied. **Numbering** of the ring carbon is **started from a side chain**. For example :

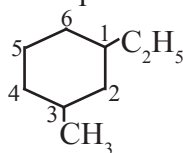

1-ethyl-3-methylcyclohexane

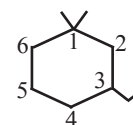

3-ethyl-1,1-dimethylcyclohexane

If alkyl groups contain greater number of carbon atoms than the ring, the compound is named as derivative of alkane. Ring is treated as substituent. For example :



3-cyclopropylhexane

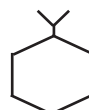

isopropylcyclohexane

14.4.7 IUPAC nomenclature of compounds containing one or more functional groups :

The IUPAC names of compounds containing one or more functional groups include the names of the functional groups as prefix and/ or suffix. Table 14.8 shows how names of functional groups are modified when included as prefix or suffix in the IUPAC name. Some functional groups appear only as prefixes and are shown in Table 14.9. (a and b)

Table 14.9 : Modified names of functional groups as in IUPAC nomenclature

a. Functional groups appearing prefix and suffix

Functional group	Prefix	Suffix
- COOH	carboxy	- oic acid
- COOR	alkoxycarbonyl	- oate
- COCl	chlorocarbonyl	- oyl chloride
- CONH ₂	carbamoyl	- amide
- CN	cyano	- nitrile
- CHO	formyl	- al
- CO -	oxo	- one
- OH	hydroxy	- ol
- NH ₂	amino	- amine

b. Functional groups appearing only as prefix

Functional group	Prefix
- NO ₂	nitro
- X (- F, - Cl, - Br, - I.)	halo (fluro, chloro, bromo, iodo)
- OR (- OCH ₃ , - OC ₂ H ₅ , etc)	alkoxy (methoxy, ethoxy, etc.)

Naming monofunctional compounds : When a molecule contains only one functional group, the longest carbon chain containing that functional group is identified as the parent chain and numbered so as to give the smallest locant number to the carbon bearing the functional group. The parent name is modified by applying appropriate suffix. Location of the functional group is indicated where necessary and when it is NOT '1'.

For example :

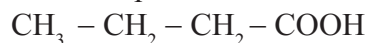

butanoic acid (No need to mention -1-)



propanenitrile (No need to mention -1-)

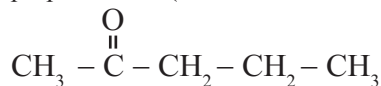

pentan-2-one (Necessary to mention -2-)

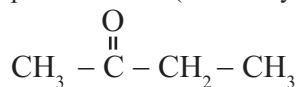

butanone (No need to mention -2-)

When the functional group cannot be used as suffix, and can be only the prefix, the molecule is named as parent alkane carrying the functional group as substituent at specified carbon. For example :

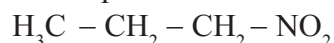

1 - Nitropropane

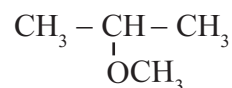

2- Methoxypropane

Polyfunctional compounds : The organic compounds possessing two or more functional groups (same or different) in their molecules are called polyfunctional compounds. When there are two or more different functional groups, one of them is selected as the **principal functional group** and the others are considered as substituents. The principal functional group is used as suffix of the IUPAC name while the other substituents are written with appropriate perfixes. The principal functional group is decided on the basis of the following order of priority.

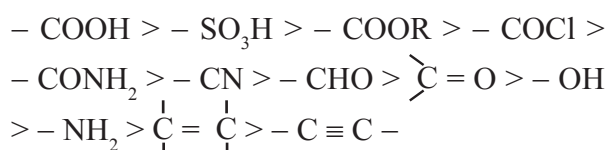

IUPAC Rules for naming mono or polyfunctional compounds

i. The longest carbon **chain containing** or bearing the single or the **principal functional group** is identified as parent chain. Ether is named as alkoxyalkane. While naming it, the larger alkyl group is chosen as parent chain.

Numbering of parent chain is done so as to give the **lowest** possible **locant** numbers to the carbon atom of this functional group.

ii. The name of the parent hydrocarbon is modified adequately with **appropriate suffix** in accordance with the single/principal functional group.

iii. Names of the **other functional groups** (if any) are attached to this modified name as **prefixes**. The locant numbers of all the functional groups are indicated before the corresponding suffix/prefix. The carbon atom in -COOR, -COCl, -CONH₂, -CN and -CHO is C - 1 by rule and therefore, is not mentioned in the IUPAC name.

Problem 14.4 : Write IUPAC names for the following structures :

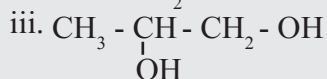
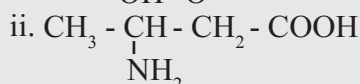
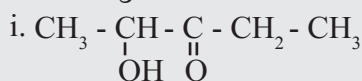

Solution :

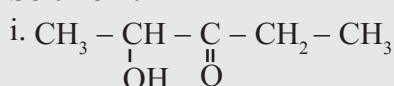

Here the principal functional group, ketone is located at the C-3 on the five carbon chain. The -OH group, the hydroxyl substituent is at C-2. Therefore the IUPAC name is 2-hydroxypentan-3-one.

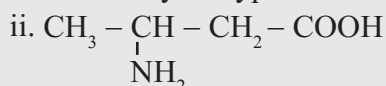

Here the principal functional group is carboxylic acid. The amino substituent is located at C-3 on four carbon chain. Therefore the IUPAC name is 3-aminobutanoic acid.

14.4.8 IUPAC nomenclature of substituted benzene

I. Monosubstituted benzene : The IUPAC name of a monosubstituted benzene is obtained by placing the name of substituent as prefix to the parent skeleton which is benzene. For example :

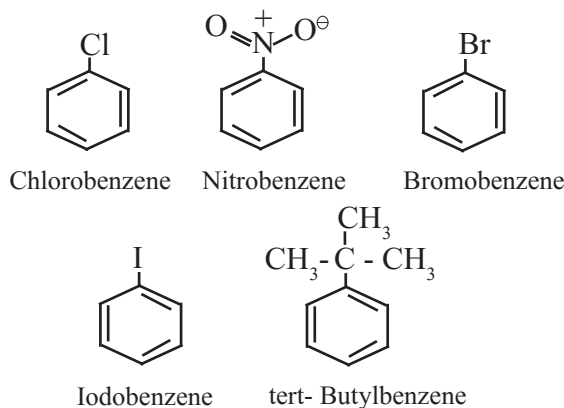

Some monosubstituted benzenes have trivial names which may show no resemblance with the name of the attached substituent group. For example, methylbenzene is known as **toluene**, aminobenzene as aniline, hydroxybenzene as phenol and so on. The common names written in the bracket are also used universally and accepted by IUPAC.

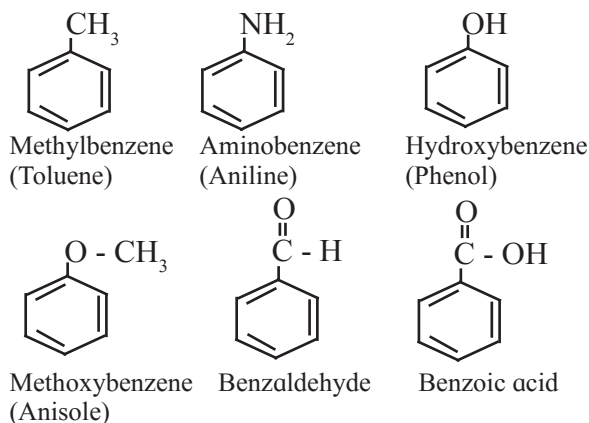

If the alkyl substituent is larger than benzene ring (7 or more carbon atoms) the compound is named as phenyl-substituted alkane.

For example :

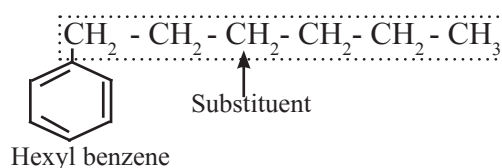
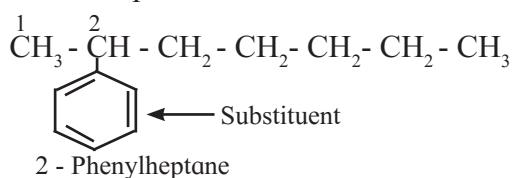

Benzene ring can as well be considered as substituent when it is attached to an alkane with a functional group.

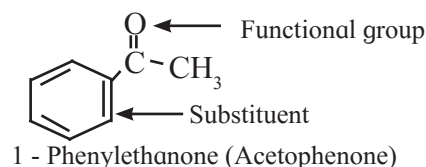
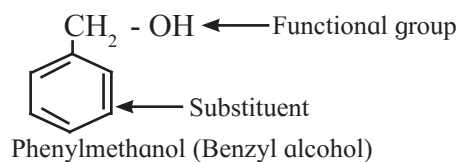
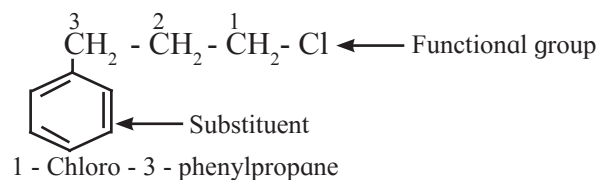

II. Disubstituted benzene derivatives :

Common names of the three possible isomers of disubstituted benzene derivatives are given using one of the prefixes ortho (o-), meta (m-) or para (p-).

IUPAC system, however, uses numbering instead of prefixes, o-, m-, or p-.

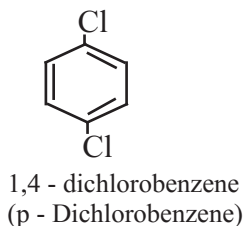
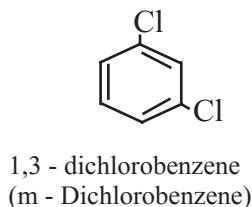
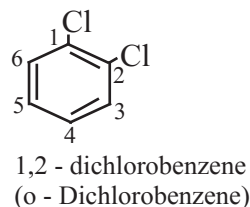

If two substituents are different, then they enter in alphabetical order.

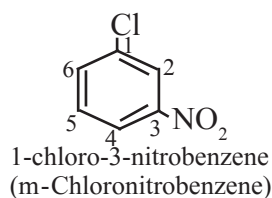
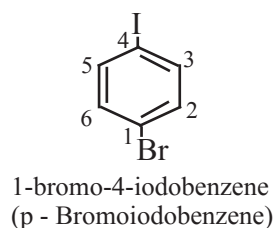

If one of the two groups gives special name to the molecule then the compound is named as derivative of that special compound.

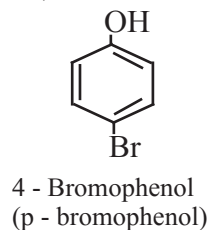
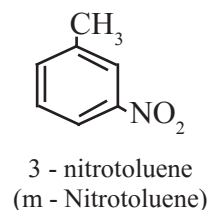
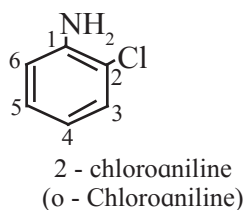

III. Trisubstituted benzene derivatives : If more than two substituents are attached to benzene ring, numbers are used to indicate their relative positions following the alphabetical order and lowest locant rule. In some cases, common name of benzene derivatives is taken as parent compound. For example :

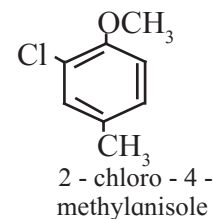
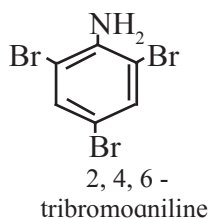
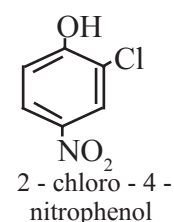
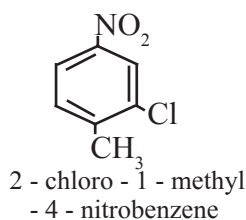
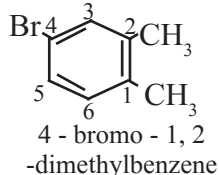
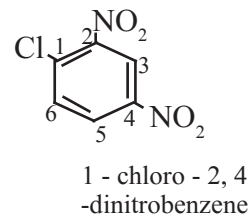
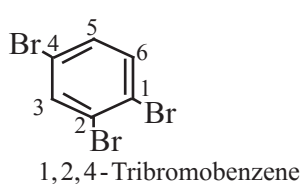

14.5 Isomerism



Activity :

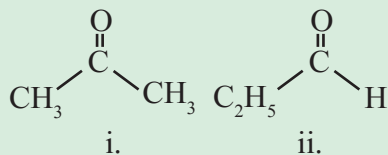

- Observe the structural formulae (i) and (ii)
- Find out their molecular formulae
- What is the difference between them ?
- What is the relation between the two compounds represented by these structural formulae ?

The phenomenon of existence of two or more compounds possessing the same molecular formula is known as **isomerism**. Such compounds are known as isomers of each other. Two types of isomerism are observed in the organic compounds, namely, **structural isomerism** and **stereoisomerism**. When two or more compounds have the same molecular formula but different structural formulae, it is called structural isomerism. On the other hand, when different compounds have the same structural formula but different relative arrangement of groups / atoms in space, that

is, different spatial arrangement of groups / atoms it is called stereoisomerism. In this chapter we are going to look at some details of only structural isomerism.

14.5.1 Structural isomerism

We have seen in the beginning of this chapter that the structural formula describes the sequence in which the constituent atoms of a molecule are bonded and the nature of the bonds between them. **When two or more compounds have same molecular formula and different structural formula they are said to be structural isomers of each other. The phenomenon is known as structural isomerism.** Structural isomerism is further classified as **chain isomerism, position isomerism, functional group isomerism, metamerism and tautomerism**. Figure 14.9 shows the tree of various types of isomerism.

a. Chain isomerism : When two or more compounds have the same molecular formula but different parent chain or different carbon skeleton, it is referred to as chain isomerism and such isomers are known as chain isomers. For example : Butane ($\text{CH}_3 - \text{CH}_2 - \text{CH}_2 - \text{CH}_3$) and 2-methylpropane [$\text{CH}_3 - \text{CH}(\text{CH}_3)_2 - \text{CH}_3$] are chain isomers of each other as they have different carbon skeletons and the same molecular formula C_4H_{10} .

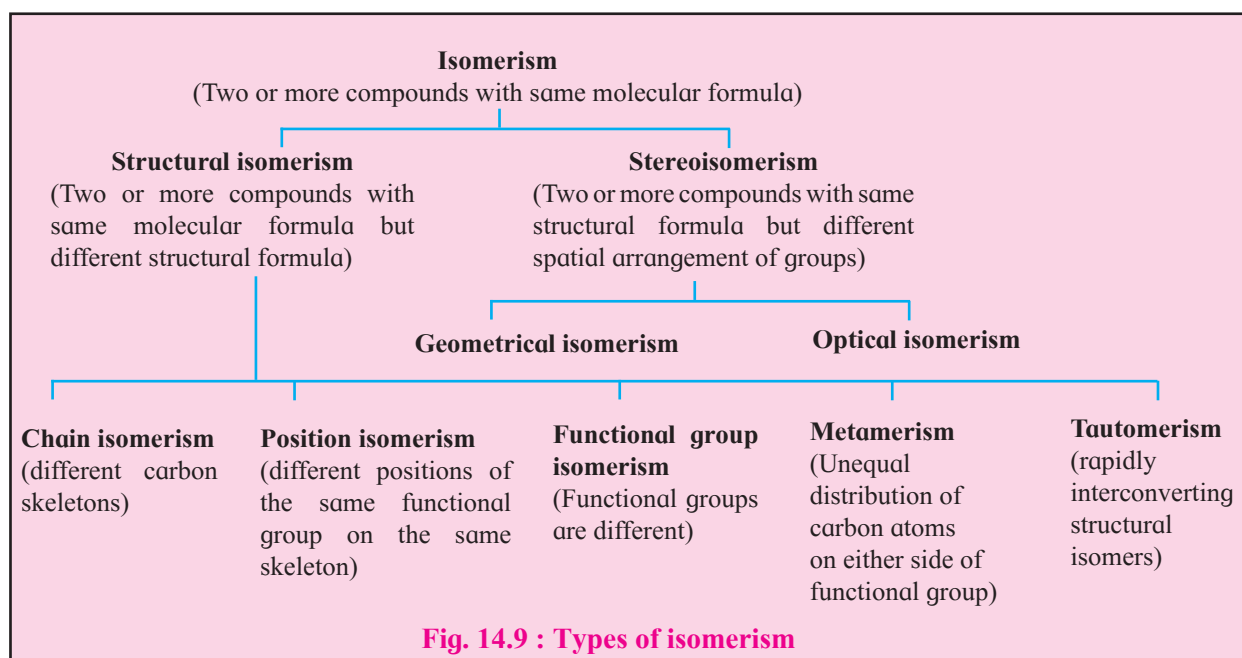

Fig. 14.9 : Types of isomerism

b. Position isomerism : The phenomenon in which different compounds having the same functional groups at different positions on the parent chain is known as position isomerism.

For example : But-2-ene [$\text{CH}_3 - \text{CH} = \text{CH} - \text{CH}_3$] and but-1-ene [$\text{CH}_2 = \text{CH} - \text{CH}_2 - \text{CH}_3$] are position isomers of each other as they have the same molecular formula C_4H_8 and the same carbon skeleton but the double bonds are located at different positions.

c. Functional group isomerism : The phenomenon in which different compounds with same molecular formula have different functional groups is known as functional group isomerism. For example : Dimethylether ($\text{CH}_3 - \text{O} - \text{CH}_3$) and ethyl alcohol ($\text{CH}_3 - \text{CH}_2 - \text{OH}$) have same molecular formula $\text{C}_2\text{H}_6\text{O}$ but the former has ether ($-\text{O}-$) functional group and the latter has alcohol ($-\text{OH}$) functional group.

d. Metamerism : Different compounds with the same molecular formula and the same functional group, but having unequal distribution of carbon atoms on either side of the functional group is referred to as metamerism and the isomers are known as metamers. For example : Ethoxyethane ($\text{CH}_3 - \text{CH}_2 - \text{O} - \text{CH}_2 - \text{CH}_3$) and methoxypropane ($\text{CH}_3 - \text{O} - \text{CH}_2 - \text{CH}_2 - \text{CH}_3$) have the same molecular formula $\text{C}_4\text{H}_{10}\text{O}$ and the same functional group ether but have different distribution of carbon atoms attached to etheral oxygen. These are metamers of each other.

e. Tautomerism : Same compounds exist as a mixture of two or more structurally distinct molecules which are in rapid equilibrium with each other. This phenomenon is referred to as tautomerism. Such interconverting isomers are called tautomers. In nearly all the cases, it is the proton which shifts from one atom to another atom in the molecule to form its tautomer.

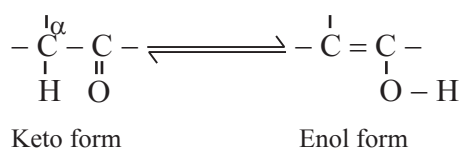

For example : **Keto-enol tautomerism** is very common form of tautomerism. It is found in carbonyl compounds. Here a hydrogen atom shifts reversibly from the α -carbon of the keto form to oxygen atom of the enol.

14.6 Theoretical basis of organic reactions :

All the organic molecules primarily contain various types of covalent bonds between the constituent atoms. During an organic reaction, molecules of the reactant undergo change in their structure. A covalent bond at a carbon atom in the reactant is broken and a new covalent bond is formed at it, giving rise to the product. Often this change is brought about by means of another reactant. The reactant that provides carbon to the new bond is called **substrate**. The other reactant which brings about this change is called **reagent**. In case both the reactants provide carbon atoms to a new bond, the reactant considered is called substrate. Apart from the product of interest some other products are formed in a reaction. These are called **byproducts**. For example :

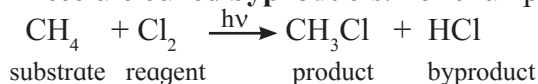

Covalent bonds are made of valence electrons of the constituent atoms. Redistribution of valence electrons of constituent atoms results in the **bond breaking** or **bond forming** processes along the organic reaction; and which are usually not instantaneous. As a result, the overall organic reaction is punctuated by formation of one or more unstable species called **intermediates**. Overall the organic reaction is often a **multi-step process**.

A sequential account of (i) the electron movement taking place during each step (ii) the bond cleavage and/or bond formation (iii) accompanying changes in energy and shapes of various species and (iv) rate of the overall reaction. The individual steps, constitute the **reaction mechanism**. The knowledge of mechanism of a reaction is useful for **understanding the reactivity** of the concerned organic compounds and, in turn, helpful for **planning synthetic strategies**.

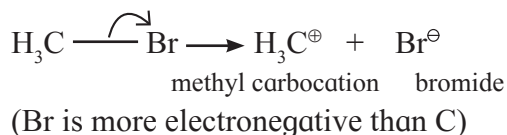

Heterolysis is favoured in polar solvents. In methyl bromide, bromine is more electronegative. Thus heterolysis of methyl bromide results in formation of methyl carbocation and bromide anion.

A carbon atom having sextet of electrons and a positive charge is known as **carbocation** (earlier called carbonium ion). Carbocations are highly unstable and reactive species formed as intermediates in many organic reactions.

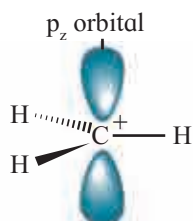

Shape of methyl carbocation

The central carbon atom of a carbocation is sp^2 hybrid state and has trigonal planar geometry. The p_z atomic orbital is vacant and is perpendicular to the plane containing the three sigma bonds at the carbon.

Carbocations are classified as primary (1°), secondary (2°) and tertiary (3°). The observed stability of alkyl carbocations follows the order :

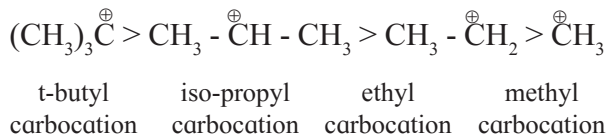

Heterolytic bond fission generates a species called **carbanion** in which carbon gets the shared pair of electrons. This happens when a carbon atom is bonded to the electropositive atom.

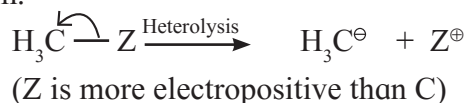

The central carbon atom of a carbanion has completed octet of electrons and a negative charge. The carbanion is unstable and reactive which is formed as the reaction intermediate. Heterolytic fission is favoured in the polar solvents. The organic reactions proceed via heterolytic fission known as **heteropolar / polar / ionic reactions**. Most organic reactions taking place in solutions follow ionic mechanism.



Can you tell?

Some bond fissions are described in the following table. For each of them, show the movement of electron/s using curved arrow notation. Classify them as homolysis or heterolysis and identify the intermediate species produced as carbocation, carbanion or free radical.

Bond fission	Types of cleavage	Intermediate
$\text{CH}_3 - \text{Cu} \longrightarrow \text{CH}_3^{\ominus} + \text{Cu}^{\oplus}$	heterolysis	carbanion
$\text{C}_6\text{H}_5 - \text{O} - \text{O} - \text{C}_6\text{H}_5 \longrightarrow 2\text{C}_6\text{H}_5\dot{\text{O}}$
$\text{CH}_3 - \overset{\text{O}}{\parallel}{\text{C}} - \text{CH}_2 - \text{H} + \overset{\ominus}{\text{O}}\text{H} \longrightarrow \text{CH}_3 - \overset{\text{O}}{\parallel}{\text{C}} - \overset{\ominus}{\text{C}}\text{H}_2 + \text{H}_2\text{O}$
$\text{CH}_3 - \overset{\text{CH}_3}{\underset{\text{CH}_3}{\text{C}}} - \text{Br} \longrightarrow \overset{\text{CH}_3}{\underset{\text{CH}_3}{\text{C}}}^{\oplus} + \text{Br}^{\ominus}$
$\text{CH}_3 - \text{CN} \longrightarrow \overset{\oplus}{\text{C}}\text{H}_3 + \overset{\ominus}{\text{C}}\text{N}$

14.6.2 Types of reagent



Can you recall?

1. What is meant by 'reagent' ?
2. Identify the 'reagent', 'substrate', 'product' and 'byproduct' in the following reaction.



The **polar organic reactions** are brought about by two types of reagents. Depending upon their ability to accept or donate electrons from or to the substrate, reagents are classified as (i) Electrophiles (E^\oplus) (ii) Nucleophiles ($Nu:$) **Electrophiles** (meaning electron loving species) accept electrons from the substrate. Thus electrophiles are electron seeking species. This is because they themselves are electron deficient. For example ; a positively charged ion such as Br^\oplus or a neutral species having a vacant orbitals such as AlCl_3 .

Nucleophiles (nucleus seeking species) give away electrons to the substrate. This is because nucleophiles are electron rich species. For example : negatively charged species such as OH^\ominus or neutral species such as $\text{H}_2\ddot{\text{O}}$, having lone pair of electrons.

Problem 14.5 : Identify the nucleophile and electrophile from NH_3 and CH_3^\oplus . Also indicate the nucleophilic and electrophilic centres in them. Justify.

Solution : The structural formulae of two reagents showing all the valence electrons are :

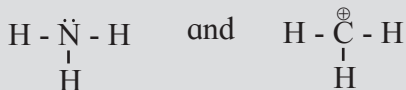

Thus NH_3 contains N with a lone pair of electrons which can be given away to another species. Therefore NH_3 is a nucleophile and 'N' in it is the nucleophilic centre. The CH_3^\oplus is a positively charged electron deficient species having a vacant orbital on the carbon. It is an electrophile. The 'C' in it is the electrophilic centre.

A polyatomic electrophile has an electron deficient atom in it called the **electrophilic centre**, while a polyatomic nucleophile has an electron rich atom in it is called the **nucleophilic centre**. For example : the electrophilic centre of the electrophile AlCl_3 is Al which has only 6 valence electrons. The nucleophilic centre of the nucleophile H_2O is 'O' which has two lone pairs of electrons.

A nucleophile attacks the electrophilic centre in the substrate and brings about a nucleophilic reaction. On the other hand an electrophile attacks a nucleophilic centre in the substrate and brings about an electrophilic reaction. This principle is illustrated in the following simple reaction though, it is not an organic reaction.



Here the nucleophilic centre $\ddot{\text{N}}$ in the nucleophile NH_3 attacks the electrophilic centre 'B' in the electrophile BF_3 and gives the product.

14.6.3 Electronic effects in organic reaction

We noted earlier that in polar organic reactions the nucleophilic centre in a nucleophile attacks the electrophilic centre in the substrate whereas the electrophilic centre in an electrophile attacks the nucleophilic centre in the substrate. **How electrophilic or nucleophilic centre generated in a neutral substrate ?** This happens because of displacement of valence electrons within some organic molecules, which results in their polarization. **The displacement of valence electrons resulting in polarization of an organic molecule is called electronic effect.** The electronic effect that occurs in the **ground state** is **permanent** effect. This takes place due to influence of certain atom or substituent or certain structural feature present in the molecule. **Inductive effect** and **resonance effect** are two examples of permanent electronic effect.

On the other hand the electron displacement effect occurring in a substrate due to approach of the attacking reagent is a **temporary effect**. This type of electronic effect is called **electromeric effect or polarisability effect**. We consider various types of electronic effects in the following sections.

14.6.4 Inductive effect



Can you recall?

- How is covalent bond formed between two atoms ?
- Consider two covalently bonded atoms Q and R where R is more electronegative than Q. Will these atoms share the electron pair equally between them ?
- Represent the above polar covalent bond between Q and R using fractional charges δ^{\oplus} and δ^{\ominus} .

We learnt earlier that covalent bond between two atoms differing in their electronegativity is polar covalent bond. For example : the covalent bond between carbon and more electronegative chlorine is a polar covalent bond. **When an organic molecule has a polar covalent bond in its structure, polarity is induced in adjacent carbon-carbon single bonds too. This is called inductive effect.** Consider, for example, the chloroethane molecule :



In this molecule a positive polarity is developed on C^2 by inductive effect of the Cl atom bonded to C^1 . Normally the $\text{C}^2 - \text{C}^1$ bond would not be expected to be polar as it is a covalent bond between two atoms of the same element carbon. Yet this bond acquires some polarity, because of the presence of chlorine atom in the molecule. Chlorine being more electronegative than carbon, the $\text{C}^1 - \text{Cl}$ bond is a polar covalent bond with partial negative charge on Cl and equal amount of partial positive charge on C^1 . As the C^1 is further bonded to C^2 , the positive polarity of C^1 pulls the shared pair of electrons of the $\text{C}^2 - \text{C}^1$ bond

more towards itself. As a result a part of partial positive charge produced on C^1 is transferred to C^2 . This results in developing a still smaller positive charge on C^2 . In other words, the electron density gets displaced towards the chlorine atom not only along the $\text{C}^1 - \text{Cl}$ bond, but also along the $\text{C}^2 - \text{C}^1$ bond due to the inductive effect of Cl. This is represented as :

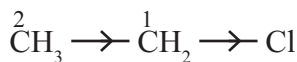

The **arrow head** put in the centre of the **bond** is used to **represent the inductive effect**. The direction of the arrow head indicates the direction of the permanent electron displacement taken place along the sigma bond in the ground state.

Inductive effect of an influencing group is transferred to subsequent carbon atoms along the chain of C - C bonds, as it decreases rapidly as the number of intervening C - C bonds increases and becomes negligibly small beyond three bonds. This can be represented as

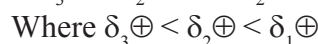
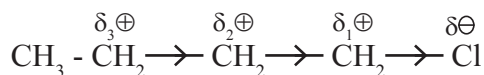

The direction of the inductive effect of a bonded group depends upon whether electron density of the bond is withdrawn from the bonded carbon or donated by the bonded carbon. According to this ability the groups substituents are classified as either **electron withdrawing** (accepting) or **electron donating** (releasing) groups with respect to hydrogen.

In the above example, electron displacement takes place towards chlorine. This means that Cl withdraws electron density from the carbon chain and is electron withdrawing. Chlorine is said to exert an **electron withdrawing inductive effect or negative inductive effect (-I effect)** on the carbon chain. Some other groups having - I effect are - NO_2 (nitro), - CN (cyano), - COOH (carboxy), - COOR (ester), - OAr (aryloxy).

On the other hand alkyl groups ($-\text{CH}_3$, $-\text{CH}_2-\text{CH}_3$) are considered as groups exerting **electron releasing inductive effect (+I effect) on the carbon chain**.

Problem 14.6 : Consider the following molecules and answer the questions, $\text{CH}_3-\text{CH}_2-\text{CH}_2-\text{Cl}$, $\text{CH}_3-\text{CH}_2-\text{CH}_2-\text{Br}$, $\text{CH}_3-\text{CH}_2-\text{CH}_2-\text{I}$.

(i) What type of inductive effect is expected to operate in these molecules ?

(ii) Identify the molecules from these three, having the strongest and the weakest inductive effect.

Solution : (i) The groups responsible for inductive effect in these molecules are $-\text{Cl}$, $-\text{Br}$ and $-\text{I}$, respectively. All these are halogen atoms which are more electronegative than carbon and therefore all of them exert $-I$ effect, that is, electron withdrawing inductive effect.

(ii) The $-I$ effect of halogens is due to their electronegativity. A decreasing order of electronegativity in these halogens follows $\text{Cl} > \text{Br} > \text{I}$. Therefore the strongest $-I$ effect is expected in $\text{CH}_3-\text{CH}_2-\text{CH}_2-\text{Cl}$, while the weakest $-I$ effect is expected for $\text{CH}_3-\text{CH}_2-\text{CH}_2-\text{I}$.

Problem 14.7 : Which of the $\text{CH}_3-\text{CHCl}_2$ and $\text{CH}_3\text{CH}_2\text{Cl}$ is expected to have stronger $-I$ effect ?

Solution : The group exerting $-I$ effect in $\text{CH}_3\text{CH}_2\text{Cl}$ is one $-\text{Cl}$ while in $\text{CH}_3-\text{CHCl}_2$ there are two $-\text{Cl}$ atoms. Therefore $\text{CH}_3-\text{CHCl}_2$ is expected to have strong $-I$ effect.

14.6.5 Resonance structures



Try this

1. Draw a bond line structure of benzene (C_6H_6)
2. How many $\text{C}-\text{C}$ and $\text{C}=\text{C}$ bonds are there in this structure ?
3. Write down the expected values of the bond lengths of the carbon carbon bonds in benzene (refer to Table 5.7).

The cyclic structure of benzene incorporating three alternating $\text{C}-\text{C}$ single bonds and $\text{C}=\text{C}$ double bonds implies two distinct bond length of 154 pm and 133 pm respectively (refer to Table 5.2 and see Fig. 14.10). Experimental measurements show that benzene has a regular hexagonal shape and all the six carbon bonds, have the same bond length of 138 pm which is intermediate between $\text{C}-\text{C}$ single bond and $\text{C}=\text{C}$ double bond. This means that all the six carbon carbon bonds in benzene are equivalent, unlike what appears from the single Lewis structure.

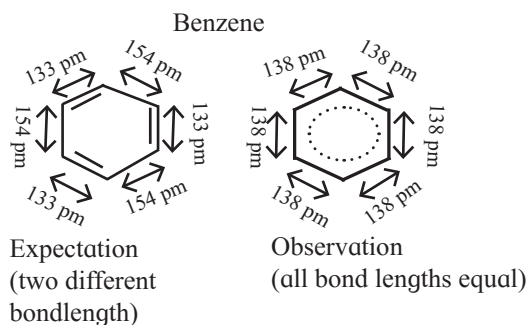

Fig 14.10 Structure of Benzene



Can you recall?

- Write down two Lewis structures for ozone. (Refer to chapter 5)
- How are these two Lewis structures related to each other ?
- What are these two Lewis structures called ?

When Lewis structure of a compound has two or more multiple bonds alternating with single bonds, it is called a **conjugated system of π bonds**. In such a system or in species having an atom carrying p orbital attached to a multiple bond, **resonance theory** is applicable.

We understand the following points from the resonance theory :

- (i) The π electrons in conjugated system of π bonds are not localized to a particular π bond.

- (ii) For a compound having a conjugated system of π bonds (or similar other systems) two or more Lewis structures are written by showing movement of π electrons (that is delocalization of π electrons) using curved arrows.

The Lewis structures so generated are linked by **double headed arrow** and are called **resonance structures** or **contributing structures** or **cononical structures** of the species. Thus, two resonance structures can be drawn for benzene by delocalizing or shifting the π electrons :

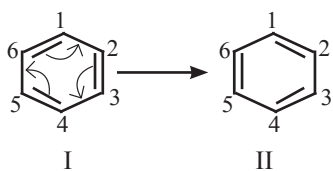

- (iii) The positions of the carbon atoms in the conjugated system of π bonds remain unchanged, but the positions of π electrons are different in different resonance structures. For example, in the resonance structure I of benzene there is a single bond between C^1 and C^2 while in the resonance structure II there is a double bond between C^1 and C^2 .
- (iv) Any resonance structure is hypothetical and does not by itself represent any real molecule and can explain all the properties of the compound. The real molecule has, however, character of all the resonance structures those can be written. The real or actual molecule is said to be the **resonance hybrid** of all the resonance structures. For example an actual benzene molecule is the resonance hybrid of structures I and II and exhibit character of both these structures. Its approximate representation can be shown as a dotted circle inscribed in a regular hexagon. Thus each carbon carbon bond in benzene has single as well as double bond character and the ring has a regular hexagonal shape.



Resonance hybrid of structures I and II

- (v) Hypothetical energy of an individual resonance structure can be calculated using bond energy values. The energy of actual molecule is, however, lower than that of any one of the resonance structures. In other words, **resonance hybrid is more stable** than any of the resonance structures. The difference in the actual energy and the lowest calculated energy of a resonance structure is called **resonance stabilization energy** or just **resonance energy**. Thus, resonance leads to stabilization of the actual molecule.

Problem 14.8 : Identify the species that contains a conjugated system of π bonds. Explain your answer.

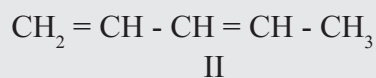
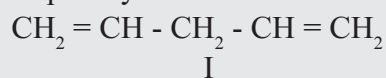

Solution : I Does not contain conjugated system of π bonds, as the two $C = C$ double bonds are separated by two $C - C$ single bonds.

II Contains a conjugated system of π bonds, as the two $C = C$ double bonds are separated by only one $C - C$ single bond.

Rules to be followed for writing resonance structure :

- Resonance structures can be written only when all the atoms involved in the π conjugated system lie in the same plane.
- All the resonance structures must have the same number of unpaired electrons.
- Resonance structures contribute to the resonance hybrid in accordance to their energy or stability. More stable (having low energy) resonance structures contribute to largely and thus are important.

Thus, between the compared resonance structures, that resonance structure is more stable and therefore important which has (a) more number of covalent bonds, (b) more number of atoms with complete octet or duplet, (c) less separation, if any, of opposite charges, (d) negative charge, if any, on more electronegative atom and positive charge, if any, on more electropositive atom and (e) more dispersal of charge.

Problem 14.9 : Write resonance structures of $\text{H} - \text{COO}^-$ and comment on their relative stability.

Solution : First the detailed bond structure of $\text{H} - \text{COO}^-$ showing all the valence electron is drawn and then other resonance structures are generated using curved arrow to show movement of π -electrons. Two resonance structures are written for $\text{H} - \text{COO}^-$.

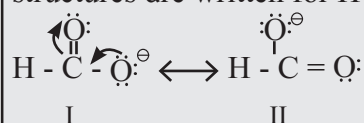

Both the resonance structures I and II are equivalent to each other, and therefore, are equally stable.

Problem 14.10 : Identify the species which has resonance stabilization. Justify your answer.

- (i) $\text{CH}_3 - \ddot{\text{O}} - \text{H}$ (ii) $\text{CH}_3 - \text{NO}_2$
(iii) buta - 1, 3 - diene

Solution :

(i) The bond structure shows that there is no π bond. Therefore no resonance and no resonance stabilization.

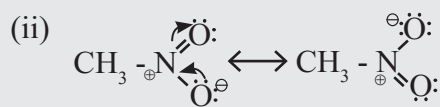

$\text{N} = \text{O}$ double bond is attached to 'O' which carries lone pair of electrons in a p orbital. Therefore resonance structures can be written and species is resonance stabilized.

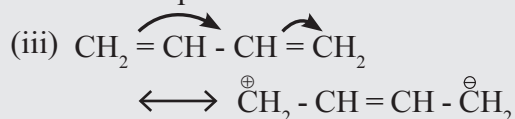

The Lewis structure shows two $\text{C} = \text{C}$ double bonds alternating with a $\text{C} - \text{C}$ single bond. Therefore resonance structures can be written as shown, and the species is resonance stabilized.



Remember

When all the resonance structures of a species are equivalent to each other, the species is highly resonance stabilized. For example, $\text{R} - \text{COO}^-$, CO_3^{2-}

Problem 14.11 : Write three resonance structures for $\text{CH}_3 - \text{CH} = \text{CH} - \text{CHO}$. Indicate their relative stabilities and explain.

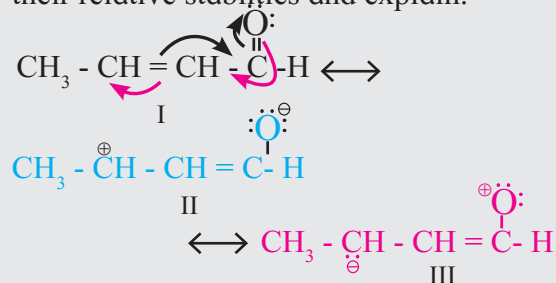

Stability order : $\text{I} > \text{II} > \text{III}$

I : Contains more number of covalent bonds, each carbon atom and oxygen atom has complete octet, and involves no separation of opposite charges. Therefore the most stable resonance structure.

II : Contains one covalent bond less than in I, one carbon (C^{\oplus}) has only 6 valence electrons, involves separation of opposite charges; the resonance structure II has -ve charge on more electronegative 'O' and +ve charge on more electropositive 'C'. It has intermediate stability.

III : Contains one covalent bond less than in I, oxygen has only 6 valence electrons, involves separation of opposite charge, has -ve charge on the more electropositive 'C' and +ve charge on more electronegative 'O'. All these factors are unfavourable for stability. Therefore it is the least stable.

14.6.6 Resonance Effect : The existence of resonance often results in developing polarity in a molecule. **The polarity produced in the molecule by the interaction between conjugated π bonds (or that between π bond and p orbital on attached atom) is called the resonance effect or mesomeric effect.** The effect is transmitted through a chain of conjugated π bonds. There are two types of resonance effects (or mesomeric effect) designated as positive resonance effect (+R or +M) and negative resonance effect (-R or -M). **Positive resonance effect or electron donating / releasing resonance effect (+ R effect) :** If the substituent group has a lone pair of electrons to donate to the attached π bond or conjugated system of π bonds, the effect is called +R effect. Group such as -OH, -OR, -O[⊖], -NHR, -halogen, etc. having lone pair of electrons show +R effect. The +R effect increases electron density at certain positions in a molecule. Figure 14.11 shows how the +R effect in aniline increases the electron density at ortho and para positions.

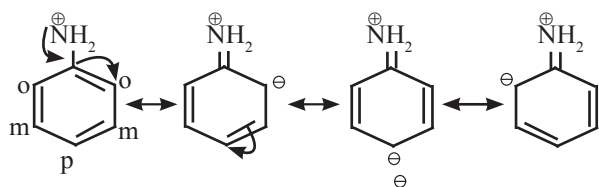

Fig. 14.11 : +R effect in aniline

Negative resonance effect or electron withdrawing resonance effect (-R effect) :

If the substituent group has a tendency to withdraw electrons from the attached π bond or conjugated system of π bonds towards itself, the effect is called -R effect. Group such as -COOH, -CHO, -CO-, -CN, -NO₂, -COOR, etc. show -R effect. The -R effect results in developing a positive polarity at certain positions in a molecule. Figure 14.12 shows how -R effect in nitrobenzene develops positive polarity at the ortho and para positions.

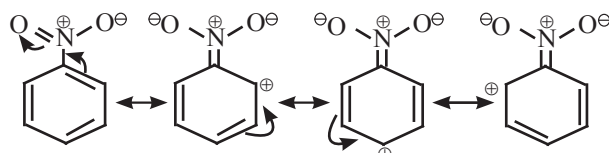
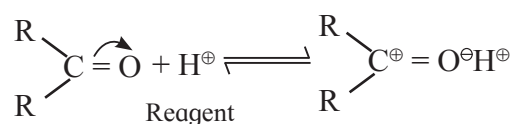

Fig. 14.12 : -R effect in aniline

14.6.7 Electromeric effect : This is a temporary electronic effect exhibited by multiple-bonded groups in the excited state in the presence of a reagent. When a reagent approaches a multiple bond, the electron pair gets completely shifted to one of the multiply bonded atoms, giving a charged separated structure. For example :



This effect is temporary and disappears when the reagent is removed from the reacting system.

14.6.8 Hyperconjugation :

Hyperconjugation is a permanent electronic effect explains stability of a carbocation, free radical or alkene. It is delocalization of σ (sigma) electrons of a C - H bond of an alkyl group directly attached to a carbon atom which is part of an unsaturated system or has an empty p- orbital or a p - orbital with an unpaired electron (see Fig. 14.13).

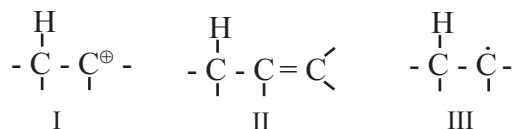

Fig. 14.13 Species stabilized by hyperconjugation

Let us consider ethyl cation (CH₃CH₂[⊕]). Here the positively charged carbon atom with an empty p -orbital has an adjacent methyl group, that is an α - (alpha) methyl group. One of the C-H bonds of this α methyl group is in allignment with the empty p-orbital. The σ electrons of this C-H bond or delocalized into the empty p -orbital and thereby stabilize the cation (see Fig. 14.14).

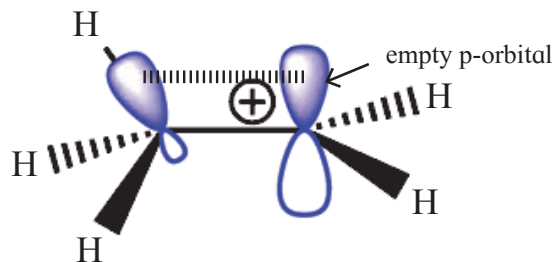
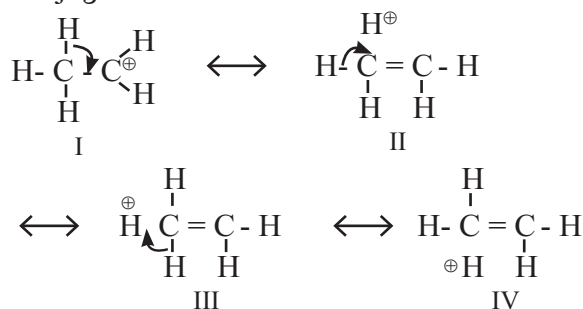
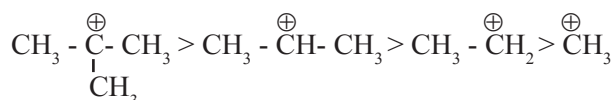

Fig. 14.14 Hyperconjugation in ethyl carbocation

Hyperconjugation is, thus a σ - π conjugation.



The contributing structures II, III and IV involving delocalization of σ electrons of C-H bond shows no covalent bond between carbon and one of the α -hydrogens. Hyperconjugation is, therefore, called '**no bond resonance**'. More the number of such α -hydrogens (that is, hydrogen on the α -carbon), more are the no bond resonance structures and more is the stability. The relative stability of carbocations, therefore decreases in the order :



Let us now look at propene which has a methyl group attached to $\text{C}=\text{C}$. Delocalization of electrons by hyperconjugation in propene can be depicted as shown.

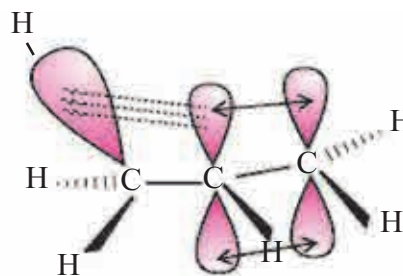
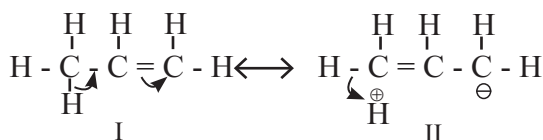

Fig. 14.15 : shows the orbital diagram of hyperconjugation in propene

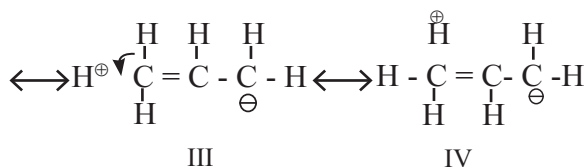

Figure 14.15 shows the orbital diagram of hyperconjugation in propene.

The effect of hyperconjugation is usually stronger than inductive effect.



Internet my friend

1. Basic principles of organic chemistry
<https://authors.library.caltech.edu/25034>
2. Collect information about Isomerism



Exercises

1. Answer the following :

A. Write condensed formulae and bond line formulae for the following structures.

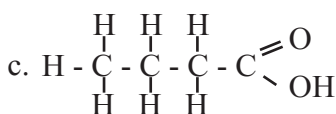
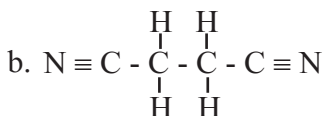
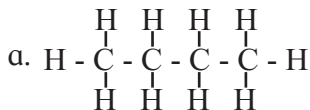

B. Write dash formulae for the following bond line formulae.

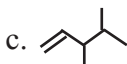
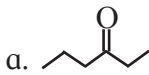

C. Write bond line formulae and condensed formulae for the following compounds

a. 3-methyloctane b. hept-2-ene

c. 2, 2, 4, 4- tetramethylpentane

d. octa-1,4-diene e. methoxyethane

D. Write the structural formulae for the following names and also write correct IUPAC names for them.

a. 5-ethyl-3-methylheptane

b. 2,4,5-trimethylhexane

c. 2,2,3-trimethylpentan-4-ol

E. Identify more favourable resonance structure from the following. Justify.

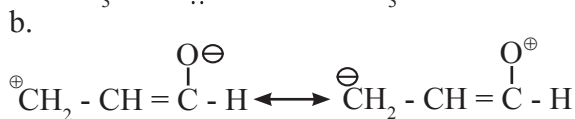
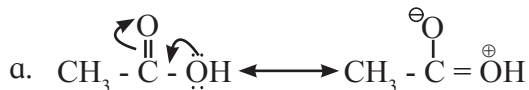

F. Find out all the functional groups present in the following polyfunctional compounds.

a. Dopamine a neurotransmitter that is deficient in Parkinson's disease.

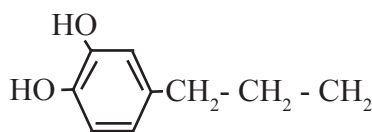

b. Thyroxine the principal thyroid hormone.

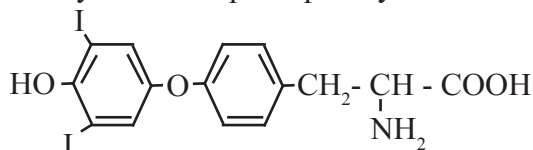

c. Penicillin G a naturally occurring antibiotic

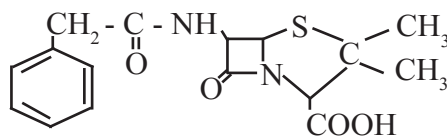

G. Find out the most stable species from the following. Justify.

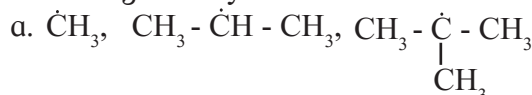

H. Identify the α - carbons in the following species and give the total number of α -hydrogen in each.



1. Identify primary, secondary, tertiary and quaternary carbon in the following compounds.

a.

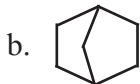
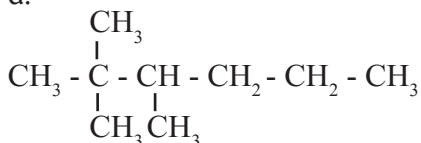

2. Match the pairs

Column 'A'

- Inductive effect
- Hyperconjugation
- Resonance effect

Column 'B'

- delocalisation of π electrons
- displacement of π electrons
- delocalisation of σ electrons
- displacement of σ electrons

3. What is meant by homologous series? Write the first four members of homologous series that begins with

- A. CH_3CHO B. $\text{H-C}\equiv\text{C-H}$

Also write down their general molecular formula.

4. Write IUPAC names of the following

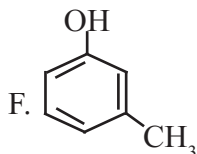
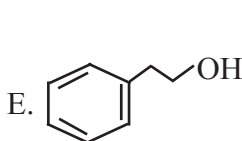
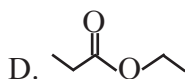
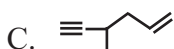
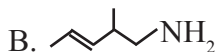
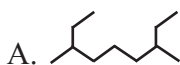

5 Find out the type of isomerism exhibited by the following pairs.

- A. $\text{CH}_3\text{-CH}_2\text{-NH-CH}_2\text{-CH}_3$
and $\text{CH}_3\text{-NH-CH}_2\text{-CH}_2\text{-CH}_3$

- B. $\text{CH}_3\text{-}\underset{\text{OH}}{\text{CH}}\text{-CH}_2\text{-CH}_3$ and

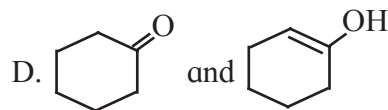
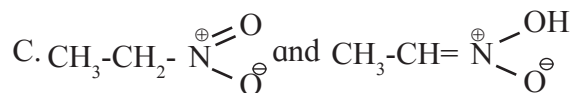
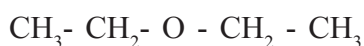

6. Draw resonance structures of the following :

- A. Phenol B. Benzaldehyde
C. Buta-1,3-diene D. Acetate ion

7. Distinguish :

- A. Inductive effect and resonance effect
B. Electrophile and nucleophile
C. Carbocation and carbanion
D. Homolysis and heterolysis

8. Write true or false. Correct the false statement

- A. Homolytic fission involves unsymmetrical breaking of a covalent bond.
B. Heterolytic fission results in the formation of free radicals.
C. Free radicals are negatively charged species
D. Aniline is heterocyclic compound.

9. Phytane is naturally occurring alkane produced by the alga spirogyra and is a constituent of petroleum. The IUPAC name for phytane is 2,6,10,14-tetramethylhexadecane. Write zig-zag formula for phytane. How many primary, secondary, tertiary and quaternary carbons are present in this molecule.

10. Observe the following structures and answer the questions given below.

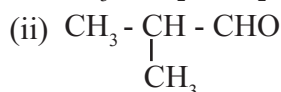
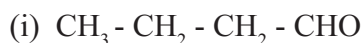

- What is the relation between (i) and (ii) ?
- Write IUPAC name of (ii).
- Draw the functional group isomer of (i).

11. Observe the following and answer the questions given below

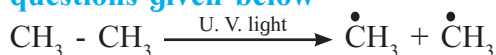

- Name the reactive intermediate produced
- Indicate the movement of electrons by suitable arrow to produce this intermediate
- Comment on stability of this intermediate produced.

12. An electronic displacement in a covalent bond is represented by following notation.



- Identify the effect
- Is the displacement of electrons in a covalent bond temporary or permanent.

13. Draw all the no-bond resonance structures of isopropyl carbocation.

14. A covalent bond in tert-butylbromide breaks in a suitable polar solvent to give ions.

- Name the anion produced by this breaking of a covalent bond.
- Indicate the type of bond breaking in this case
- Comment on geometry of the cation formed by such bond cleavage.

15. Choose correct options

- Which of the following statements are true with respect to electronic displacement in covalent bond ?
 - Inductive effect operates through π bond
 - Resonance effect operates through σ bond
 - Inductive effect operates through σ bond
 - Resonance effect operates through π bond
 - a. and b
 - a and c
 - c and d
 - b and c
- Hyperconjugation involves overlap of orbitals
 - $\sigma - \sigma$
 - $\sigma - p$
 - $p - p$
 - $\pi - \pi$

C. Which type of isomerism is possible in $\text{CH}_3\text{CHCHCH}_3$?

- Position
- Chain
- Geometrical
- Tautomerism

D. The correct IUPAC name of the compound

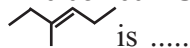

- hept-3-ene
- 2-ethylpent-2-ene
- hex-3-ene
- 3-methylpent-3-ene

E. The geometry of a carbocation is

- linear
- planar
- tetrahedral
- octahedral

F. The homologous series of alcohols has general molecular formula

- $\text{C}_n\text{H}_{2n+1}\text{OH}$
- $\text{C}_n\text{H}_{2n+2}\text{OH}$
- $\text{C}_n\text{H}_{2n-2}\text{OH}$
- $\text{C}_n\text{H}_{2n}\text{OH}$

G. The delocalization of electrons due to overlap between p-orbital and sigma bond is called

- Inductive effect
- Electronic effect
- Hyperconjugation
- Resonance



Activity :

Construct models of different types of organic compounds. Explain each compound in class.

15. Hydrocarbons



Can you recall?

1. What are hydrocarbons?
2. Write structural formulae of the following compounds : propane, ethyne, cyclobutane, ethene, benzene.

The compounds which contains carbon and hydrogen as the only elements are called hydrocarbons.

Hydrocarbons can be **open chain** or **cyclic**. In accordance with presence or absence of carbon-carbon multiple bond ($C=C$ and/ or $C \equiv C$) the hydrocarbons are called **unsaturated** or **saturated**. Cyclic unsaturated hydrocarbon can be either **aromatic** or **nonaromatic** (Fig. 15.1).

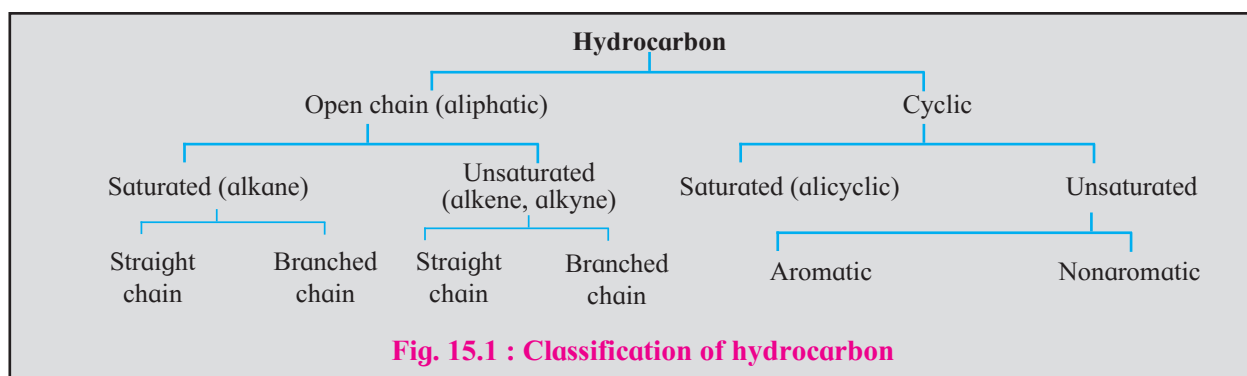

Do you know ?

Why are alkanes called paraffins? Alkanes contain only carbon-carbon and carbon-hydrogen single covalent bonds. They are chemically less reactive and do not have much affinity for other chemicals. Hence they are called paraffins.

15.1 Alkanes

Alkanes are aliphatic saturated hydrocarbons containing carbon-carbon and carbon-hydrogen single covalent bonds. You have learnt in Chapter 14 that alkanes have general formula C_nH_{2n+2} where 'n' stands for the number of carbon atoms in the alkane molecule.

15.1.1 Isomerism in alkanes

Alkanes with more than three carbon atoms generally exhibit, structural isomerism and in particular, the chain isomerism (refer to section 14.5.1)



Internet my friend

Collect information about Hydrocarbon

Figure 15.2 shows IUPAC and common names of structural isomers of C_4H_{10} and C_5H_{12} .

The number of possible structural isomers increase rapidly with the number of carbon atoms. (See the Table 15.1).

Table 15.1 : Alkanes and isomer number

Number of Carbon	Alkane	Number of isomers
1	Methane	No structural isomer
2	Ethane	No structural isomer
3	Propane	No structural isomer
4	Butane	Two
5	Pentane	Three
6	Hexane	Five

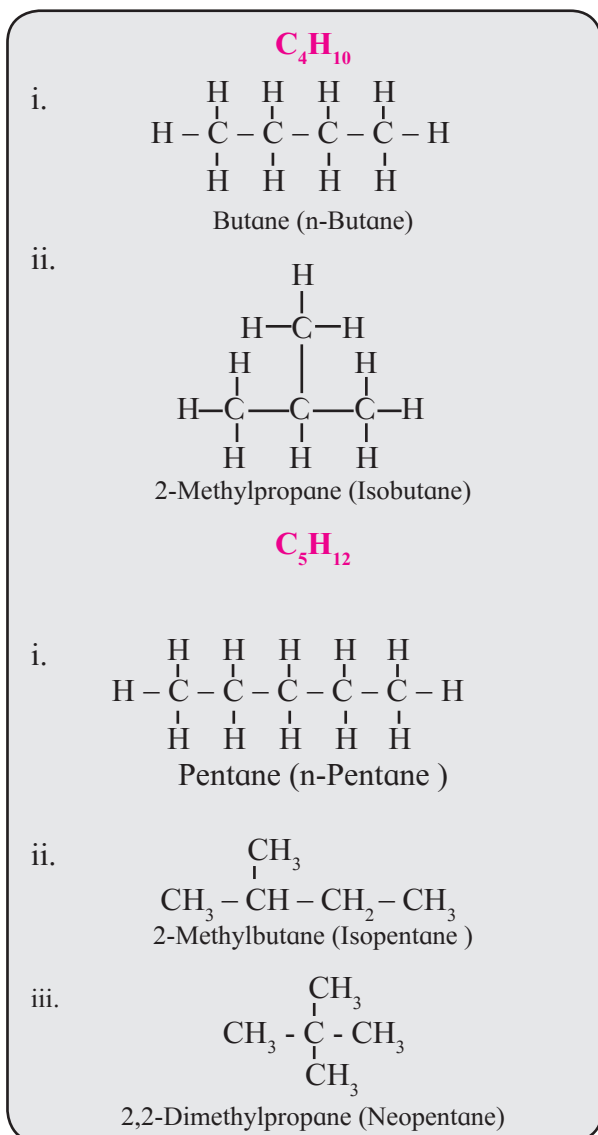

Fig. 15.2 : Structural isomers of butane and pentane

15.1.2 Conformation in alkanes : Alkanes have only single bonded atoms. You have learnt that a single covalent bond is formed by coaxial overlap of orbital and is called sigma (σ) bond (Refer to Chapter 5). As a direct consequence of coaxial overlap of orbitals, a sigma bond is cylindrically symmetrical and the extent of orbital overlap is unaffected by rotation about the single bond and therefore C-C bonds undergo rotation. The atoms bonded to one carbon of a C-C single bond change their relative position with reference to the atoms on the other carbon of that bond on rotation of that C-C single bond.



Use your brain power

1. Write the structures of all the chain isomers of the saturated hydrocarbon containing six carbon atoms.
2. Write IUPAC names of all the above structures

The resulting arrangements of the atoms in space about the C - C single bond are called conformations. Innumerable **conformations** result on complete rotation of a C - C single bond through 360°.

In chapter 14 you have learnt about **isomerism**. The phenomenon of existence of conformation is a type of **stereoisomerism**. In conformational isomerism the conformations (or **conformational isomers**) interconvert by rotation about a C - C single bond. Out of infinite **conformations of ethane** molecule two are extreme and called **staggered and eclipsed** conformation. They are represented by **Sawhorse formula** and **Newman projection formula** as shown in Fig. 15.3. Conformational isomerism in other alkanes is more complex.

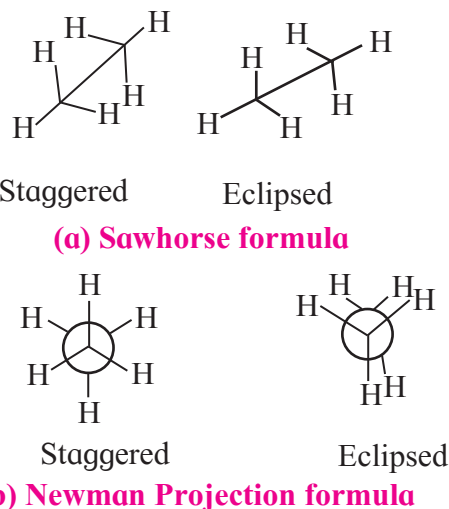

Fig. 15.3 : Representation of staggered and eclipsed conformation of ethanes



Do you know ?

Preparation of Grignard reagent is an exothermic reaction. Hence no heating is required. In this reaction :

- Magnesium metal gradually disappears.
- Magnesium atoms gets bonded to the same carbon that previously held halogen.
- Alkyl group remains as it is or intact during the preparation grignard reagent.

15.1.4 Physical properties of alkanes

i. Polarity : The electronegativity of carbon and hydrogen is nearly the same. C-H and C-C bonds are non-polar covalent bonds and alkanes are, thus, nonpolar. The forces which hold non-polar molecules together are the van der Waals forces. Those are usually weak. Larger the surface area of molecules, stronger are such intermolecular van der Waals forces.

The intermolecular forces are relatively stronger in straight chain alkanes than in branched alkanes (See Fig. 15.4).

Therefore straight chain alkanes have higher melting and boiling points.

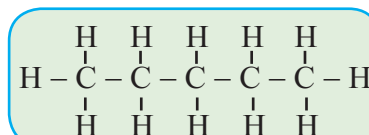

large surface area

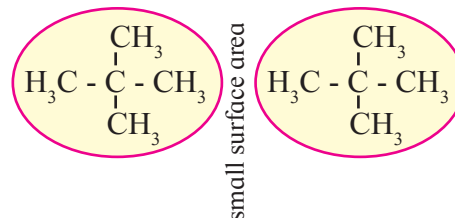
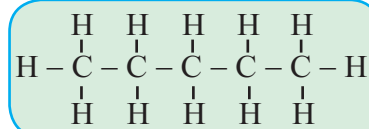

Fig. 15.4 : Relative surface area of straight chain and branched alkanes

Branched alkanes have lower melting and boiling points. Intermolecular forces are overcome partly during melting process and completely during boiling process. Table 15.2 shows the melting and boiling points of some alkanes. Alkanes are colourless and odourless. At room temperature, the first four alkanes are gases, next alkanes having 5 to 17 carbons are liquids and carbons 18 onwards are solids.



Use your brain power

Why are alkanes insoluble in water and readily soluble in organic solvents like chloroform or ether ?

Table 15.2 : Melting and Boiling points in alkanes

Molecular formula	Name	Molecular mass/u	b.p. (K)	m.p. (K)
CH ₄	Methane	16	111.0	90.5
C ₂ H ₆	Ethane	30	184.4	101.0
C ₃ H ₈	Propane	44	230.9	85.3
C ₄ H ₁₀	Butane	58	272.4	134.6
C ₄ H ₁₀	2-Methylpropane	58	261.0	114.7
C ₅ H ₁₂	Pentane	72	309.1	143.3
C ₅ H ₁₂	2-Methylbutane	72	300.9	113.1
C ₅ H ₁₂	2,2-Dimethylpropane	72	282.5	256.4
C ₆ H ₁₄	Hexane	86	341.9	178.5

15.1.5 Chemical properties of alkanes :

Alkanes are relatively unreactive towards acids, bases, oxidizing and reducing agents. They undergo the following reactions under specified conditions.

1. Halogenation of alkanes : The reactions in which an atom or group of atoms in a molecule is replaced by another atom or group of atoms are known as **substitution reactions**. Substitution of H atoms of alkanes by X (halogen, X= Cl, Br, I and F) atom is called **halogenation of alkanes**. Alkanes react with halogens in presence of UV light or diffused sunlight or at higher temperature (573 To 773 K) to give mixture of alkyl halides.

Chlorination of methane :

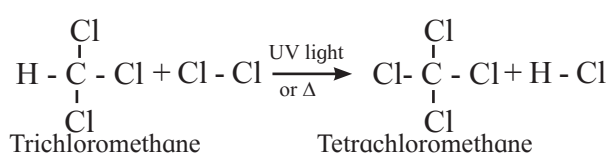
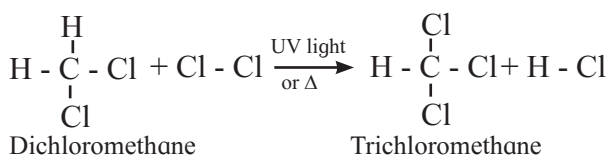
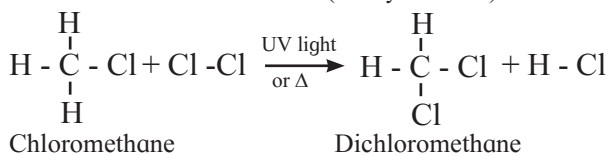
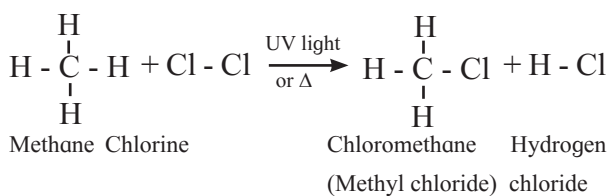

Tetrachloromethane is a major product when excess of chlorine is used. Chloromethane is obtained as major product when excess of methane is employed. The reactivity of halogens toward alkanes follows the order

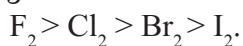

The ease of replacement of hydrogen atoms from the carbon is in the order of



For example,

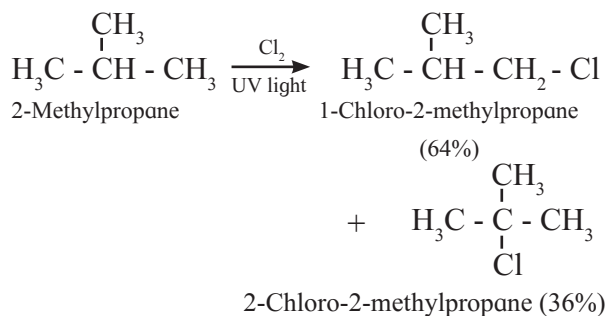
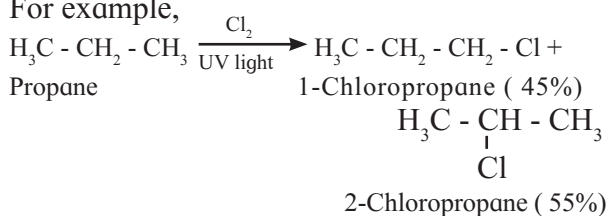

Bromination gives corresponding bromides, but in different proportions. For example,

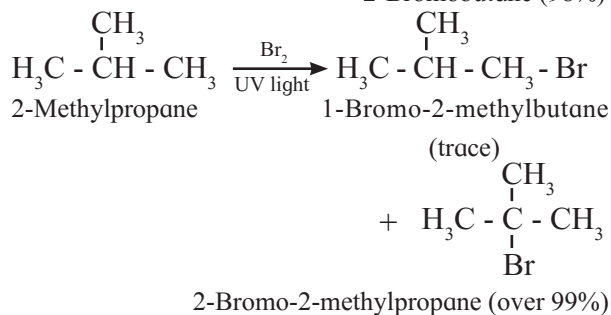
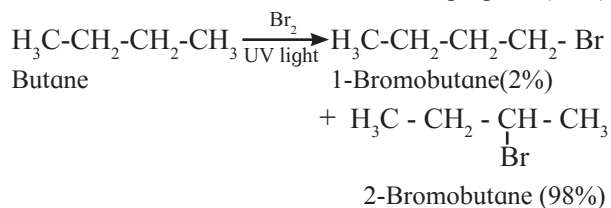
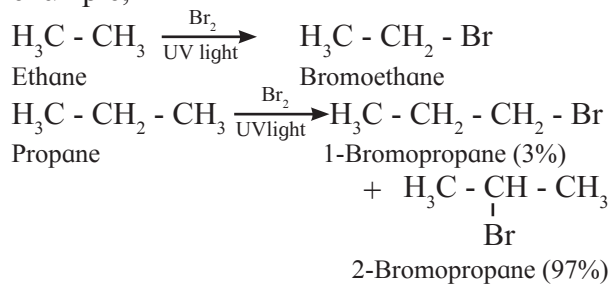

In bromination, there is high degree of selectivity as to which hydrogen atoms are replaced. Halogenation of alkanes follows the free radical mechanism. Homolysis of halogen molecule (X_2) generates halogen atoms i.e., halogen free radicals. The mechanism of the first step of chlorination of methane is shown below :

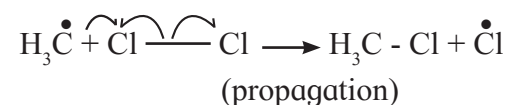
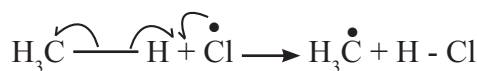
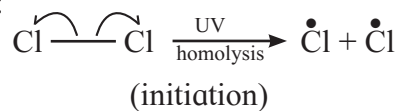



Remember

- Depending upon which hydrogen atom is replaced, a number of isomeric products can be formed from alkane. For example, n-Butane and isobutane yield two isomers each.
- Halogenation of an alkane yields a mixture of all possible isomeric products, indicating all the hydrogen atoms are susceptible to substitution.

2. Combustion : Alkanes on heating in the presence of air or dioxygen are completely oxidized to carbon dioxide and water with the evolution of a large amount of heat. That is why alkanes are good fuels.

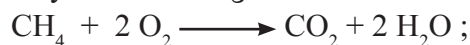

Methane

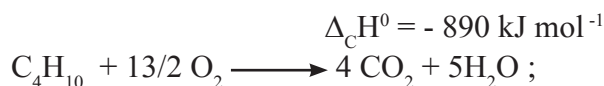

Butane

$$\Delta_c H^0 = -2875.84 \text{ kJ mol}^{-1}$$

A representative combustion equation for alkane is

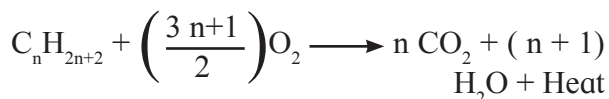

Can you recall?

What is the product which is poisonous and causes air pollution formed by incomplete combustion of alkane ?

3. Pyrolysis : Alkanes on heating at higher temperature in absence of air decompose to lower alkanes, alkenes and hydrogen etc. This is known as **pyrolysis or cracking**.

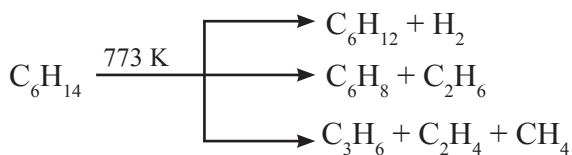

4. Reforming : Straight chain alkanes containing 6 to 10 carbon atoms are converted to benzene and its homologues on heating under 10 to 20 atm pressure at about 773 K

in the presence of V_2O_5 , Cr_2O_3 , Mo_2O_3 etc. supported over alumina. The reaction involves simultaneous dehydrogenation and cyclization. This reaction is known as **aromatization or reforming**.

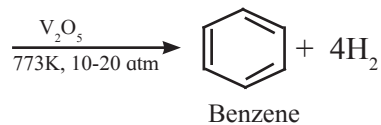
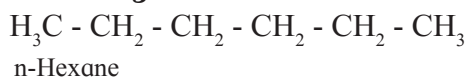

This process is used in refineries to produce high quality gasoline (the fuel used in automobiles).



Use your brain power

Name the alkane from which methyl benzene is obtained by reforming?

Collect the information of CNG and LPG with reference to the constituents and the advantages of CNG over LPG.

15.1.6 Uses of alkanes :

- First four alkanes are used as a fuel mainly for heating and cooking purpose. for example, LPG and CNG.
- CNG, petrol, diesel are used as fuels for automobiles.
- Lower liquid alkanes are used as solvent.
- Alkanes with more than 35 C atoms (tar) are used for road surfacing.
- Waxes are high molecular weight alkanes. They are used as lubricants. They are also used for the preparation of candles and carbon black that is used in manufacture of printing ink, shoe polish, etc.



Can you recall?

- What are alkenes?
- Calculate the number of sigma (σ) and pi (π) bonds in 2-Methylpropene ?
- Write structural formula of pent-2-ene.

15.2 Alkenes : Alkenes are unsaturated hydrocarbons containing a least one carbon-carbon double bond. Alkenes with one carbon-carbon double bond, contain two hydrogen atoms less than corresponding alkanes. They have general formula C_nH_{2n} , where $n = 2, 3, 4, \dots$ etc. You have also learnt about the IUPAC names of alkenes in Chapter 14.



Do you know ?

- Alkenes are also known as olefins, because the first member ethylene or ethene reacts with chlorine to form oily substance.
- The aliphatic unsaturated hydrocarbon containing two or three carbon-carbon double bonds are called alkadienes and alkatrienes, respectively. for example,

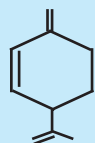
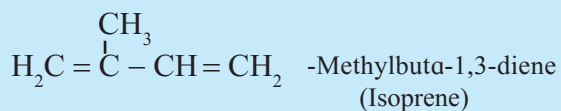

β -Phellandrene (oil of eucalyptus)

15.2.1 Isomerism in alkenes : Alkenes with more than three carbon atoms show both **structural isomerism** and **geometrical isomerism**.

i. Structural isomerism : Alkenes with molecular formula C_4H_8 is butene. The structural formulae for C_4H_8 can be drawn in three different ways :

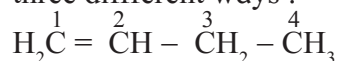

(I) But-1-ene (Chain of 4 carbon atoms)

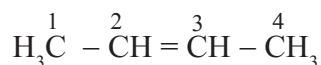

(II) But-2-ene (Chain of 4 carbon atoms)

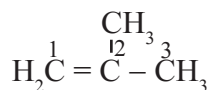

(III) 2-Methylprop-1-ene (Chain of 3 carbon atoms)

Structure I and III along with II and III are the examples of chain isomerism. They differ in carbon chain length. Structure I and II are the examples of position isomerism because they differ in the position of double bond in the same carbon chain.

ii. Geometrical isomerism

The isomerism which arises due to the difference in spatial arrangement of atoms or groups about doubly bonded carbon ($C=C$) atoms is called *geometrical isomerism*. If the two atoms or groups bonded to each end of the $C=C$ double bond are different, then molecule can be represented by two different special arrangements of the groups as follows :

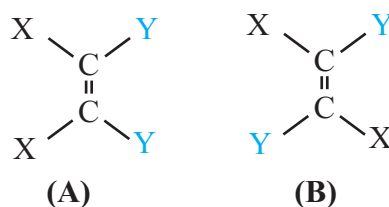

In structure (A), two identical atoms or groups lie on the same side of the double bond. **The geometrical isomer in which two identical or similar atoms or groups lie on the same side of the double bond is called *cis-isomer*.**

In structure (B), two identical atoms or groups lie on the opposite side of the double bond. **The geometrical isomer in which two identical or similar atoms or groups lie on the opposite side of the double bond is called *trans-isomer*.** Due to different arrangement of atoms or groups in space, these isomers differ in their physical properties like melting point, boiling point, solubility etc. Geometrical or cis-trans isomers of but-2-ene are represented as :

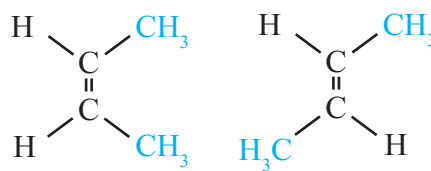



Do you know ?

1. No terminal alkenes i.e. those with $C=CH_2$ unit can exist as cis- and trans-isomers.
2. No 1,1-disubstituted alkenes i.e. those with $C=CR_2$ unit can exist as cis- and trans-isomers.
3. Alkenes with general formulae $RCH=CHR$, $R_1R_2C=CR_1R_2$, $R_1CH=CR_1R_2$, $R_1CH=CR_2R_3$, $R_1CH=CHR_2$ and $R_1R_2C=CR_3R_4$ exhibit cis-trans isomerism.

15.2 Preparation of alkenes

a. Industrial sources : The most important alkenes for chemical industry are ethene, propene and buta-1,3-diene. Alkenes containing upto four carbon atoms can be obtained in pure form from the petroleum products. Ethene is produced from natural gas and crude oil by cracking.

b. Methods of preparation of alkenes

(I) Elimination reactions : (1,2 -elimination)

The reactions in which two atoms or groups are eliminated or removed from adjacent carbon atoms are called **1,2 - elimination reactions**.

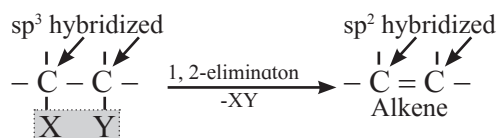

Remember

1. The carbon - carbon double bond can be generated from a carbon -carbon single bond by elimination reaction.
2. During elimination reaction sp^3 carbon atom changes to sp^2 carbon atom.

Some elimination reactions useful to prepare alkenes are described below.

i. Dehydrohalogenation of alkyl halides

Dehydrohalogenation means removal of hydrogen (H) atom and halogen (X) atom from adjacent carbon atoms. The carbon carrying X is called α -carbon atom.

The hydrogen atom from adjacent carbon called β -carbon atom, is removed and the reaction is known as β -elimination.

Dehydrohalogenation suffers from the disadvantage that -H can be eliminated from the carbon on either side of the α -carbon bearing the -X. When an alkyl halide is boiled with a hot concentrated alcoholic solution of a strong base like KOH or NaOH, alkene is formed with removal of water molecule.

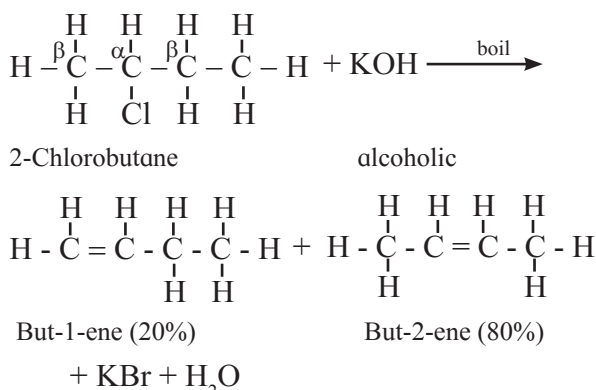
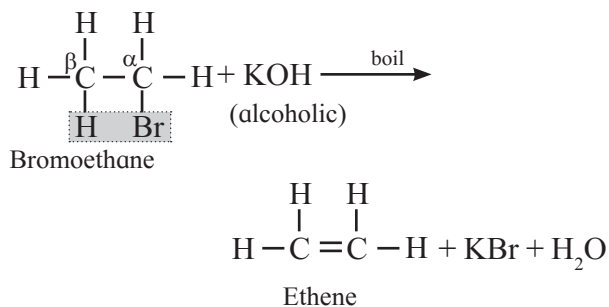

In dehydrohalogenation of 2-Chlorobutane, but-2-ene (disubstituted alkene) is the preferred product because it is formed faster than but-1-ene (monosubstituted alkene). This is in accordance with Saytzeff rule.

Saytzeff rule : *In dehydrohalogenation the preferred product is the alkene that has the greater number of alkyl groups attached to doubly bonded carbon atoms.*

The ease of dehydrohalogenation of alkyl halides accordingly is in the order $3^0 > 2^0 > 1^0$

The ease of formation of alkenes :

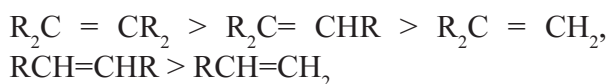

The stability of alkenes :

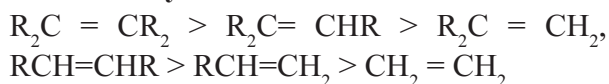



Can you recall?

- What are alcohols ?
- What is a dehydration of reaction?
- What is a catalyst ?

ii. Dehydration of alcohols : Alcohols on heating with sulphuric acid form alkenes with elimination of water molecule. The reaction is known as catalyzed dehydration of alcohols. The exact conditions of dehydration depend upon the alcohol.

Dehydration of alcohol is an example of β -elimination since OH group from α -carbon along with a H atom from β -carbon atom is removed.

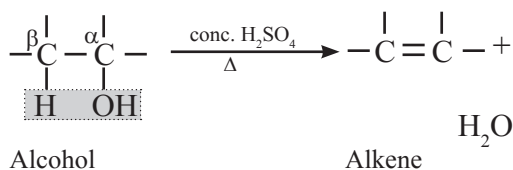

The ease of dehydration of alcohols is in the order $3^\circ > 2^\circ > 1^\circ$

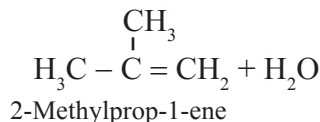
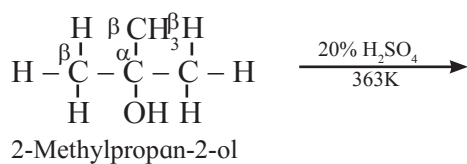
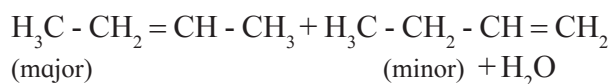
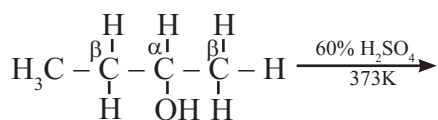
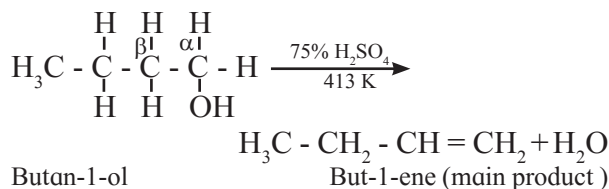

Can you tell?

1. Explain by writing a reaction, the main product formed on heating 2-methylbutan-2-ol with concentrated sulphuric acid.
2. Will the main product in the above reaction show geometrical isomerism?

iii. By dehalogenation of vicinal dihalides :

Removal of two halogen atoms from adjacent carbon atoms is called dehalogenation. The dihalides of alkane in which two halogen atoms are attached to adjacent carbon atoms are called vicinal dihalides. Vicinal dihalides on heating with zinc metal form an alkenes.

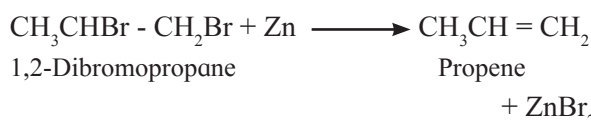
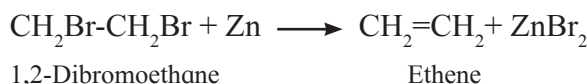
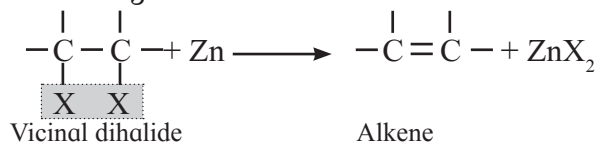

(II) Addition reactions : By partial reduction of alkynes (or controlled hydrogenation of alkynes) :

The $\text{C} \equiv \text{C}$ triple bond of alkynes can be partially reduced to a $\text{C} = \text{C}$ double bond with calculated quantity of dihydrogen in presence of Lindlar's catalyst (palladised charcoal deactivated partially with quinoline or sulfur compound). The *Cis* isomer is obtained by this method.

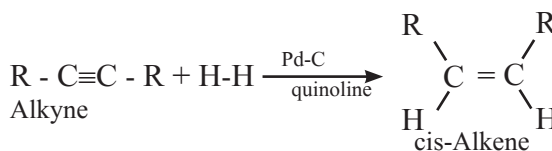

Trans alkene is obtained from alkyne on reduction with sodium in liquid ammonia.

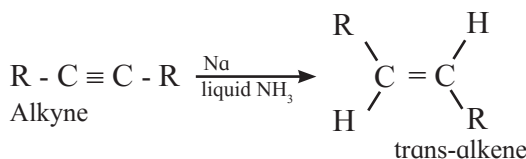

Table 15.3 : Melting point and boiling point of alkenes

Formula	Name	Molecular mass (u)	b.p. (K)	m.p. (K)
CH ₂ =CH ₂	Ethene	28	171	104
CH ₂ =CHCH ₃	Propene	42	225	88
CH ₂ =CHCH ₂ CH ₃	But-1-ene	56	267	--
CH ₂ =CH(CH ₂) ₂ CH ₃	Pent-1-ene	70	303	--
CH ₂ =CH(CH ₂) ₃ CH ₃	Hex-1-ene	84	337	135
cis CH ₃ CH=CHCH ₃	cis-But-2-ene	56	277	134
trans CH ₃ CH=CHCH ₃	trans-But-2-ene	56	274	167
CH ₂ =C(CH ₃) ₂	Isobutylene	56	266	132

15.2.3 Physical properties of alkenes : Alkenes are nonpolar or weakly polar compounds those are insoluble in water, and soluble in non-polar solvents like benzene, ether, chloroform. They are less dense than water. From Table 15.3, it is clear that the boiling point of alkane rises with increasing number of carbons. Branched alkenes have lower the boiling point than straight chain alkane. The boiling point of alkene is very nearly the same as that of alkane with the same carbon skeleton.

15.2.4 Chemical properties of alkenes :

Alkenes are more reactive than alkanes due to the presence of pi (π) electrons. They undergo electrophilic addition reactions. The different reactions of alkenes are given below:

1. Addition of dihydrogen/hydrogenation (see section 15.1.4).

2. Addition of halogens/halogenation.

Alkenes are converted into the corresponding vicinal dihalides by addition of halogens (X₂ = Cl₂ or Br₂) .

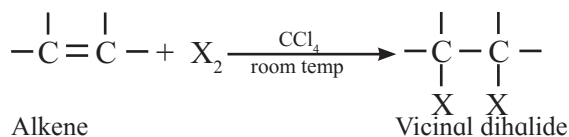

Iodine generally fails to react.

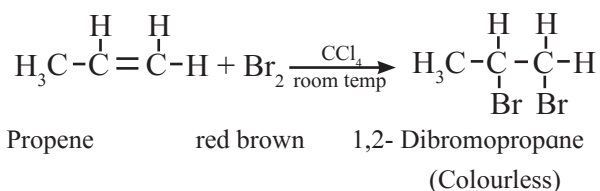
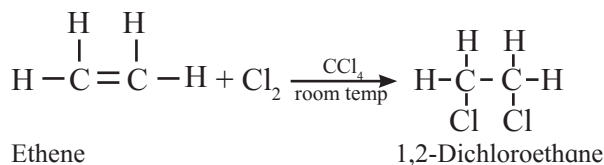

Addition of bromine is useful test for detection C = C in unknown compounds. Red brown colour of bromine rapidly disappears in carbontetrachloride solution if a C = C double bond is present in the compound.

3. Addition of hydrogen halides/ hydrohalogenation : Addition of hydrogen halides (HX) like hydrogen chloride, hydrogen bromide and hydrogen iodide converts alkene into the corresponding alkyl halides.

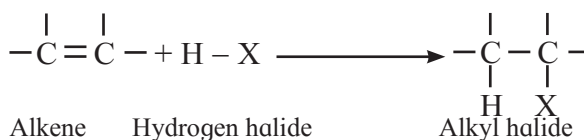

The order of reactivity of hydrogen halides is HI > HBr > HCl

Addition reaction of HBr to symmetrical alkenes : The addition of HBr to symmetrical alkenes yield only one product.

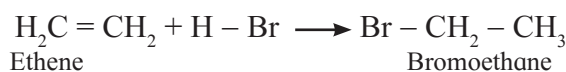
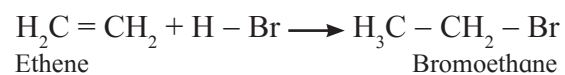

Addition reaction of HBr to unsymmetrical alkenes : Addition of HBr to unsymmetrical alkenes yield two isomeric products.

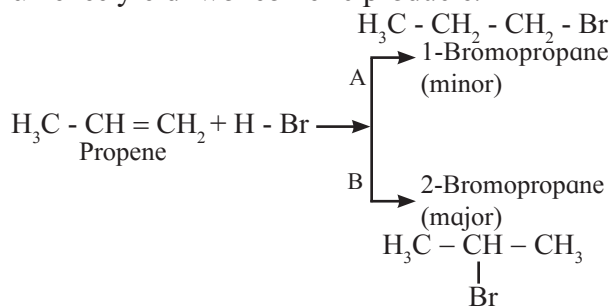

Experimentally it has been found that 2-Bromopropane is the major product. Russian chemist Markovnikov studied hydrohalogenation of a number of unsymmetrical alkenes and formulated a general rule (1869) as follows :

Markovnikov's rule : When an unsymmetrical reagent is added to unsymmetrical alkene, the negative part (X⁻) of the reagent gets attached to the carbon atom which carries less number of hydrogen atoms.

Anti-Markovnikov addition Or peroxide effect or Kharasch - Mayo effect : In 1933, M. S. Kharasch and F. R. Mayo discovered that the addition of HBr to unsymmetrical alkene in the presence of organic peroxide (R-O-O-R) takes place in the opposite orientation to that suggested by Markovnikov's rule.

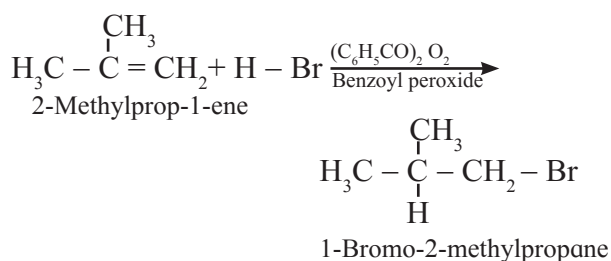
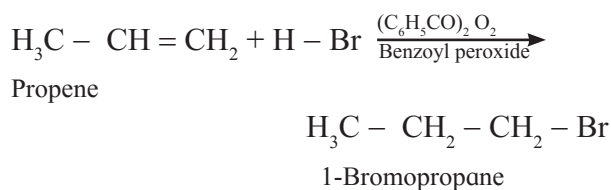

Internet my friend

http://www.britanica.com>science>hydrocarbon



Remember

1. The orientation of addition of HBr to unsymmetrical alkene is determined by the presence or absence of peroxide.
2. The peroxide has no effect upon the addition of HCl and HI.

4. Addition of sulphuric acid

Alkenes react with cold concentrated sulphuric acid to form alkyl hydrogen sulphate (ROSO₃H). The addition takes place according to **Markovnikov's rule**.

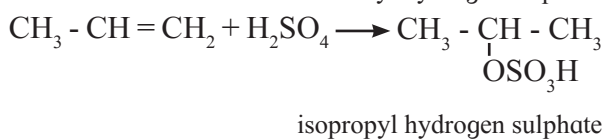
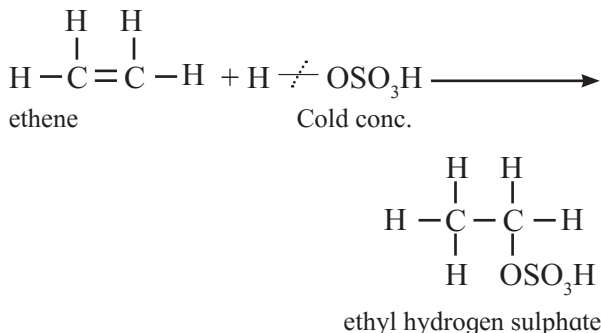
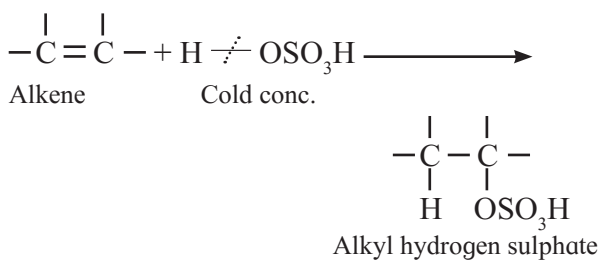

If alkyl hydrogen sulphate is diluted with water and heated, then an alcohol having the same alkyl group as the original alkyl hydrogen sulphate is obtained. This is an excellent method for the large scale manufacture of alcohols.

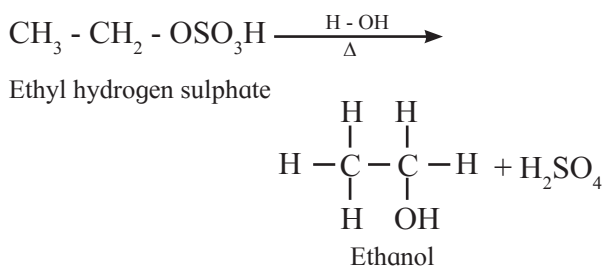

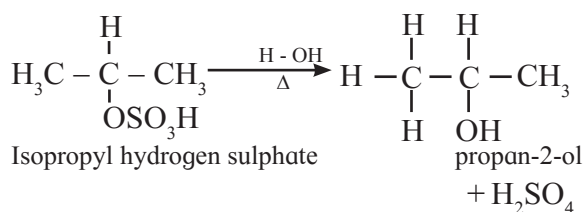

Reactive alkenes on adding water molecules in the presence of concentrated sulphuric acid, form alcohol. The addition of water takes place according to **Markovnikov's rule**. This reaction is known as hydration of alkenes.

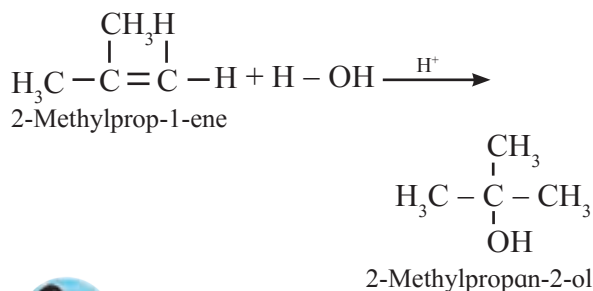

Can you tell?

Why Propan-1-ol and 2-Methylpropan-1-ol is not prepared by this method ?

5. Ozonolysis of alkenes : The C = C double bond gets cleaved on reaction with ozone followed by reduction. This overall process of formation of ozonide by reaction of ozone with alkene in the **first step** and then decomposing it to the carbonyl compounds by reduction in the **second step** is called ozonolysis.

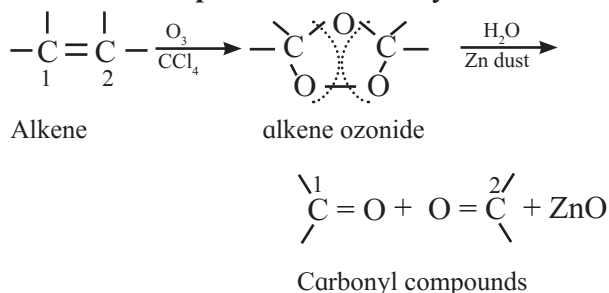

Ozone gas is passed into solution of the alkene in an inert solvent like carbon tetrachloride, unstable alkene ozonide is obtained. This is subsequently treated with water in the presence of a reducing agent zinc dust to form carbonyl compounds, namely, aldehydes and/or ketones .

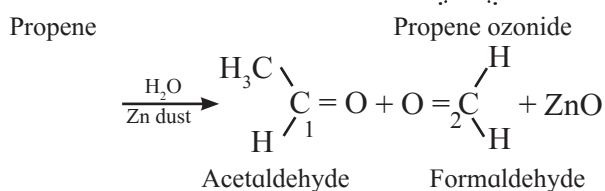
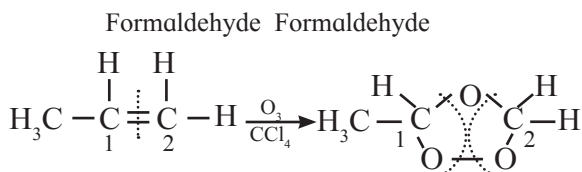
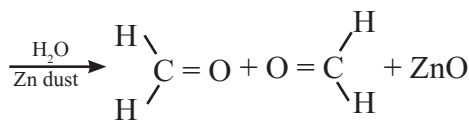
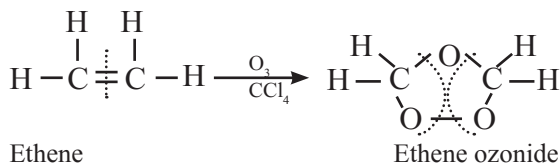

Remember

1. In the cleavage products a carbonyl group (C = O) is formed at each of the original doubly bonded carbon atoms.
2. Knowing the number and arrangement of carbon atoms in these aldehydes and ketones produced, we can identify the structure of original alkene.
3. The role of zinc dust is to prevent the formation of hydrogen peroxide which oxidizes aldehydes to corresponding acids.
4. This reaction is used to locate the position and determine the number of double bonds in alkenes.



Use your brain power

On ozonolysis an alkene forms the following carbonyl compounds. Draw the structure of unknown alkene from which these compounds are formed.



6. Hydroboration- oxidation of alkene

Alkenes with diborane in tetrahydrofuran (THF) solvent undergo hydroboration to form trialkylborane, which on oxidation with

alkaline peroxide forms primary alcohol. The overall reaction gives **Anti-Markovnikov's** product from unsymmetrical alkenes

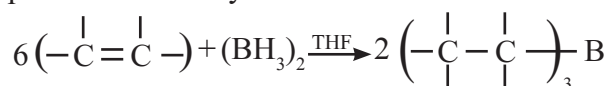

Alkene Diborane Trialkylborane

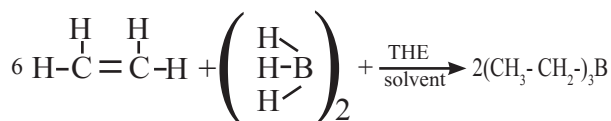
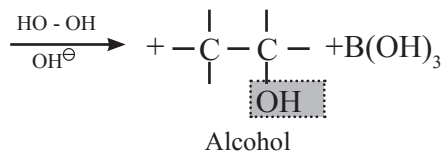

Ethene Diborane

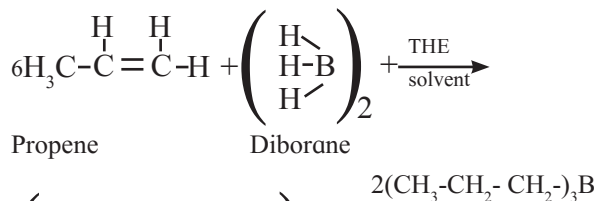
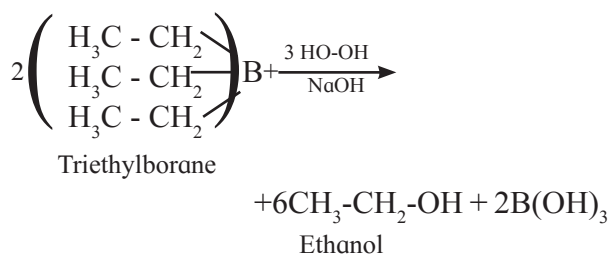

Propene

Diborane

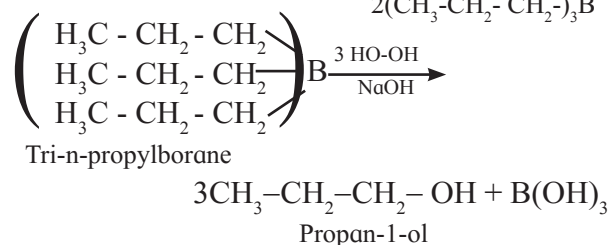

7. Polymerization : The process in which large number of small molecules join together and form very large molecules with repeating units is called **polymerization**. The compound having very large molecules made of large number repeating small units is called **polymer** and the simple compound forming the repeating units in the polymer is called **monomer**.

For example, ethene at high temperature and under high pressure interacts with oxygen, and undergoes polymerization giving high molecular weight polymer called polyethene.

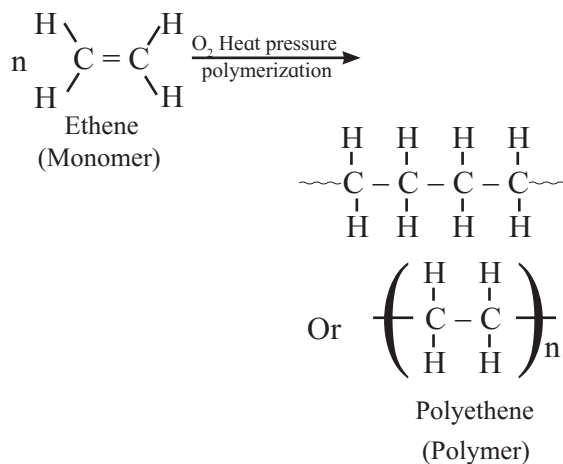

Here n represents the number of repeating units and is a large number.



Use your brain power

Write the structure of monomer from which each of the following polymers are obtained.

a. Teflon $-(\text{CF}_2-\text{CF}_2)-$

b. Polypropene $\left(\begin{array}{c} \text{CH}_3\text{H} \\ | \quad | \\ -\text{C}-\text{C}- \\ | \quad | \\ \text{H} \quad \text{Cl} \end{array} \right)_n$

c. Polyvinyl chloride $\left(\begin{array}{c} \text{H} \quad \text{H} \\ | \quad | \\ -\text{C}-\text{C}- \\ | \quad | \\ \text{H} \quad \text{Cl} \end{array} \right)_n$

8. Hydroxylation : Alkenes react with cold and dilute alkaline potassium permanganate to form glycols.

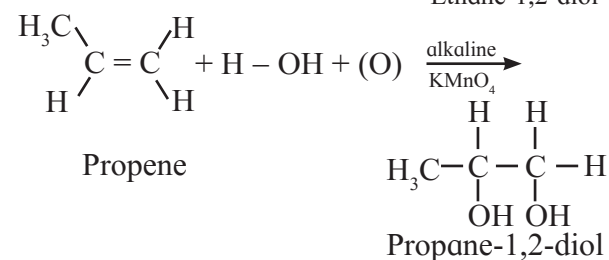
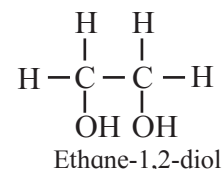
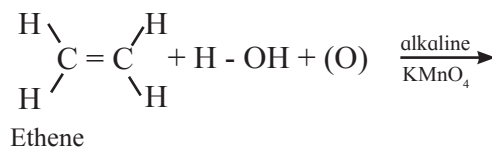

Hydroxylation of alkenes is the most important method for the synthesis of 1,2-diols (Glycols). During this reaction the purple colour of KMnO_4 disappears. Hence such reaction serves as qualitative test for detecting the presence of double bond in the compound under test. This is known as **Baeyer's test**.

9. Oxidation : Alkenes on oxidation with acidic KMnO_4 or acidic potassium dichromate form ketones and / or acids.

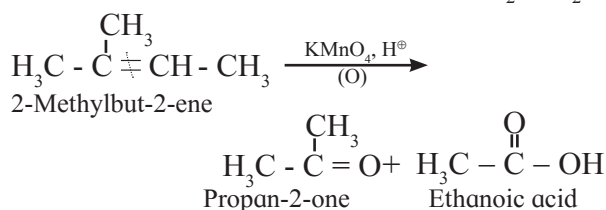
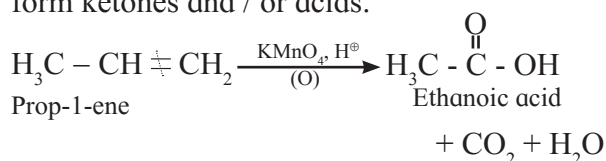

15.2.5 Uses of alkenes

- Alkenes, are used as starting materials for preparation of alkyl halides, alcohols, aldehydes, ketones, acids etc.
- Ethene and propene are used to manufacture polythene, polypropylene those find use in polyethene bags, toys, bottles, etc.
- Ethene is used for artificial ripening of fruits, such as mangoes.



Can you tell?

- What are aliphatic hydrocarbons?
- Compare the proportion of carbon and hydrogen atoms in ethane, ethene and ethyne. Which compound is most unsaturated with hydrogen?

15.3 Alkynes : Alkynes are aliphatic unsaturated hydrocarbons containing at least one $\text{C} \equiv \text{C}$. The number of hydrogen atoms is still less in alkynes as compared to alkenes. Their general formula is $\text{C}_n\text{H}_{2n-2}$. Table 15.4 shows names and formulae of lower alkynes.

15.3 Isomerism in alkynes : Alkynes show position isomerism which is a type of structural isomerism. For example 1-butyne and 2-butyne. 1-Alkynes are also called terminal alkynes.

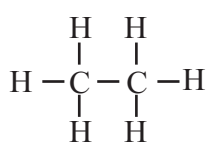

Ethane (C_2H_6)
(An alkane)

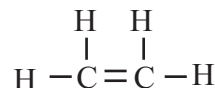

Ethene (C_2H_4)
(An alkene)

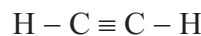

Ethyne (C_2H_2)
(An alkyne)

Table 15.4 : Lower alkynes

n	Molecular formula	Structural formula and Common name	IUPAC name
2	C_2H_2	$\text{H}-\text{C} \equiv \text{C}-\text{H}$ Acetylene	Ethyne
3	C_3H_4	$\text{CH}_3-\text{C} \equiv \text{CH}$ Methyl acetylene	Propyne
4	C_4H_6	$\text{CH}_3-\text{CH}_2-\text{C} \equiv \text{CH}$ Ethyl acetylene	But-1-yne
5	C_4H_6	$\text{C H}_3-\text{C} \equiv \text{C}-\text{C H}_3$ Dimethyl acetylene	But-2-yne



Do you know ?

- Simplest alkyne is ethyne which is known as acetylene.
- The carbon-carbon triple bond is a functional group.
- The aliphatic unsaturated hydrocarbons containing two or three carbon-carbon triple bonds are called alkadiynes and alkatriynes, respectively.
- Cicutoxin from poisonous plants 'water hemlock'.



15.3.2 Preparation of alkynes

a. Industrial sources :

i. Ethyne is industrially prepared by controlled, high temperature partial oxidation of methane.

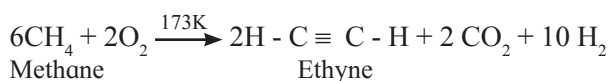

ii. From calcium carbide : Industrially the alkyne ethyne is prepared by reaction of calcium carbide with water.



b. Methods of preparation of alkynes

1. By dehydrohalogenation of vicinal dihalides : Removal of H and X from adjacent carbon atoms is called dehydrohalogenation. Vicinal dihalides react with alcoholic solution of potassium hydroxide to form alkenyl halide which on further treating with sodamide forms alkyne.

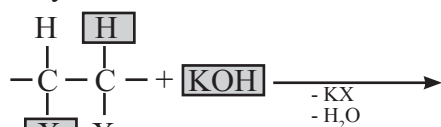

Vicinal dihalide (Alcoholic)

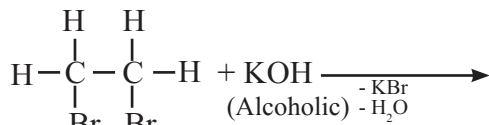
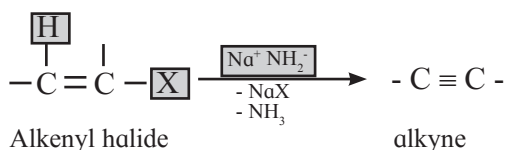

1,2-Dibromoethane

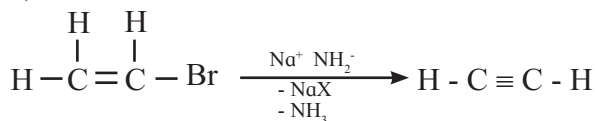

Bromoethene

Ethyne

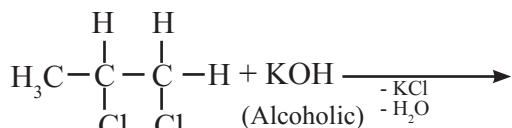

1,2-Dichloropropane

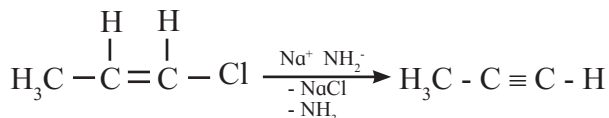

1-Chloropropane

Propyne



Can you tell?

Why sodamide is used in second step to remove HX from alkenyl halide in place of alcoholic KOH?

2. From terminal alkynes : Terminal alkynes are the compounds in which hydrogen atom is directly attached to triply bonded carbon atom.

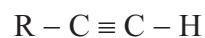
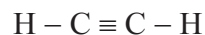

Such hydrogen atom shows appreciable acidity and can be given away as proton on reaction with sufficiently strong base.

In this method a smaller terminal alkyne first reacts with a very strong base like lithium amide to form metal acetylide (Lithium amide is easier to handle than sodamide).

Higher alkynes are obtained by reacting metal acetylides (alkyn-1-yl lithium) with primary alkyl halides.



Terminal alkyne Lithium amide Alkyn-1-yl lithium



Alkyn-1-yl lithium Primary alkyl halide Higher alkyne

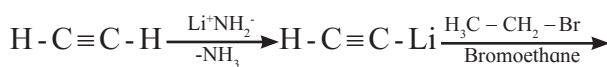

Ethyne

Ethynyllithium

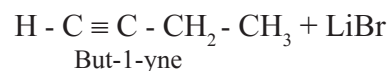

But-1-yne

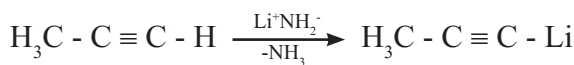

Propyne

Prop-1-yn-1-yl lithium

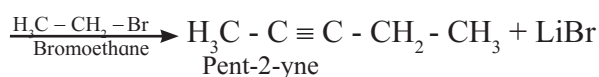

Pent-2-yne



Use your brain power

Convert : 1-Bromobutane to Hex-1-yne.

15.3.3 Physical properties of alkynes : The physical properties of alkynes are similar to those of alkanes and alkenes. They are less dense than water. They are insoluble in water and quite soluble in less polar organic solvents like ether, benzene, carbon tetrachloride. The melting points and boiling points of alkynes increase with an increase in molecular mass (Table 15.5).

Table 15.5 : Melting point and Boiling point of alkynes

Formula	Name	Molecular mass/u	Physical State	b.p.(K)	m.p.(K)
CH = CH	Ethyne	26	Gas	198	191
CH = CCH ₃	Propyne	40	Gas	250	171.5
CH = CCH ₂ CH ₃	But-1-yne	54	Gas	282	151
CH = C(CH ₂) ₂ CH ₃	Pent-1-yne	68	Liquid	313	175
CH = C(CH ₂) ₃ CH ₃	Hex-1-yne	82	Liquid	345	149

15.3.4 Chemical properties of alkynes :

1. Acidity of alkynes :

The hydrogen bonded to C ≡ C triple bond has acidic character. Lithium amide (LiNH₂) is very strong base and it reacts with terminal alkynes to form lithium acetylides with the liberation of hydrogen indicating acidic nature of terminal alkynes. Why is it so ? In terminal alkynes, hydrogen atom is directly attached to sp hybridized carbon atom. In sp hybrid orbital, the percentage of s-character is 50%. An electron in s-orbital is very close to the nucleus and is held tightly. The sp hybrid carbon atom in terminal alkynes is more electronegative than the sp² carbon in ethene or the sp³ carbon in ethane. Due to high electronegative character of carbon in terminal alkynes, hydrogen atom can be given away as proton (H⁺) to very strong base.

Examples

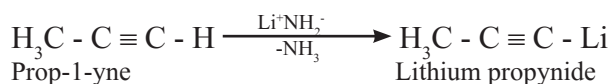
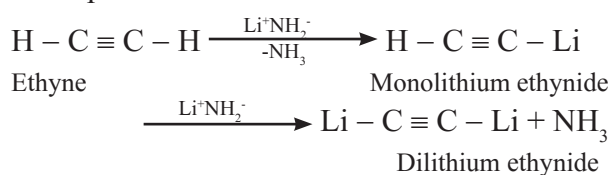

The relative acidity of alkanes, alkenes and alkynes follows the order

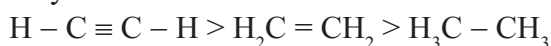

Can you tell?

Alkanes and alkenes do not react with lithium amide. Give reason.



Use your brain power

Arrange following hydrocarbons in the increasing order of acidic character. propane, propyne, propene.



Do you know ?

Acidic alkynes react with certain heavy metal ions like Ag⁺ and Cu⁺ and form insoluble acetylides. On addition of acidic alkyne to solution of AgNO₃ in alcohol form a precipitate which indicates that the hydrogen atom is attached to triply bonded carbon. This reaction is used to differentiate terminal alkynes and non-terminal alkynes.

2. Addition of dihydrogen (See method of preparation of alkenes from unsaturated hydrocarbons)

3. Addition of halogens

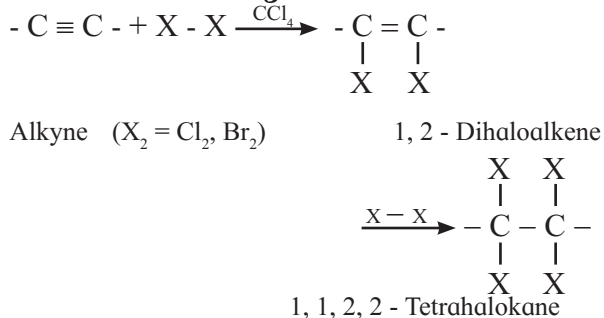

Ethyne reacts with bromine in inert solvent such as carbon tetrachloride to give tetrabromoethane.

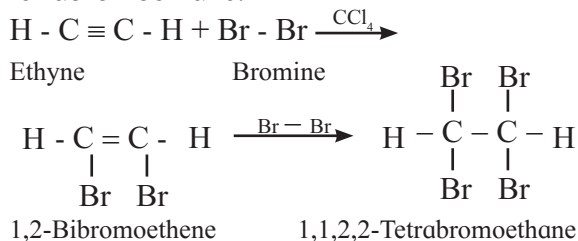

Red-brown colour of solution of bromine in carbon tetrachloride disappears. This test can be used to detect the presence of unsaturation in given compound.

4. Addition of hydrogen halides

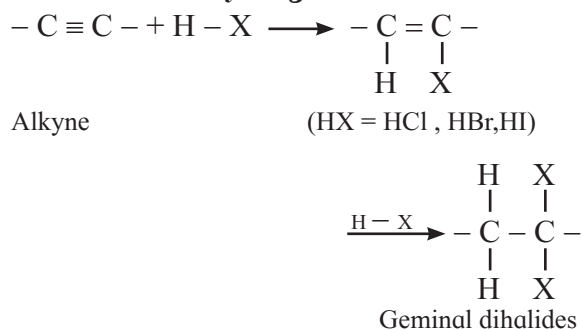

Hydrogen halides (HCl, HBr and HI) add to alkynes across carbon-carbon triple bond in two steps to form geminal dihalides (in which two halogen atoms are attached to the same carbon atom). The addition of HX in both the steps takes place according to **Markovnikov's rule**.

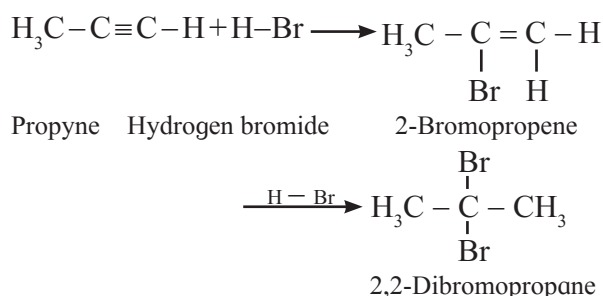
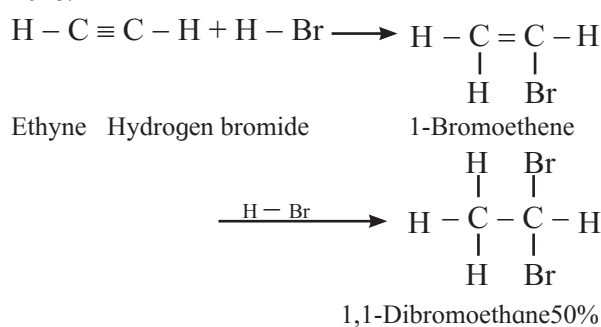

The order of reactivity of hydrogen halides is HI > HBr > HCl

5. Addition of water

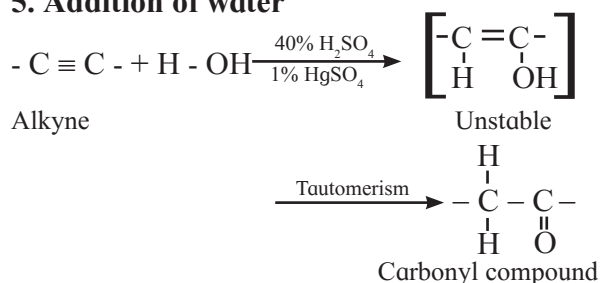

Alkynes react with water in presence of 40% sulphuric acid and 1% mercuric sulphate to form aldehydes or ketones i.e. carbonyl compounds.

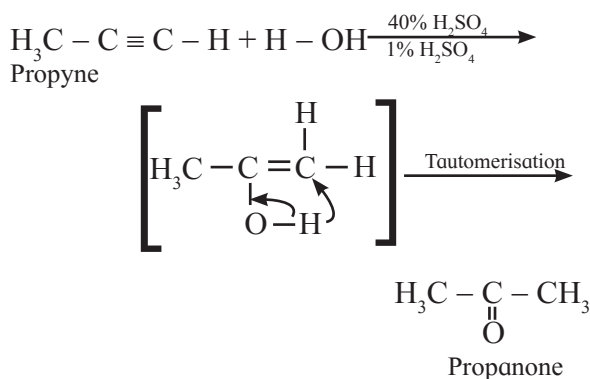
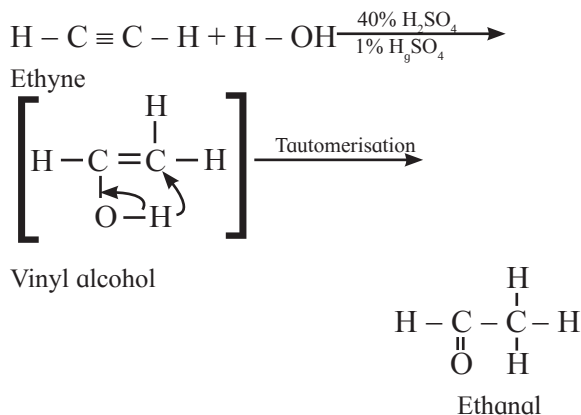

Use your brain power

Convert : 3-Methylbut-1-yne into 3-Methylbutan-2-one.

15.3.5 Uses of acetylene :

1. Ethyne (acetylene) is used in preparation of Ethanal (acetaldehyde), Propanone (acetone), ethanoic acid (acetic acid).
2. It is used in the manufacture of polymers, synthetic rubber, synthetic fibre, plastic etc.
3. For artificial ripening of fruits.
4. In oxy-acetylene (mixture of oxygen and acetylene) flame for welding and cutting of metals.

15.4 Aromatic Hydrocarbons :



Can you recall?

- What are aromatic hydrocarbons?
- What are benzenoid and non-benzenoid aromatics ?

Many organic compounds obtained from natural sources like resins, balsams, oil of wintergreen, etc. possessing pleasant fragrance (aroma = smell) are named as aromatic compounds. Aromatic hydrocarbons (also called arenes) contain only carbon and hydrogen. Benzene is the simplest aromatic compound.

Benzene and all compounds that have structures and chemical properties resembling benzene are classified as aromatic compounds.

Examples are :



Benzene

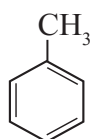

Methylbenzene

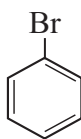

Bromobenzene

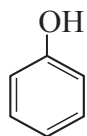

Phenol

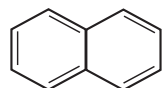

Naphthalene

15.4.1 Benzene : The molecular formula of benzene is C_6H_6 . Benzene is parent compound of most of the aromatic compounds.

Coal-tar and petroleum are the two large-scale sources of benzene (and aromatic compounds like toluene, phenol, naphthalene.).



Remember

1. Aromatic compounds contain planar cyclic rings.
2. Not all compounds those resemble benzene have pleasant odour (smell).

Anthracene

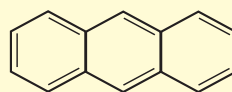

Anthracene is odourless.

3. Many compounds having pleasant odour do not resemble benzene.

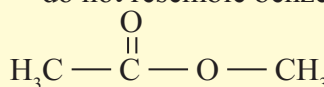

Methyl acetate

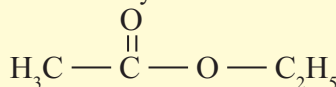

Ethyl acetate

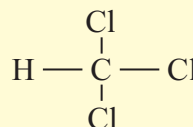

Trichloromethane or chloroform

It is a colourless liquid having characteristic odour. Its boiling point is 353K.

It was synthesized by Berthelot (1870) from acetylene. Benzene was originally called **phene** and hence C_6H_5 is called **phenyl group**.

Table 15.6 : Difference between aromatic and aliphatic compounds

Aromatic compounds	Aliphatic compounds
1. Aromatic compounds contain higher percentage of carbon.	1. Aliphatic compounds contain lower percentage of carbon.
2. They burn with sooty flame.	2. They burn with non-sooty flame.
3. They are cyclic compounds with alternate single and double bonds.	3. They are open chain compounds.
4. They are not attacked by normal oxidizing and reducing agents.	4. They are easily attacked by oxidizing and reducing agents.
5. They do not undergo addition reactions easily. They do not decolourise dilute alkaline aqueous $KMnO_4$ and Br_2 in CCl_4 , though double bonds appear in their structure.	5. Unsaturated aliphatic compounds undergo addition reactions easily. They decolourise dilute aqueous alkaline $KMnO_4$ and Br_2 in CCl_4 .
6. They prefer substitution reactions.	6. The saturated aliphatic compounds give substitution reactions.

15.4.2 Structure of benzene :

1. Molecular formula of benzene, C_6H_6 , indicates the high degree of unsaturation.
2. Open chain structure NOT possible : Open chain or cyclic structure having double and triple bonds can be written for C_6H_6 . But benzene does not behave like alkenes or alkynes (see Table 15.7). This indicates that benzene can not have the open chain structure.

Table 15.7 : Comparative reactivity of alkenes and benzene

Reaction	Alkene	Benzene
With dil. alka. $KMnO_4$	Decolourisation of $KMnO_4$	No decolourisation
With Br_2 in CCl_4	Decolourisation of red brown colour of bromine	No decolourisation
With H_2O in acidic medium	Addition of H_2O molecule	No reaction

3. Evidence of cyclic structure : Benzene yields only one and no isomeric monosubstituted bromobenzene (C_6H_5Br) when treated with equimolar bromine in $FeBr_3$. This indicates that all the six hydrogen atoms in benzene are identical.

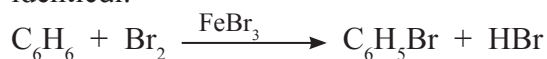

This is possible only if benzene has cyclic structure of six carbons bound to one hydrogen atom each.

Benzene on catalytic hydrogenation gives cyclohexane.

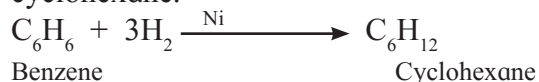

This confirms the cyclic structure of benzene and three $C = C$ in it.

4. Kekulé structure of benzene :

August Kekulé in 1865 suggested the structure for benzene having a cyclic planar ring of six carbon atoms with alternate single and double bonds and hydrogen atom attached to each carbon atom.

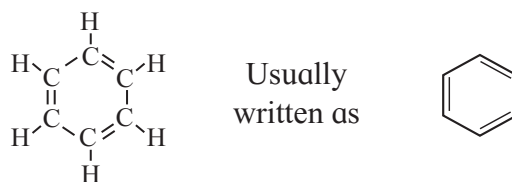

The Kekulé structure indicates the possibility of two isomeric 1,2-dibromobenzenes. In one of the isomers, the bromine atoms would be attached to the doubly bonded carbon atoms whereas in the other, they would be attached to single bonded carbons.

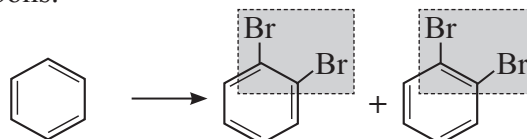

However, benzene was found to form only one ortho-disubstituted benzene. This problem was overcome by Kekulé by suggesting the concept of oscillating nature of double bonds in benzene as given below.



Even with this modification, Kekulé's structure of benzene failed to explain unusual stability and preference to substitution reactions rather than addition reactions, which was later explained by resonance.

5. Stability of benzene:

Benzene is a hybrid of various resonance structures. The two structures, A and B given by Kekulé are the main contributing structures. The resonance hybrid is represented by inserting a circle or a dotted circle inscribed in the hexagon as shown in (C). The circle represents six electrons delocalized over the six carbon atoms of benzene ring.

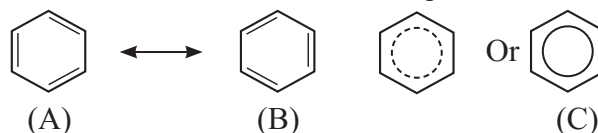

A double-headed arrow between the resonance structures is used to represent the resonance phenomenon.

Stability of benzene : The actual molecule is more stable than any of its resonance structures. For benzene, the stability due to resonance

is so high that π -bonds of the molecule resist breaking. This explains lack of reactivity of benzene towards addition.

The orbital overlap gives us better picture of structure of benzene. All six carbon atoms in benzene are sp^2 hybridised. Two sp^2 hybrid orbitals of carbons overlap and form carbon-carbon sigma (σ) bond and the remaining third sp^2 hybrid orbital of each carbon overlaps with s orbital of a hydrogen atom to form six C-H sigma bonds.

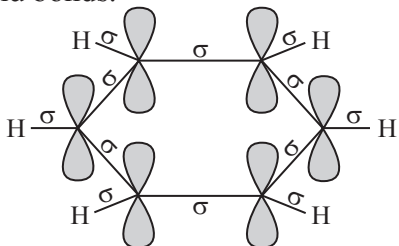

The unhybrid p orbitals of carbon atoms overlap laterally forming π bonds. There are two possibilities of forming three π bonds by overlap of p orbitals of C_1-C_2 , C_3-C_4 , C_5-C_6 or C_2-C_3 , C_4-C_5 , C_6-C_1 , respectively, as shown in Fig. 15.5; both are equally probable. According to **resonance theory** (Chapter 5) these are two resonance structures of benzene.

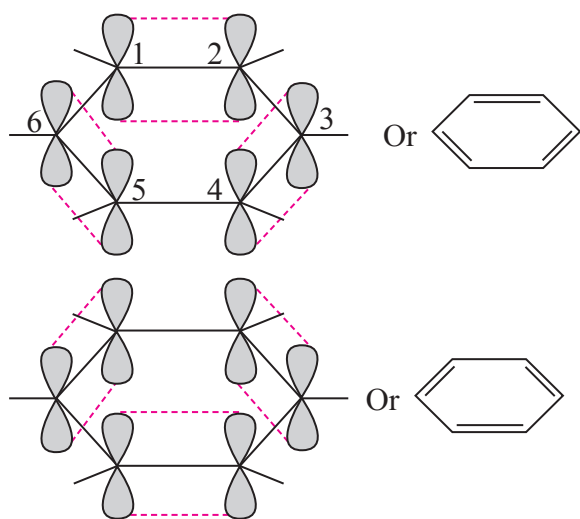

Fig. 15.5 Overlap of p orbitals in benzene

According to **molecular orbital (MO) theory** (Chapter 5) the six p orbitals of six carbons give rise to six molecular orbitals of benzene. Shape of the most stable MO is as shown in Fig. 15.6.

Three of these π molecular orbitals lie above and the other below those of free carbon

atom energies.

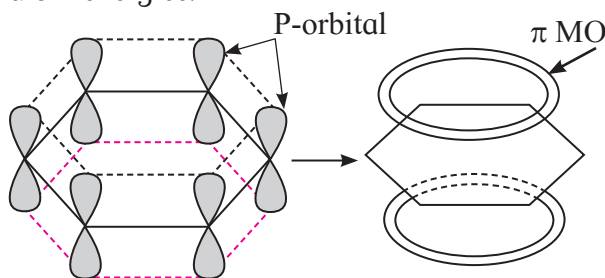
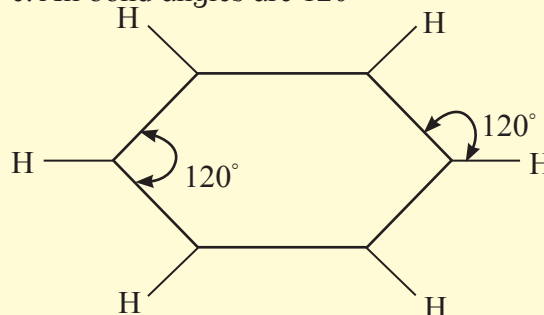

Fig 15.6 : Representative π molecular orbital in benzene



Remember

- All carbon and hydrogen atoms lie in the same plane.
- Six sigma (σ) bonds lie in the same plane.
- All bond angles are 120°



The six electrons of the p orbitals cover all the six carbon atoms and are said to be delocalized. Delocalization of π electrons results in stability of benzene molecule.

6. Bond parameters of benzene : X-ray diffraction data indicate that all C-C bond lengths in benzene are equal (139 pm) which is an intermediate between C-C (154 pm) and C=C bond (133pm). Thus absence of pure double bond in benzene accounts for its reluctance to addition reactions under normal conditions, which explains unusual behaviour of benzene.

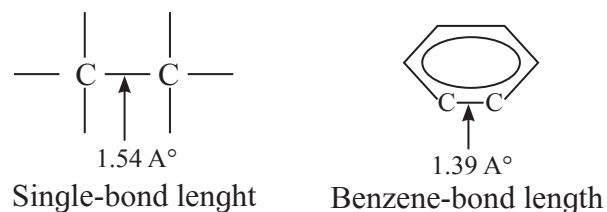

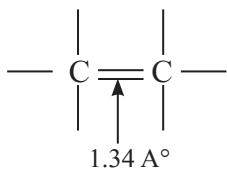

Double-bond length

15.4.3 Aromatic character (Huckel Rule) :

Benzene undergoes substitution reaction rather than addition reactions. This property is common to all aromatic compounds and is referred to as **aromaticity** or **aromatic character**. The aromatic character of benzene is correlated to its structure.

Aromaticity is due to extensive cyclic delocalization of p electrons in planar ring structures.

The following **three rules of aromaticity** are useful in predicting whether a particular compound is

aromatic or non-aromatic.

1. Aromatic compounds are cyclic and planar (all atoms in ring are sp^2 hybridized).
2. Each atom in aromatic ring has a p-orbital. The p-orbitals must be parallel so that continuous overlap is possible around the ring.
3. **Huckel Rule** : The cyclic π molecular orbital formed by overlap of p-orbitals must contain $(4n + 2)$ p electrons, where $n =$ integer 0,1,2,3 ...etc.

Let us apply these rules to the following compounds

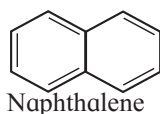
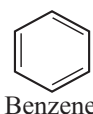

1. Benzene : It is cyclic and planar. It has three double bonds and six π electrons. It has a p orbital on each carbon of the hexagonal ring. Hence a continuous overlap above and below the ring is possible.

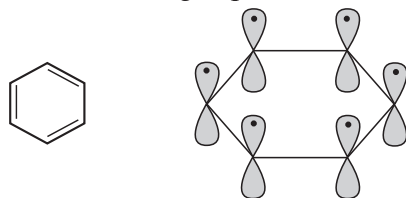

This compound is aromatic, $4n + 2 =$ Number of π electrons.

$4n + 2 = 6,$ $\therefore 4n = 6 - 2 = 4$
 $n = 4/4 = 1,$ Here 'n' comes out to be an integer.
 Hence benzene is aromatic.

2. Naphthalene : It is cyclic and planar. It has 5 double bonds and 10 π electrons. It has p orbital on each carbon atom of the ring. Hence a continuous overlap around the ring is possible. This is in accordance with Huckel rule.

$4n + 2 =$ Number of π electrons
 $4n + 2 = 10,$ $\therefore 4n = 10 - 2 = 8$
 $n = 8/4 = 2,$ Here 'n' comes out to be an integer.
 Hence naphthalene is aromatic.

3. Pyridine : Pyridine has three double bonds and 6 π electrons. The six p orbital containing six electrons form delocalized p molecular orbital. The unused sp^2 hybrid orbital of nitrogen containing two non-bonding electrons is as it is.

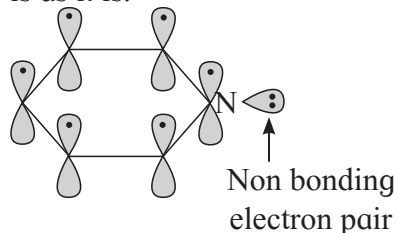

$4n + 2 =$ Number of p electrons
 $4n + 2 = 6,$ $\therefore 4n = 6 - 2 = 4$
 $n = 4/4 = 1,$ Here 'n' comes out to be an integer.
 Hence pyridine is aromatic.

4. Cycloheptatriene : It is cyclic and planar. It has three double bonds and 6 π electrons. But one of the carbons is saturated (sp^3 hybridized) and does not possess a p orbital. Hence a continuous overlap around the ring is not possible. Therefore, it is non- aromatic.

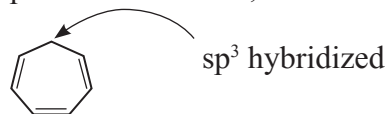

15.4.4 Preparation of aromatic compounds

a. Industrial source of aromatic compounds

Coal tar and petroleum are major sources of aromatic compounds.

b. Methods of preparation of benzene

1. From ethyne (By trimerization) : Alkynes when passed through a red hot iron tube at 873 K, polymerize to form aromatic hydrocarbons.

Ethyne when passed through a red hot iron tube at 873 K undergoes trimerization to form benzene.

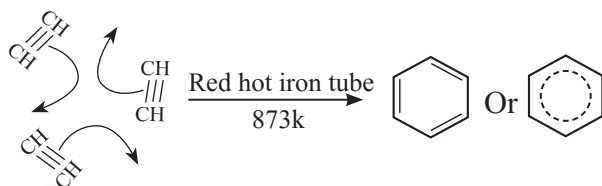

Can you recall?

What is decarboxylation ?

2. From sodium benzoate :

(By decarboxylation)

When anhydrous sodium benzoate is heated with soda-lime it gives benzene.

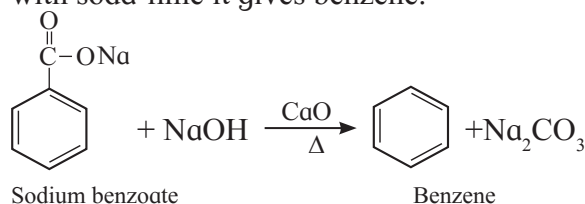

Sodium benzoate

Benzene

3. From phenol (By reduction) : When vapours of phenol are passed over heated zinc dust, it gives benzene.

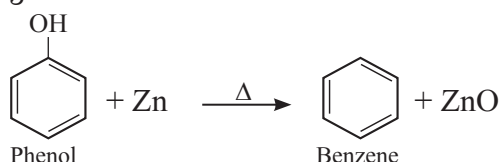

Phenol

Benzene

15.4.5 Physical properties of benzene

1. Benzene is colourless liquid.
2. Its boiling point is 353K and melting point is 278.5 K.
3. It is insoluble in water. It forms upper layer when mixed with water.
4. It is soluble in alcohol, ether, and chloroform.
5. Benzene vapours are highly toxic which on inhalation lead to unconsciousness.

15.4.6 Chemical properties of benzene

Aromatic compounds are characterised by electrophilic substitution reactions. However, they undergo addition and oxidation reactions under special conditions. Some reactions of benzene are discussed below.

I. Addition reactions

i. Addition of chlorine : Benzene when treated with chlorine in presence of bright sunlight or UV light, adds up three molecules of chlorine

to give benzene hexachloride .

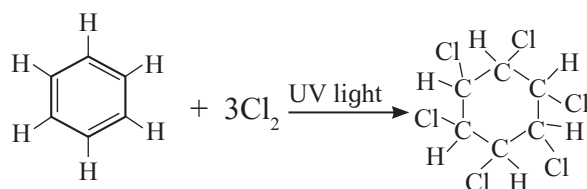

Benzene

Benzene hexachloride (BHC)

γ - isomer of benzene hexachloride is called **gammexane** or **lindane** which is used as insecticide.

ii. Addition of hydrogen : When a mixture of benzene and hydrogen gas is passed over heated catalyst nickel at 453 K to 473 K, cyclohexane is formed.

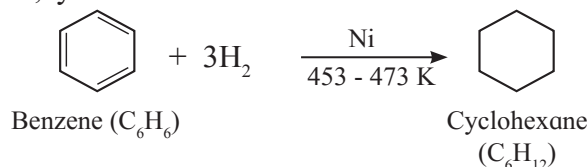

Benzene (C₆H₆)

Cyclohexane (C₆H₁₂)

iii. Addition of ozone : When benzene is treated with ozone in presence of an inert solvent carbon tetrachloride, benzene triozone is formed which is then decomposed by zinc dust and water to give glyoxal.

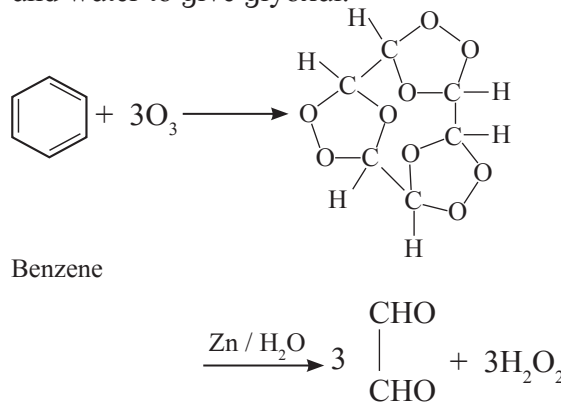

Benzene

Ethanedial or glyoxal

II. Substitution reactions : Benzene shows electrophilic substitution reactions, in which one or more hydrogen atoms of benzene ring are replaced by **electrophilic groups** like -Cl, -Br, -NO₂, -SO₃H, -R (alkyl group) , -COR (Acyl group) etc. (see Chapter 14).

i. Halogenation : In this reaction, hydrogen atom of benzene ring is replaced by halogen atom .

Chlorination

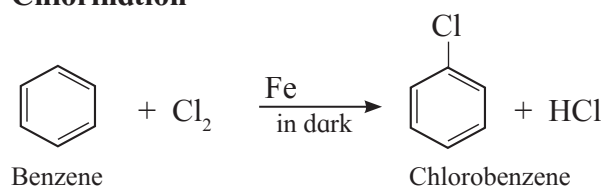

Chlorine reacts with benzene in dark in the presence of iron or ferric chloride or anhydrous aluminium chloride or red phosphorous as catalyst to give chlorobenzene.

Electrophile : Cl[⊕], Chloronium ion

Formation of the electrophile :



Bromination of benzene is similar to chlorination :

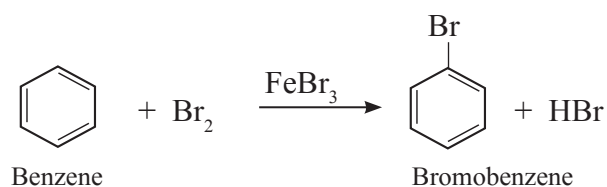

Electrophile : Br[⊕],

Formation of electrophile :

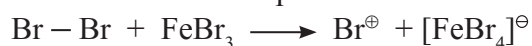

Iodination of benzene is **not possible** as it is reversible process.

With excess of chlorine, benzene gives hexachlorobenzene.

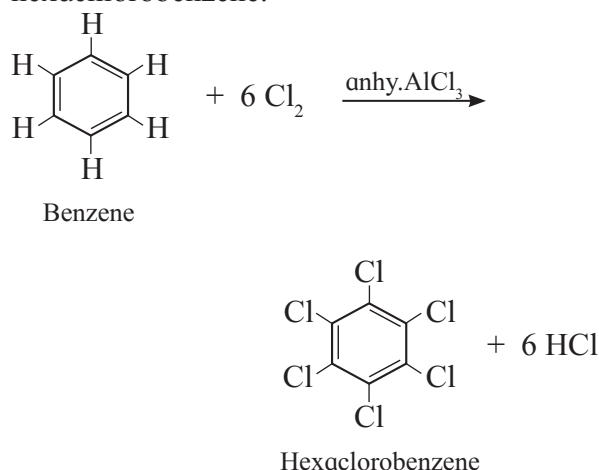

ii. Nitration :

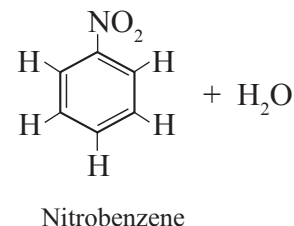
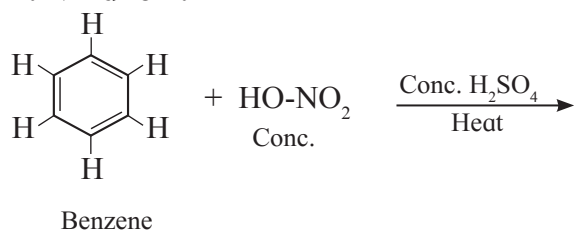

When benzene is heated with a mixture of concentrated nitric acid and concentrated sulfuric acid (nitrating mixture) at about 313 K to 333 K, it gives nitrobenzene.

Electrophile : NO₂[⊕], nitronium ion.

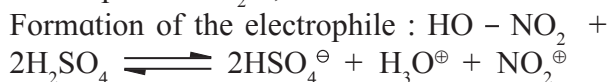

iii. Sulfonation :

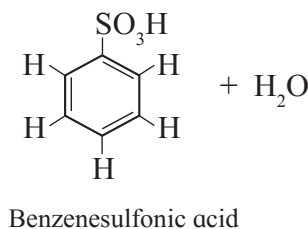
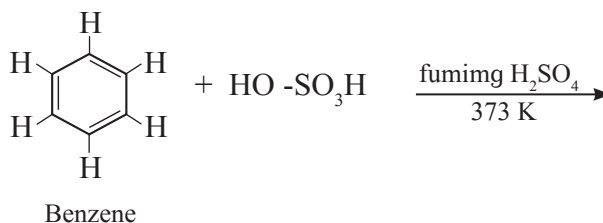

When benzene is heated with fuming sulfuric acid (oleum) at 373 K, it gives benzene sulfonic acid.

Electrophile : SO₃, free sulfur trioxide

Formation of the electrophile :



iv. Friedel-Craft's alkylation reaction :

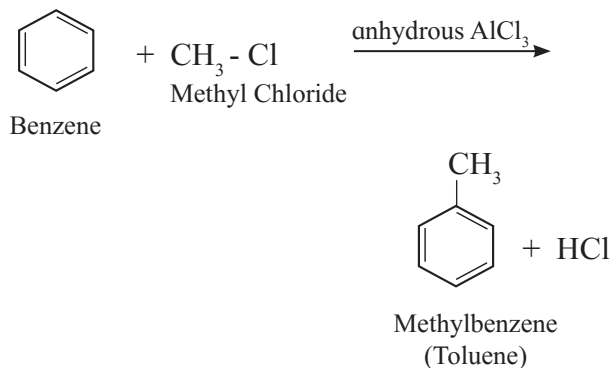

When benzene is treated with an alkyl halide like methyl chloride in the presence of anhydrous aluminium chloride, it gives toluene.

The reaction is used to extend the chain outside the benzene ring.

Electrophile : R^{\oplus}

Formation of the electrophile :

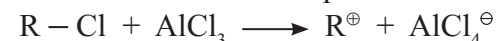

v. Friedel-Craft's acylation reaction :

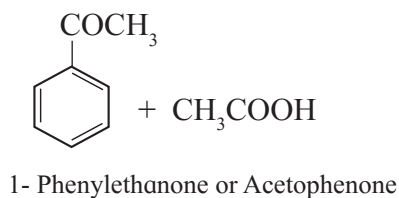
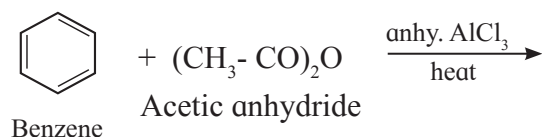
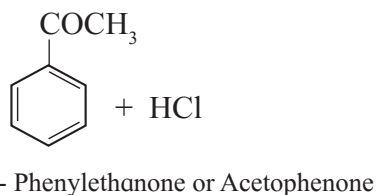
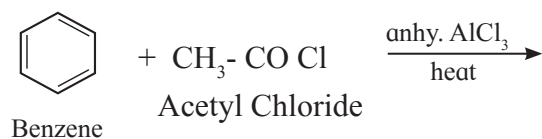

When benzene is heated with an acyl halide or acid anhydride in the presence of anhydrous aluminium chloride, it gives corresponding acyl benzene.

Electrophile : $R-C^{\oplus}=O$ acylium ion

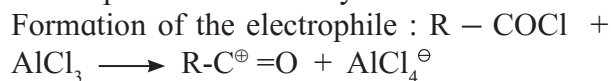

6. Combustion : When benzene is heated in air, it burns with sooty flame forming carbon dioxide and water.



General combustion reaction for any hydrocarbon (C_xH_y) can be represented as follows:

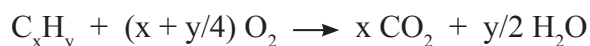

15.4.7 Directive influence of a functional group in monosubstituted benzene

Structure of benzene :

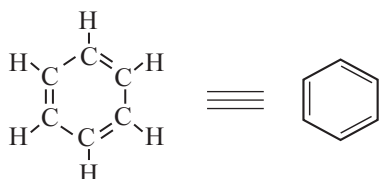

In benzene, all hydrogen atoms are equivalent. Therefore, only one product is possible when it undergoes electrophilic substitution reactions.

Monosubstituted benzene :

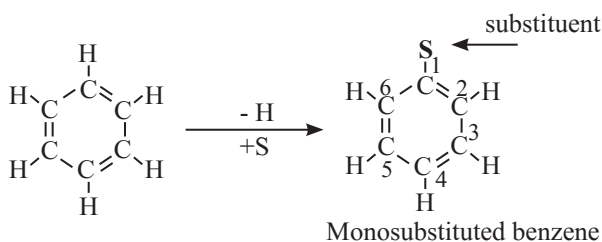

Positions of carbon atoms in mono substituted benzene :

The positions 2 and 6 are equivalent and give ortho (o-) products.

The position 3 and 5 are equivalent and give meta (m-) products.

The position 4 is unique and gives para (p-) product.

Now in benzene, five positions are available for electrophilic substitution.

When monosubstituted benzene is subjected to further electrophilic substitution, the second substituent i.e. electrophile (see Chapter 14) or incoming group (E) can occupy any of these positions and give three disubstituted products. But these products are not formed in equal amounts.

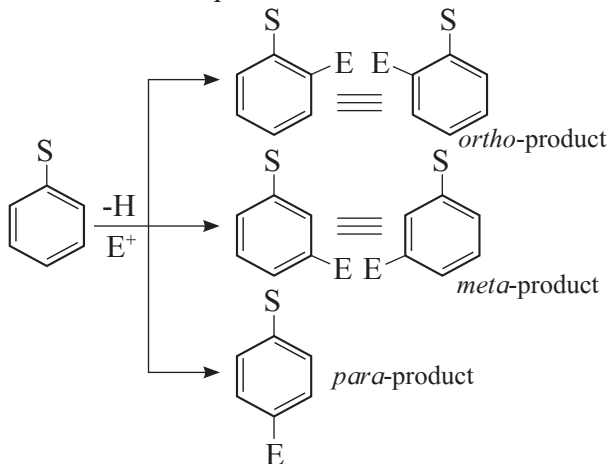

Two types of behaviour are observed.

a. ortho- and para - products or b. meta-products are found as major products :

This behaviour mainly depends on the nature of the substituent (S) already present in the benzene ring and not on the nature of second substituent (E) i.e. incoming group.

Ortho and para directing groups :

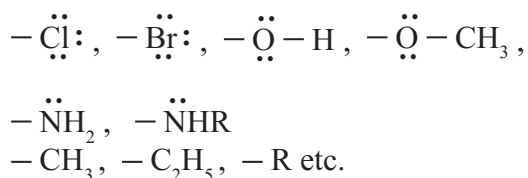

The groups which direct the incoming group to ortho and para positions are called ortho and para directing groups.

Ortho and para directive influence of -OH group : The resonance theory clearly explains why certain substituents are ortho/para or meta directing. Let us study the various resonance structures of phenol (see Chapter 14).

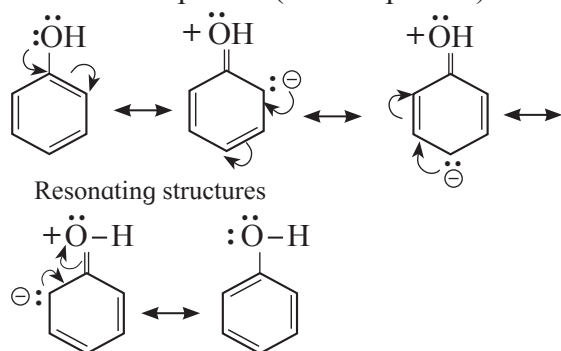

It is clear from the above resonance structures that the ortho and para positions have a greater electron density than the meta positions. Therefore, -OH group activates the benzene ring for the attack of second substituent E at these electron -rich centres.



Remember

Due to -I effect of -OH group (see Chapter 14), the electron density on ortho positions of the benzene ring gets slightly reduced. Thus resonance effect and inductive effect of OH group act opposite to each other.

All ortho and para directing groups possess nonbonding electron pair on the atom which is directly attached to aromatic ring.

Methyl group is an exception : The only exception to above rule is methyl or alkyl groups. It is ortho and para directing, although it has no nonbonding electron pair on the key atom. This is explained on the basis of special

type of resonance called hyperconjugation or no bond resonance (see Chapter 14).

In case of **aryl halides**, halogens are moderately deactivating. Because of their strong -I effect, overall electron density on the benzene ring decreases. It makes the electrophilic substitution difficult. However, due to resonance the electron density on ortho and para positions is greater than meta positions. Halogens are ortho and para directing.

Let us study the various resonating structures of chlorobenzene.

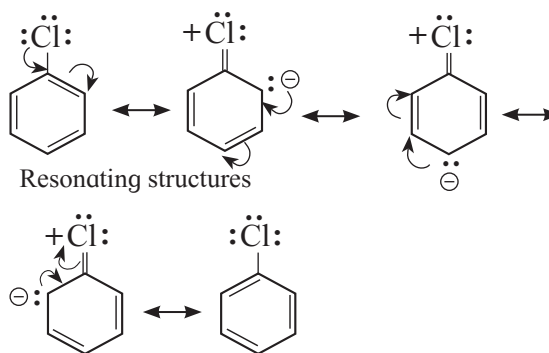

Meta directing and deactivating groups

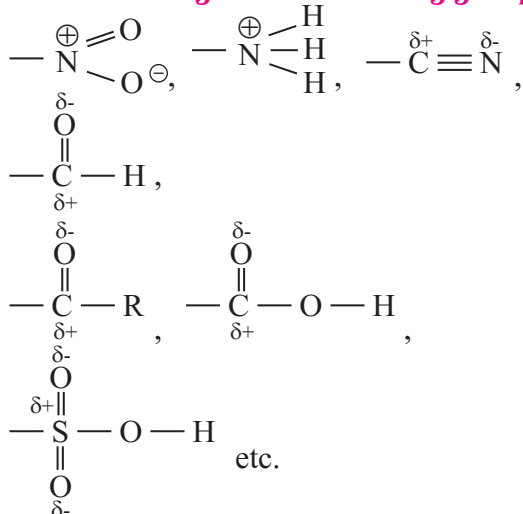

All meta directing groups have positive (or partial positive) charge on the atom which is directly attached to an aromatic ring.

The groups which direct the incoming group to meta positions are called **meta directing groups**.

Metadirective influence of $-\text{NO}_2$ group can be explained by resonance theory : Meta directing group withdraws electrons from the aromatic ring by resonance, making the ring electron-deficient. Therefore, meta groups are ring deactivating groups. Due to -I effect, $-\text{NO}_2$ group reduces electron density in benzene ring on ortho and para positions. So the attack of incoming group becomes difficult at ortho and para positions. Incoming group can attack on meta positions more easily. Let us study the various resonance structures of nitrobenzene.

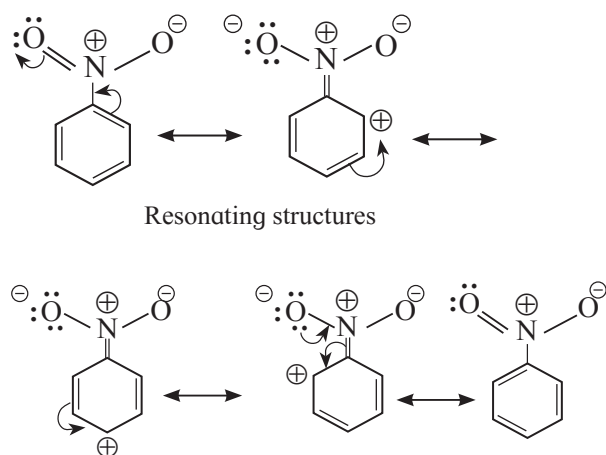

It is clear from the above resonance structures that the ortho and para positions have comparatively less electron density than at meta positions. Hence, the incoming group/electrophile attacks on meta positions.

15.4.6 Carcinogenicity and Toxicity :

Benzene is both toxic and carcinogenic (cancer causing). In fact, it might be considered "the mother of all carcinogens" as a large number of carcinogens have structures those include benzene rings. Several polycyclic aromatic compounds (containing more than two fused benzene rings) are produced by incomplete combustion of tobacco, coal and petroleum. In liver, benzene is oxidized to an epoxide. Benzopyrene is converted into an epoxy diol. These substances are carcinogenic and can react with DNA which can induce mutation leading to uncontrolled growth of cancer cells.



Internet my friend

1. chemed.chem.purdue.edu>1organic>Organic Chemistry
2. www.ncert.nic.in>ncerts>kech206(pdf)
3. <https://www.britannica.com>>science>benzene
4. <https://pubchem.ncbi.nlm.nih.gov>>Benzene



Exercises

1. Choose correct options

- A. Which of the following compound has highest boiling point ?
a. n-pentane
b. iso-butane
c. butane
d. neopentane
- B. Acidic hydrogen is present in :
a. acetylene
b. ethane
c. ethylene
d. dimethyl acetylene
- C. Identify 'A' in the following reaction:
$$\text{CH}_3 - \underset{\text{CH}_3}{\underset{|}{\text{C}}} = \text{CH}_2 \xrightarrow{\text{A}}$$

$$\text{CH}_3 - \underset{\text{O}}{\underset{||}{\text{C}}} - \text{CH}_3 + \text{CO}_2 + \text{H}_2\text{O}$$

a. KMnO_4/H^+
b. alkaline KMnO_4
c. dil. $\text{H}_2\text{SO}_4/1\% \text{HgSO}_4$
d. $\text{NaOH}/\text{H}_2\text{O}_2$
- D. Major product of chlorination of ethyl benzene is :
a. m-chlorethyl benzene
b. p - chloroethyl benzene
c. chlorobenzene
d. o - chloroethylbenzene
- E. 1 - chloropropane on treatment with alc. KOH produces :
a. propane
b. propene
c. propyne
d. propyl alcohol

2. Name the following :

- A. The type of hydrocarbon that is used as lubricant.
B. Alkene used in the manufacture of polythene bags.
C. The hydrocarbon said to possess carcinogenic property.
D. What are the main natural sources of alkane?

- E. Arrange the three isomers of alkane with molecular formula C_5H_{12} in increasing order of boiling points and write their IUPAC names.
- F. Write IUPAC names of the products obtained by the reaction of cold concentrated sulphuric acid followed by water with the following compounds.
a. propene b. but-1-ene
- G. Write the balanced chemical reaction for preparation of ethane from
a. Ethyl bromide
b. Ethyl magnesium iodide
- H. How many monochlorination products are possible for
a. 2-methylpropane ?
b. 2-methylbutane ?
Draw their structures and write their IUPAC names.
- I. Write all the possible products for pyrolysis of butane.
- J. Which of the following will exhibit geometrical isomerism ?
a. $\text{CH}_3 - \text{CH}_2 - \underset{\text{CH}_2}{\underset{||}{\text{C}}} - \text{CH}_3$
b. $(\text{CH}_3)_2\text{C} = \text{CH}_2$
c. $\text{CH}_3 - \underset{\text{C}_2\text{H}_5}{\underset{|}{\text{C}}} = \underset{\text{C}_2\text{H}_5}{\underset{|}{\text{C}}} - \text{CH}_3$
- K. What is the action of following on ethyl iodide ?
a. alc, KOH
b. Zn, HCl
- L. An alkene 'A' an ozonolysis gives 2 moles of ethanal. Write the structure and IUPAC name of 'A'.
- M. Acetone and acetaldehyde are the ozonolysis products of an alkene. Write the structural formula of an alkene and give IUPAC name of it.
- N. Write the reaction to convert
a. propene to n-propylalcohol.
b. propene to isopropyl alcohol.

- O. What is the action of following on but-2-ene ?
 a. dil alkaline KMnO_4
 b. acidic KMnO_4
- P. Complete the following reaction sequence :
 $\text{HC} \equiv \text{CH} \xrightarrow{\text{LiNH}_3} \text{A} \xrightarrow{\text{CH}_3\text{CH}_2\text{Cl}} \text{B} \xrightarrow{\text{HBr}} \text{C}$
 Comment on the acidic nature of B.
- Q. Write the balanced chemical reactions to get benzene from
 a. Sodium benzoate.
 b. Phenol.
- R. Predict the possible products of the following reaction.
 a. chlorination of nitrobenzene,
 b. sulfonation of chlorobenzene,
 c. bromination of phenol,
 d. nitration of toluene.

3. Identify the main product of the reaction

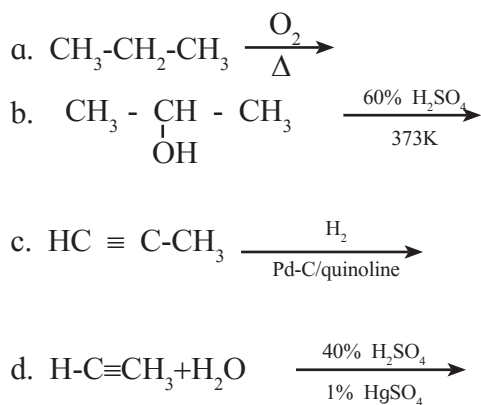

4. Read the following reaction and answer the questions given below.

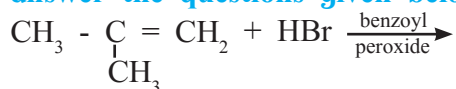

- a. Write IUPAC name of the product.
 b. State the rule that governs formation of this product.
5. Identify A, B, C in the following reaction sequence :

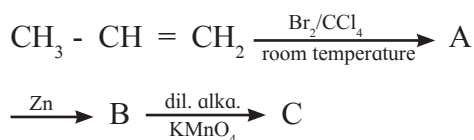

6. Identify giving reason whether the following compounds are aromatic or not.

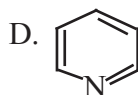
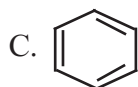
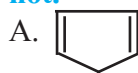

7. Name two reagents used for acylation of benzene.

8. Read the following reaction and answer the questions given below.

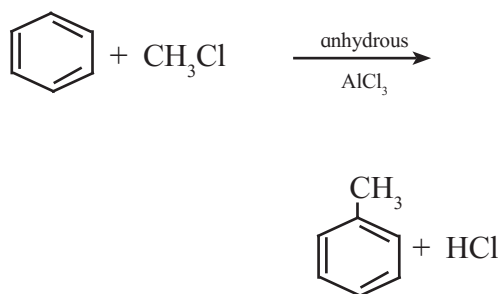

- A. Write the name of the reaction.
 B. Identify the electrophile in it.
 C. How is this electrophile generated?



Activity :

Prepare chart of hydrocarbons and note down the characteristics.

16. Chemistry in Everyday Life



Can you recall?

1. What are the components of balanced diet ?
2. Why is food cooked ? what is the difference in the physical states of uncooked and cooked food?
3. What are the chemicals that we come across in everyday life ?

The life, the atmosphere, the earth and the universe, all have evolved over billions of years to the present state. The evolution continues progress and accompanied by a variety of chemical changes. Natural phenomena such as weathering, lightening, irruption of volcanoes, photosynthesis, ripening of fruit, fermentation, release of fragrance by blooming flowers and many others take around us involve intricate chemistry. Chemistry is involved in a variety of life processes those occur within and across our body. Human civilization in different regions of the world discovered uses of various plant, animal and mineral products for benefits of human life. With the advent of modern science, scientist discovered structures of various constituent chemicals in natural materials. Synthetic organic chemistry has led to advancement in science. Synthesis of natural molecules and new molecules with structural variation revolutionalized materials are used in all the walks of human life. This influence is seen in all aspects of the basic needs, such as food, clothing, shelter and beyond.

In this chapter, we consider some aspects of **food chemistry**, **medicinal chemistry** and **chemistry of cleansing materials** with reference to compounds having simple structural features.

16.1 Basics of food chemistry

Food provides **nutrients** these are used by the body as the source of energy. These nutrients also regulate growth, maintain and repair body tissues. The nutrients comprise carbohydrates, lipids, proteins, vitamins, minerals and water. Grains, fruits and vegetables provide carbohydrates and vitamins; meat, fish, eggs, dairy products and pulses provide proteins and vitamins. Lipids are provided by vegetable oils, dairy products and animal fats.

Most nutrients are organic macromolecules. **Proteins** and **carbohydrates** are **polymeric** materials. As a result of food **digestion**, the polymeric proteins and carbohydrates ultimately break down into monomers, namely, α - **amino acids** and **glucose**, respectively, under the influence of **enzymes**. Cooking makes food easy to digest. During the cooking process, high polymers of carbohydrates or proteins are hydrolysed to smaller polymers. The uncooked food mixture, described as heterogeneous suspension, becomes a colloidal matter on cooking. Because of smaller size of the resulting constituent nutrient molecules, **cooked food** is easier to digest than the uncooked food.

16.1.2 Food quality chemistry :



Just think

1. Why is food stored for a long time ?
2. What methods are used for preservation of food ?
3. What is meant by quality of food ?

Quality of food is an important aspect of food chemistry. Food quality is described in terms of parameters such as flavour, smell, texture, colour and microbial spoilage. Enzymes are present naturally in all foods.

Quality of foods changes on shelving mostly due to enzyme action, chemical reactions with the environment and the action of microorganisms. Some of these effects are beneficial. For example, setting of milk into curd and raising flour dough to make bread is brought about by deliberate action of microorganisms. Most changes brought about by microorganisms and interaction with the environment however, adversely affect the food quality.

Problem 16.1

How are the chemical reactions of food stuff with the environment controlled during storage ?

Solution :

Primarily the oxygen and microorganisms in air are responsible for adverse effects on stored food. The exposure of stored food to atmosphere is minimized by storing them in air tight container, evacuation or filling the container with N_2 gas. Rate of a chemical reaction decreases with the lowering of temperature. Thus refrigeration is useful for controlling chemical reaction of food stuff with environment. The reactions of food stuff with environment are catalyzed by enzymes. Due to boiling, the enzymes become denatured and the reactions are controlled.

Food preservation and food processing methods aim at prevention of undesirable changes and attempt about desirable changes in food. The following cases illustrate some aspects of food quality and the underlying chemistry.

i. Browning of cut fruit/vegetables : When fruits such as banana, apple or vegetables such as potato, bottlegourd are peeled and sliced, sooner or later they turn brown. Cutting action damage the cells resulting in release of chemicals. With the pH prevailing in fruit/vegetables, the polyphenols released are oxidised with oxygen in air owing to action from an enzyme to form quinones.

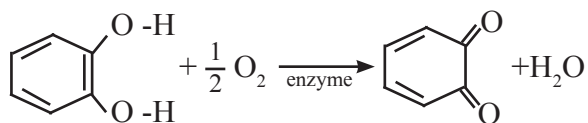

a poly phenol

a quinone

Quinones undergo further reactions including polymerization giving brown coloured products named **tannins**. This browning reaction can be slowed down using reducing agents such as SO_2 , ascorbic acid (vitamin C) or by change of pH by adding edible acid such as lemon juice (citric acid) or vinegar.

ii. Rancidity of oils and fats : On keeping for long time, oils and fats develop an unpleasant or **rancid** smell and disagreeable taste. Fats are triesters of fatty acids (long chain carboxylic acids) and glycerol (propane - 1, 2, 3 - triol). One cause of rancidity is release of fatty acids produced during hydrolysis of fats brought about by water present in food.

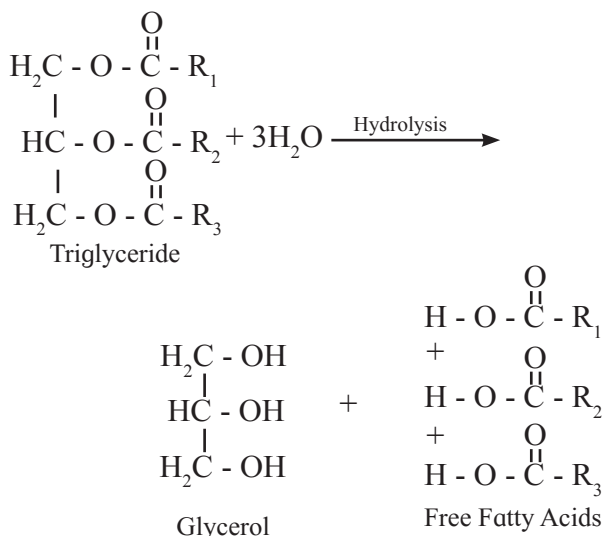

The hydrolysis of fats occurs rapidly in the presence of certain microorganisms and is an enzyme catalysed reaction. Rancidity of milk and butter is due to the release of four, six and eight carbon fatty acids (butanoic, hexanoic and octanoic acids) on hydrolysis. Chocolate develops oily or fatty flavour due to release of palmitic, stearic and oleic acids on hydrolysis. Lauric acid on hydrolysis gives a soapy flavour to coconut oil.

The second cause of rancidity of oils and fats is **oxidation** by molecular oxygen in the air. Many vegetable oils have one or more C=C double bonds in the fatty acid part of their structure. These are called mono or poly unsaturated fats. The unsaturated fat molecules break down during the oxidation and form **volatile aldehydes** and **carboxylic acids** which give the unpleasant rancid taste. This is called **oxidative rancidity**. It is caused by **free radical** reaction initiated by light (photo oxidation) or catalysed by either enzymes or metal ions. Polyunsaturated oils containing greater number of C=C double bonds and usually become rancid very quickly. High temperature increases the rate of air oxidation of unsaturated fats. Extensive oxidation can lead to some **polymerization** with consequent increase in viscosity and browning.

iii. Saturated, unsaturated and trans fats :



Can you recall?

1. How is Vanaspati Ghee made ?
2. What are the physical states of peanut oil, butter, animal fat, vanaspati ghee at room temperature ?

You have noted earlier that fats are triglycerides of fatty acids. Animal fats mostly contain saturated fatty acids, while vegetable oils contain unsaturated fatty acids as well. Long chains of tetrahedral carbon atoms in a saturated fatty acid get packed closely together. Moreover, van der Waal's forces between the long saturated chains are sufficiently strong to convert saturated fats into solid form at room temperature.

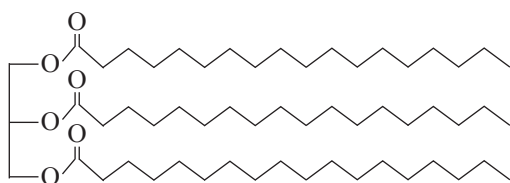

a. A saturated fat molecule

The long carbon chains of unsaturated fatty acids contain one or more C=C double bonds. This produces one or more '**kinks**' in the chain, (see the Fig. 16.1) which prevent the molecules from packing closely together. The van der Waals forces between the unsaturated chains are weak. The melting points of unsaturated fats therefore, are lower.

Natural fats are mixtures of triglycerides. They do not have sharp melting points, and usually melt over a range of temperatures. The more unsaturated the fat lower is its melting point and less crystalline it is. Some examples of fats are given in Table 16.1.

A C=C can have geometrical isomers **cis** and **trans**. In the **cis** form of an unsaturated fatty acid the two hydrogens on the two double bonded carbons are on the same side of the double bond, whereas they are on the opposite sides in the **trans** isomer. The **cis** isomer is the most common form of unsaturated fats. The **trans** form occurs only in animal fats and processed unsaturated fats. **Trans fats** are **difficult to metabolize** and may build up to dangerous levels in fatty tissue.

Fats in the form of **lipoprotein** are used in the body for transport of cholesterol. Excessive low density lipoprotein (**LDL**) results in deposition of **cholesterol in blood vessels**, which in turn, results in the increased risk of cardio vascular disease. There is some evidence that eating large amounts of saturated or trans unsaturated fats, increase the tendency of cholesterol getting deposited in blood vessels. Cis fats do not cause formation of such deposits and decrease chance of developing coronary heart disease.

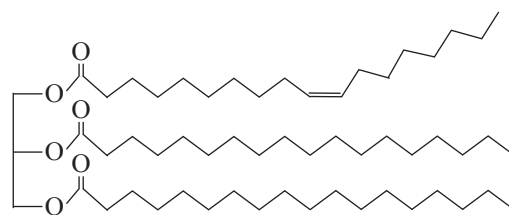

b. An unsaturated fat molecule.

Fig. 16.1 Molecular shapes of fats (A schematic representation)

Table 16.1 : Natural fats and their physical states

Mainly Saturated fats	Mainly mono-unsaturated fats	Mainly poly-unsaturated fats
Coconut fat/oil, butter fat, lard, margarine, vanaspati ghee	Olive oil, peanut oil, canola oil	Safflower oil, sunflower oil, soyabean oil, corn oil, fish oil
solid	liquid	liquid

iv. Omega-3 : Two categories of the natural unsaturated fats of concern include those containing either Omega-3 or Omega-6 fatty acids. These names are given for the position of the double bond in a long carbon chain of the fatty acid. Omega denotes the last carbon of the carbon chain. Omega-3 fatty acids have C=C bond between the third and fourth carbon from the end of a carbon chain.

For example : Linolenic Acid
(9,12,15-octadecatrienoic acid)

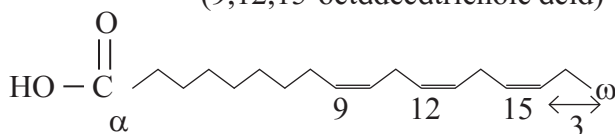

Omega-3 fats are found to raise the High density lipoprotein HDL (good cholesterol) level of blood. On the contrary, Omega-6 fats are considered to have risk of high blood pressure. Foods such as walnuts, flaxseeds, chia seeds, soyabeans, cod liver oil are rich source of Omega-3 fatty acids.

v. Antioxidants as food additives : An antioxidant is a substance that delays the onset of oxidation or slows down the rate of oxidation of food stuff. It is used to extend the shelf life of food. Antioxidants react with oxygen-containing free radicals and thereby prevent oxidative rancidity.

For example, vitamin E (tocopherol) is

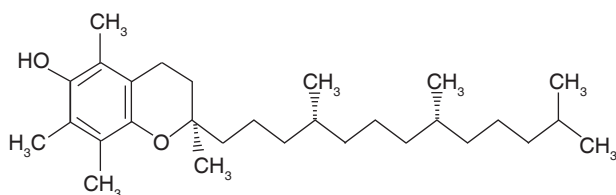

Vitamin E (Tocopherol)

a very effective natural antioxidant which is added to pack edible oils. The phenolic OH group in its structure is responsible for its antioxidant activity, while the long chain of

saturated carbons makes it fat soluble. It is found in foods such as wheat germ, nuts, seeds, green leafy vegetables and oils like safflower oil.

For economic reason **synthetic antioxidants** are used as additives to increase the shelf-life of packed foods. Common structural units found in synthetic antioxidants are phenolic OH group and tertiary butyl group. For example BHT, which is 3, 5-di-tert-butyl-4-hydroxytoluene.

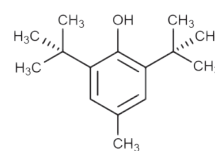

BHT

16.2 Compounds with medicinal properties



Can you tell?

1. What type of medicine is applied to a bruise ?
2. When is an antipyretic drug used ?
3. What is meant by a broad spectrum antibiotic ?
4. What is the active principle of cinnamon bark ?

A chemical which interacts with biomolecules such as carbohydrates, lipids, proteins and nucleic acid and produces a biological response is called **drug**. A drug having therapeutic and useful biological response is used as **medicine**. A medicine contains a drug as its **active ingredient**. Besides it contains some additional chemicals which make the drug suitable for its use as medicine. Medicines are used in diagnosis, prevention and treatment of a disease.

Drugs being foreign substances in a body, often give rise to undesirable, adverse side effects.

Drug design is an important branch of medicinal chemistry which aims at synthesis of new molecules having better biological response. There is an increasing trend in the current research in medicinal chemistry to take cognizance of traditional medical knowledge such as Ayurvedic medicine or natural materials to discover new drugs.

In this section, we consider some simple compounds having medicinal properties and active ingredients of some natural materials those are traditionally known to possess medicinal properties.



Do you know ?

The drug manufacturing companies usually have a patent for drugs which are sold with the brand name. After the expiry of patent the drug can be sold in the name of its active ingredient. These are called generic medicines.

16.2.1 Analgesics and antipyretics

'Algesis' is a Greek word meaning 'feeling of pain.' Drugs which give relief from pain are called analgesics. About half of the analgesics are anti-inflammatory drugs, which kill pain by reducing inflammation or swelling. Antipyretics are used to reduce fever.

Pain-killing and fever reducing properties of an extract of bark of willow plant (commonly found in Europe) have been known for centuries. In nineteenth century its active ingredient, **salicylic acid** (2-hydroxybenzoic acid) was isolated and purified. The compound **aspirin** which is acetyl derivative of salicylic acid was found to have a fewer side effects than salicylic acid. It is one of the most widely used analgesic to date. It however, retains stomach irritating side effects of salicylic acid. A less problematic pain-killer is **paracetamol**, which is a phenol.

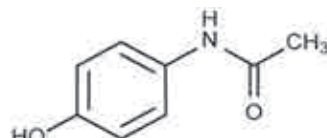
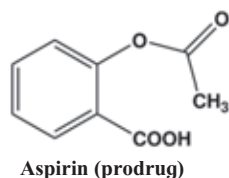
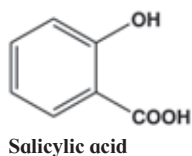

Molecular structure of paracetamol

16.2.2 Antimicrobials : The name **antimicrobial** is an umbrella term for any drug that inhibits or kills microbial cells that include bacteria, fungi and viruses. **Disinfectants** are non-selective antimicrobials, which kill a wide range of microorganisms including bacteria. Disinfectants are used on non-living surfaces for example, floors, instruments, sanitary ware and many others. **Antiseptics** are used to sterilise surfaces of living tissue when the risk of infection is very high, such as during surgery, on wounds and so on. **Antibiotics** are a type of antimicrobial designed to target bacterial infections within or on the body.

a. Antiseptics and disinfectants : Commonly used antiseptics include **inorganics** like iodine and boric acid or **organics** like iodoform and some phenolic compounds. Tincture of iodine (a 2 - 3 percent solution of iodine in alcohol- water mixture) and iodoform serve as powerful antiseptics and find use to apply on wounds. A dilute aqueous solution of boric acid is a weak antiseptic used for eyes. Various phenols are used as antiseptics and disinfectants. A dilute aqueous solution of phenol (known as **carbolic acid**) was one of the first antiseptic used in medicine in the late nineteenth century. It was however, found to be corrosive. Many chloro derivatives of phenols have been realized as more potent antiseptics than the phenol itself. They can be used with much lower concentrations, which reduce their corrosive effects. Two of the most common phenol derivatives in use are trichlorophenol (TCP) and chloroxylenol. The latter is the active ingredient (4.8 % W/V) of the popular antiseptic dettol. The other ingredients of dettol are isopropyl alcohol, pine oil, castor oil soap, caramel and water. Thymol obtained from oil of thyme (a spice plant) is an excellent non-toxic antiseptic. The p-chlorobenzyl phenol is used as disinfectant in all purpose cleaners.

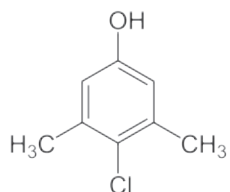

Chloroxylenol

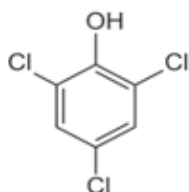

2, 4, 6 Trichlorophenol

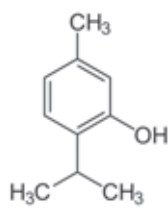

Thymol

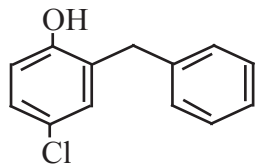

p - Chloro - o - benzylphenol

b. Antibiotics : Antibiotics are purely synthetic or obtained from microorganisms (bacteria, fungi or molds). Arsenic compounds were known to be highly poisonous to humans since long. **Paul Ehrlich**, German bacteriologist investigated arsenic based organic compounds in order to produce less toxic substances for the treatment of syphilis. He discovered the first effective treatment of syphilis, the synthetic antibiotic named **salvarsan**. He was awarded the Nobel prize for medicine (1908) for this discovery. Ehrlich noticed similarity in the structures of salvarsan and azodyes. With further investigations he succeeded in synthesis of an effective diazo antibacterial, prontosil, in 1932. Subsequently it was discovered that prontosil gets converted into a simpler compound sulphanilamide in our body. This gave further direction to research in drug design which led to discovery of a wide range of sulpha drugs, analogues to sulphanilamide. One of the most effective being **sulphapyridine**.

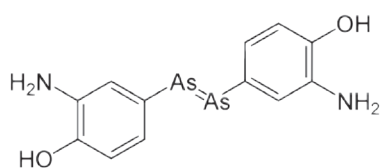

Salvarsan

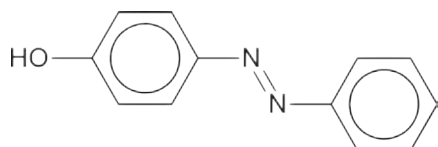

Azodye

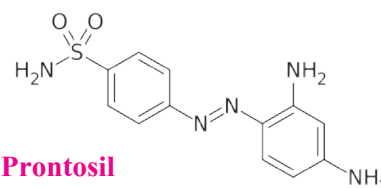

Prontosil

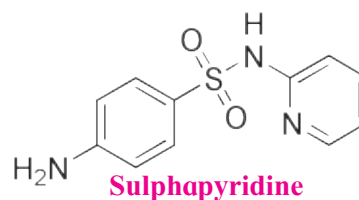

Sulphapyridine

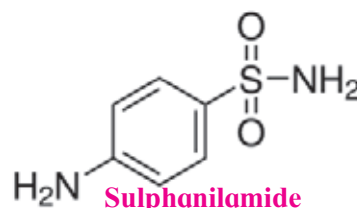

Sulphanilamide

In 1929, **Alexander Fleming** discovered the antibacterial properties of a penicillium fungus. The clinical utility of the purified active ingredient penicillin as antibiotic drug was established in the next thirteen years. This is the first antibiotic of microbial origin. Chloramphenicol, isolated in 1947 is another antibiotic of microbial origin.

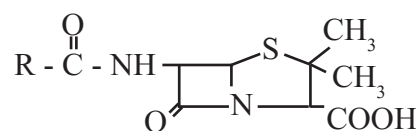

General structure of penicillin

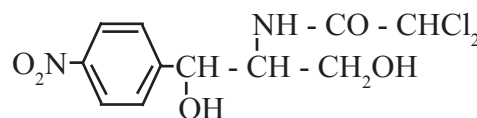

Chloramphenicol

Antibiotics can be of three types : broad spectrum (effective against wide range of bacteria), narrow spectrum (effective against one group of bacteria) or limited spectrum (effective against single organism).

A disadvantage of broad spectrum antibiotics is that they also kill the useful bacteria in the alimentary canal. Today many broad spectrum, narrow spectrum and limited spectrum antibiotics are known. They are synthetic, semisynthetic or of microbial origin.

6.2.3 Traditional knowledge in medicine



Do you know ?

The turmeric patent battle :

India won the legal against US patent and Trademark office (PTO) in 1997 and protected its intellectual property of traditional Indian knowledge about turmeric against patenting. Dr. Raghunath Mashelkar, the then Director General of the council of Scientific and Industrial Research, New Delhi, India led this case and upheld the national pride. In this year long battle the CSIR argued that turmeric, a native Indian plant, had been used for centuries by its people for wound healing.

Since ancient times, in India, many *grandma remedies* are practised for curing ailments. The ancient medicinal system of India has documented medicinal uses of innumerable Indian plants. There is an increasing trend in the modern medicinal chemistry to make use of the traditional knowledge from various parts of world, to isolate active ingredients from medicinal plants and further develop new drugs. Table 16.2 enlists a few medicinal plants, their medicinal property and active ingredients therein.

Table 16.2 Active ingredients of some medicinal plants

Plant	Medicinal property	Name and structure of the active ingredient
Turmeric	antiseptic	<p>Curcumin</p>
Wintergreen	analgesic	<p>Methyl salicylate</p>
Cinnamon	antimicrobial for colds	<p>Cinnamaldehyde</p>
Clove	antimicrobial, analgesic	<p>Eugenol</p>
Citrus fruits	antioxidant	<p>Vitamin C (ascorbic acid)</p>
Indian gooseberry (amla)	antidiabetic, antimicrobial antioxidant	<p>Vitamin C, Gallic acid</p>

16.3 Cleansing Agents : Cleansing agents are substances which are used to remove stain, dirt or clutter on surfaces. They may be natural or synthetically developed.



Can you tell?

- Can we use the same soap for bathing as well as cleaning utensils or washing clothes? Why?
- How will you differentiate between soaps and synthetic detergent using borewell water?

16.3.1 Types of cleansing agents : Commercially cleansing agents are mainly of two types depending upon chemical composition : **soaps** and **synthetic detergents**.

a. Soaps : Soaps are sodium or potassium salts of long chain fatty acids. They are obtained by alkaline hydrolysis of natural oils and fats with NaOH or KOH. This is called **saponification** reaction. Chemically oils are triesters of long chain fatty acids and propan-1, 2,3-triol commonly known as **glycerol** or **glycerin**. Saponification of oil produces soap and glycerol.

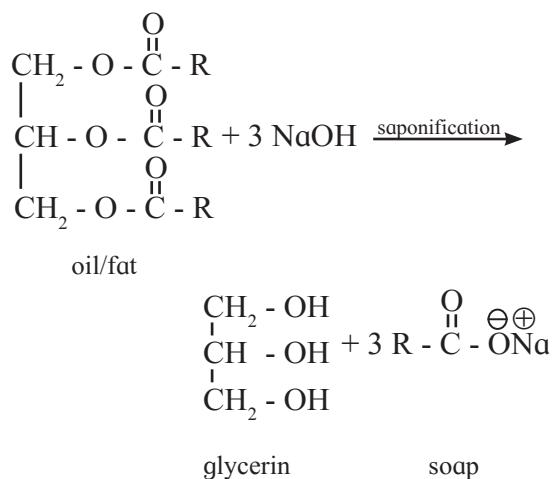

The quality of soap depends upon the nature of oil and alkali used. Potassium soaps are soft to skin. Therefore toilet soaps are prepared by using better grades of oil and KOH. Care is taken to remove excess of alkali. Laundry soaps are made using NaOH. These also contain fillers like sodium rosinate (a lathering agents), sodium silicate, borax, sodium and trisodium phosphate.

Hard water and soap : Soaps are water soluble. They form scum in hard water and become inactive. This is because hard water contains dissolved salts of calcium and magnesium, which react with soap, precipitating calcium or magnesium salt of fatty acid (scum) which sticks to fabric.



Washing soda (Na_2CO_3) precipitates the dissolved calcium salts as carbonate and helps the soap action by softening of water.

b. Synthetic detergents : Synthetic detergents are man made cleansing agents designed to use even in hard water. There are three types of synthetic detergents, anionic detergents, cationic detergents and nonionic detergents.

i. Anionic detergents are sodium salts of long chain alkyl sulphonic acids or long chain alkyl substituted benzene sulphonic acids. ii. Cationic detergents are quaternary ammonium salts having one long chain alkyl group. iii. Nonionic detergents are ethers of polyethylene glycol with alkyl phenol or esters of polyethylene glycol with long chain fatty acid. Table 16.3 displays some synthetic detergents.

Mechanism of cleansing action : Soaps and detergents bring about cleansing of dirty, greasy surfaces by the same mechanism. Dirt is held at the surface by means of oily matter and, therefore, cannot get washed with water. The molecules of soaps and detergent have two parts. One part is polar (called head) and the other part is long nonpolar chain of carbons (called tail).

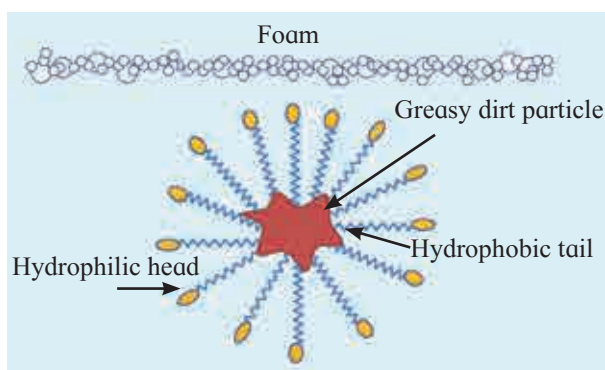
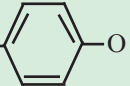

Fig. 16.2 : Soap micelle at work

The polar head (**hydrophilic**) can dissolve in water which is polar solvent. The nonpolar tail (**hydrophobic**) dissolve in oil/fat/grease. The molecules of soap/detergent are arranged around the oily droplet such that the nonpolar tail points towards the central oily drop while the polar head is directed towards the water. (see Fig. 16.2) Thus, micelles of soap/detergent are formed surrounding the oil drops, which are removed in the washing process.

Table 16.3 Synthetic detergents

Type	Example	Use
Anionic detergent	(sodium lauryl sulphate) $\text{CH}_3(\text{CH}_2)_{10}\text{CH}_2\text{OSO}_3^-\text{Na}^+$	Household detergent, additive in toothpaste
Cationic detergent	$\text{CH}_3(\text{CH}_2)_{15}-\text{N}^+(\text{CH}_3)_3\text{Br}^-$ (ethyltrimethyl ammonium bromide)	hair conditioner, germicide
Nonionic detergent	$\text{CH}_3(\text{CH}_2)_{16}-\text{COO}(\text{CH}_2\text{CH}_2\text{O})_n\text{CH}_2\text{CH}_2\text{OH}$ (an ester)	liquid dishwash
	C_9H_{19}  $-(\text{CH}_2\text{CH}_2\text{O})_n\text{CH}_2\text{CH}_2\text{OH}$ (an ether)	liquid detergent



Exercises

1. Choose correct option

- Oxidative Rancidity is reaction
 - addition
 - substitution
 - Free radical
 - combination
- Saponification is carried out by
 - oxidation
 - alkaline hydrolysis
 - polymerisation
 - Free radical formation
- Aspirin is chemically named as
 - Salicylic acid
 - acetyl salicylic acid
 - chloroxylenol
 - thymol
- Find odd one out from the following
 - dettol
 - chloroxylenol
 - paracetamol
 - trichlorophenol
- Arsenic based antibiotic is
 - Azodye
 - prontosil
 - salvarsan
 - sulphapyridine
- The chemical used to slow down the browning action of cut fruit is
 - SO_3
 - SO_2
 - H_2SO_4
 - Na_2CO_3
- The chemical is responsible for the rancid flavour of fats is
 - Butyric acid
 - Glycerol
 - Protein
 - Saturated fat

- Health benefits are obtained by consumption of
 - Saturated fats
 - trans fats
 - mono unsaturated fats
 - all of these

2. Explain the following :

- Cooking makes food easy to digest.
- On cutting some fruits and vegetable turn brown.
- Vitamin E is added to packed edible oil.
- Browning of cut apple can be prolonged by applying lemon juice.
- A diluted solution (4.8 % w/v) of 2,4,6-trichlorophenol is employed as antiseptic.
- Turmeric powder can be used as antiseptic.

3. Identify the functional groups in the following molecule :

- Aspirin

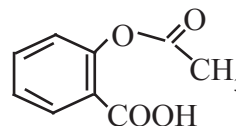

B. Paracetamol

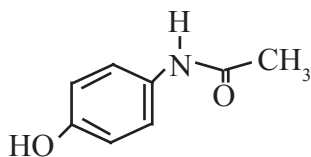

C. Penicillin

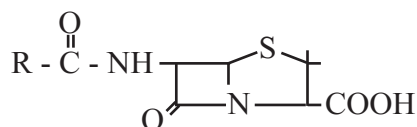

D. Chloramphenicol

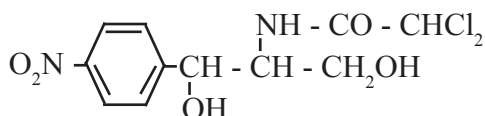

E. Sulphanilamide

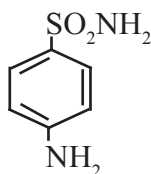

F. Glycerin

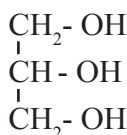

4. Give two differences between the following

- A. Disinfectant and antiseptic
- B. Soap and synthetic detergent
- C. Saturated and unsaturated fats
- D. Rice flour and cooked rice

5. Match the pairs.

A group

- A. Paracetamol
- B. Chloramphenicol

C. BHT

D. Sodium stearate

B group

a. Antibiotic

b. Synthetic detergent

c. Soap

d. Antioxidant

e. Analgesic

6. Name two drugs which reduce body pain.

7. Explain with examples

- A. Antiseptics
- B. Disinfectant
- C. Cationic detergents

D. Anionic detergents

E. Non-ionic detergents

8. Explain : mechanism of cleansing Action of soap with flow chart.

9. What is meant by broad spectrum antibiotic and narrow spectrum antibiotics?

10. Answer in one sentence

- A. Name the painkiller obtained from acetylation of salicylic acid.
- B. Name the class of drug often called as painkiller.
- C. Who discovered penicillin?
- D. Draw the structure of chloroxylenol and salvarsan.
- E. Write molecular formula of Butylated hydroxy toluene.
- F. What is the tincture of iodine ?
- G. Draw the structure of BHT.
- I. Write a chemical equation for saponification.
- J. Write the molecular formula and name of

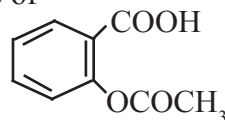

11. Answer the following

- A. Write two examples of the following.
 - a. Analgesics
 - c. Antiseptics
 - d. Antibiotics
 - e. Disinfectant
- B. What do you understand by antioxidant ?



Activity :

Collect information about different chemical compounds as per their applications in day-to-day life.

Modern Periodic Table

Periods	1	2	3	4	5	6	7	8	9	10	11	12	13	14	15	16	17	18	
1	1 H Hydrogen 1.008																	2 He Helium 4.003	
2	3 Li Lithium 6.941	4 Be Beryllium 9.012															9 F Fluorine 18.998	10 Ne Neon 20.180	
3	11 Na Sodium 22.990	12 Mg Magnesium 24.305															17 Cl Chlorine 35.453	18 Ar Argon 39.948	
4	19 K Potassium 39.098	20 Ca Calcium 40.078	21 Sc Scandium 44.956	22 Ti Titanium 47.867	23 V Vanadium 50.942	24 Cr Chromium 51.996	25 Mn Manganese 54.938	26 Fe Iron 55.845	27 Co Cobalt 58.933	28 Ni Nickel 58.693	29 Cu Copper 63.546	30 Zn Zinc 65.38		31 Ga Gallium 69.723	32 Ge Germanium 72.631	33 As Arsenic 74.922	34 Se Selenium 78.971	35 Br Bromine 79.904	36 Kr Krypton 83.798
5	37 Rb Rubidium 85.468	38 Sr Strontium 87.62	39 Y Yttrium 88.906	40 Zr Zirconium 91.224	41 Nb Niobium 92.906	42 Mo Molybdenum 95.95	43 Tc Technetium 98.907	44 Ru Ruthenium 101.07	45 Rh Rhodium 102.906	46 Pd Palladium 106.42	47 Ag Silver 107.868	48 Cd Cadmium 112.414		49 In Indium 114.818	50 Sn Tin 118.711	51 Sb Antimony 121.760	52 Te Tellurium 127.6	53 I Iodine 126.904	54 Xe Xenon 131.293
6	55 Cs Cesium 132.905	56 Ba Barium 137.328	57-71 La Lanthanoids	72 Hf Hafnium 178.49	73 Ta Tantalum 180.948	74 W Tungsten 183.84	75 Re Rhenium 186.207	76 Os Osmium 192.23	77 Ir Iridium 192.217	78 Pt Platinum 195.085	79 Au Gold 196.967	80 Hg Mercury 200.592		81 Tl Thallium 204.383	82 Pb Lead 207.2	83 Bi Bismuth 208.980	84 Po Polonium 209	85 At Astatine 209	86 Rn Radon 222
7	87 Fr Francium 223	88 Ra Radium 226	89-103 Ac Actinoids	104 Rf Rutherfordium (261)	105 Db Dubnium (262)	106 Sg Seaborgium (263)	107 Bh Bohrium (264)	108 Hs Hassium (265)	109 Mt Meitnerium (268)	110 Ds Darmstadtium (281)	111 Rg Roentgenium (280)	112 Cn Copernicium (285)		113 Nh Nihonium (286)	114 Fl Flerovium (289)	115 Mc Moscovium (289)	116 Lv Livermorium (293)	117 Ts Tennessine (294)	118 Og Oganesson (294)

Z
Symbol
Name
Atomic Mass

- Alkali metal
- Alkaline Earth
- Transition Metal
- Basic Metal
- Metalloid
- Nonmetal
- Halogen
- Noble Gas
- Lanthanoid
- Actinoid

Notes

A series of horizontal dotted lines for writing notes.



**Maharashtra State Bureau of Textbook Production and
Curriculum Research, Pune**

रसायनशास्त्र - इयत्ता ११ वी (इंग्रजी माध्यम)

₹ 154.00