

JEE March 2021 16th to 18th Mar

Application No	
Candidate Name	
Roll No.	
Test Date	17/03/2021
Test Time	9:00 AM - 12:00 PM
Subject	B TECH

Section : Physics Section A

Q.1 A polyatomic ideal gas has 24 vibrational modes. What is the value of γ ?

- Options
1. 10.3
 2. 1.03
 3. 1.30
 4. 1.37

Question Type : **MCQ**

Question ID : **8643513338**

Option 1 ID : **86435110019**

Option 2 ID : **86435110021**

Option 3 ID : **86435110020**

Option 4 ID : **86435110022**

Status : **Not Answered**

Chosen Option : --

Q.2

The output of the given combination gates represents :

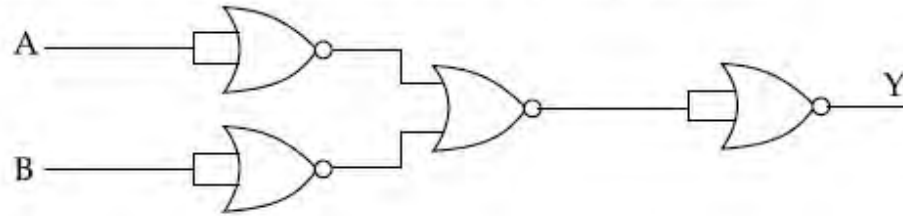

Options 1. NOR Gate

2. XOR Gate

3. NAND Gate

4. AND Gate

Question Type : MCQ

Question ID : 8643513347

Option 1 ID : 86435110056

Option 2 ID : 86435110058

Option 3 ID : 86435110057

Option 4 ID : 86435110055

Status : Answered

Chosen Option : 3

- Q.3** A mass M hangs on a massless rod of length l which rotates at a constant angular frequency. The mass M moves with steady speed in a circular path of constant radius. Assume that the system is in steady circular motion with constant angular velocity ω . The angular momentum of M about point A is L_A which lies in the positive z direction and the angular momentum of M about point B is L_B . The correct statement for this system is :

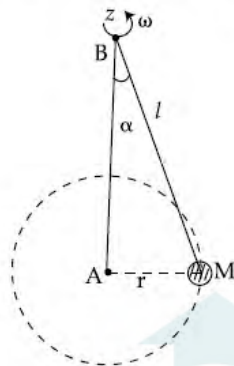

- Options**
1. L_B is constant in direction with varying magnitude
 2. L_B is constant, both in magnitude and direction
 3. L_A is constant, both in magnitude and direction
 4. L_A and L_B are both constant in magnitude and direction

Question Type : **MCQ**

Question ID : **8643513336**

Option 1 ID : **86435110014**

Option 2 ID : **86435110013**

Option 3 ID : **86435110012**

Option 4 ID : **86435110011**

Status : **Not Answered**

Chosen Option : --

Q.4 Which level of the single ionized carbon has the same energy as the ground state energy of hydrogen atom ?

- Options**
1. 8
 2. 1
 3. 6
 4. 4

Question Type : **MCQ**

Question ID : **8643513344**

Option 1 ID : **86435110046**

Option 2 ID : **86435110043**

Option 3 ID : **86435110045**

Option 4 ID : **86435110044**

Status : **Answered**

Chosen Option : **3**



shiksha

Q.5 If an electron is moving in the n^{th} orbit of the hydrogen atom, then its velocity (v_n) for the n^{th} orbit is given as :

Options

1. $v_n \propto \frac{1}{n^2}$
2. $v_n \propto n^2$
3. $v_n \propto n$
4. $v_n \propto \frac{1}{n}$

Question Type : **MCQ**

Question ID : **8643513350**

Option 1 ID : **86435110069**

Option 2 ID : **86435110067**

Option 3 ID : **86435110068**

Option 4 ID : **86435110070**

Status : **Not Answered**

Chosen Option : --



Q.6 An electron of mass m and a photon have same energy E . The ratio of wavelength of electron to that of photon is : (c being the velocity of light)

Options

1. $c (2mE)^{1/2}$

2. $\left(\frac{E}{2m}\right)^{1/2}$

3. $\frac{1}{c} \left(\frac{2m}{E}\right)^{1/2}$

4. $\frac{1}{c} \left(\frac{E}{2m}\right)^{1/2}$

Question Type : **MCQ**

Question ID : **8643513348**

Option 1 ID : **86435110060**

Option 2 ID : **86435110059**

Option 3 ID : **86435110061**

Option 4 ID : **86435110062**

Status : **Not Answered**

Chosen Option : --

Q.7 For what value of displacement the kinetic energy and potential energy of a simple harmonic oscillation become equal ?

Options

1. $x = 0$

2. $x = \pm A$

3. $x = \pm \frac{A}{\sqrt{2}}$

4. $x = \frac{A}{2}$

Question Type : **MCQ**

Question ID : **8643513346**

Option 1 ID : **86435110052**

Option 2 ID : **86435110051**

Option 3 ID : **86435110053**

Option 4 ID : **86435110054**

Status : **Not Answered**

Chosen Option : --



shiksha

Q.8 The vernier scale used for measurement has a positive zero error of 0.2 mm. If while taking a measurement it was noted that '0' on the vernier scale lies between 8.5 cm and 8.6 cm, vernier coincidence is 6, then the correct value of measurement is _____ cm.
(least count = 0.01 cm)

- Options**
1. 8.56 cm
 2. 8.36 cm
 3. 8.54 cm
 4. 8.58 cm

Question Type : **MCQ**

Question ID : **8643513349**

Option 1 ID : **86435110064**

Option 2 ID : **86435110066**

Option 3 ID : **86435110065**

Option 4 ID : **86435110063**

Status : **Answered**

Chosen Option : **4**



shiksha

Q.9 A boy is rolling a 0.5 kg ball on the frictionless floor with the speed of 20 ms^{-1} . The ball gets deflected by an obstacle on the way. After deflection it moves with 5% of its initial kinetic energy. What is the speed of the ball now ?

- Options
1. 19.0 ms^{-1}
 2. 14.41 ms^{-1}
 3. 4.47 ms^{-1}
 4. 1.00 ms^{-1}

Question Type : **MCQ**

Question ID : **8643513342**

Option 1 ID : **86435110038**

Option 2 ID : **86435110037**

Option 3 ID : **86435110036**

Option 4 ID : **86435110035**

Status : **Answered**

Chosen Option : **3**



shiksha

Q.10 The thickness at the centre of a plano convex lens is 3 mm and the diameter is 6 cm. If the speed of light in the material of the lens is $2 \times 10^8 \text{ ms}^{-1}$. The focal length of the lens is _____.

- Options**
1. 1.5 cm
 2. 0.30 cm
 3. 30 cm
 4. 15 cm

Question Type : **MCQ**

Question ID : **8643513343**

Option 1 ID : **86435110041**

Option 2 ID : **86435110042**

Option 3 ID : **86435110039**

Option 4 ID : **86435110040**

Status : **Not Answered**

Chosen Option : --



shiksha

Q.11 When two soap bubbles of radii a and b ($b > a$) coalesce, the radius of curvature of common surface is :

Options

1. $\frac{ab}{a+b}$

2. $\frac{ab}{b-a}$

3. $\frac{a+b}{ab}$

4. $\frac{b-a}{ab}$

Question Type : **MCQ**

Question ID : **8643513339**

Option 1 ID : **86435110024**

Option 2 ID : **86435110023**

Option 3 ID : **86435110026**

Option 4 ID : **86435110025**

Status : **Answered**

Chosen Option : **1**



Q.12 A car accelerates from rest at a constant rate α for some time after which it decelerates at a constant rate β to come to rest. If the total time elapsed is t seconds, the total distance travelled is :

Options

1. $\frac{4 \alpha \beta}{(\alpha + \beta)} t^2$

2. $\frac{2 \alpha \beta}{(\alpha + \beta)} t^2$

3. $\frac{\alpha \beta}{4 (\alpha + \beta)} t^2$

4. $\frac{\alpha \beta}{2(\alpha + \beta)} t^2$

Question Type : **MCQ**

Question ID : **8643513331**

Option 1 ID : **8643519993**

Option 2 ID : **8643519991**

Option 3 ID : **8643519994**

Option 4 ID : **8643519992**

Status : **Not Answered**

Chosen Option : --



Q.13 A solenoid of 1000 turns per metre has a core with relative permeability 500. Insulated windings of the solenoid carry an electric current of 5 A. The magnetic flux density produced by the solenoid is : (permeability of free space = $4\pi \times 10^{-7}$ H/m)

- Options
1. $2 \times 10^{-3}\pi$ T
 2. π T
 3. $10^{-4}\pi$ T
 4. $\frac{\pi}{5}$ T

Question Type : **MCQ**

Question ID : **8643513334**

Option 1 ID : **86435110004**

Option 2 ID : **86435110006**

Option 3 ID : **86435110003**

Option 4 ID : **86435110005**

Status : **Answered**

Chosen Option : **2**



shiksha

Q.14 A triangular plate is shown. A force $\vec{F} = 4\hat{i} - 3\hat{j}$ is applied at point P. The torque at point

P with respect to point 'O' and 'Q' are :

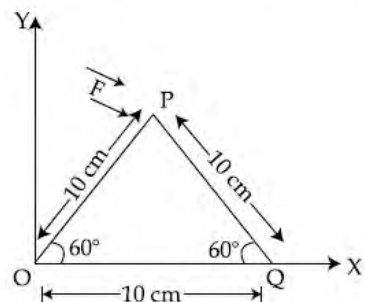

- Options**
1. $-15 + 20\sqrt{3}, 15 + 20\sqrt{3}$
 2. $-15 - 20\sqrt{3}, 15 - 20\sqrt{3}$
 3. $15 + 20\sqrt{3}, 15 - 20\sqrt{3}$
 4. $15 - 20\sqrt{3}, 15 + 20\sqrt{3}$

Question Type : **MCQ**

Question ID : **8643513340**

Option 1 ID : **86435110030**

Option 2 ID : **86435110027**

Option 3 ID : **86435110028**

Option 4 ID : **86435110029**

Status : **Answered**

Chosen Option : **1**

Q.15 An AC current is given by $I = I_1 \sin \omega t + I_2 \cos \omega t$. A hot wire ammeter will give a reading :

Options

1. $\frac{I_1 + I_2}{2\sqrt{2}}$

2. $\sqrt{\frac{I_1^2 + I_2^2}{2}}$

3. $\sqrt{\frac{I_1^2 - I_2^2}{2}}$

4. $\frac{I_1 + I_2}{\sqrt{2}}$

Question Type : **MCQ**

Question ID : **8643513337**

Option 1 ID : **86435110016**

Option 2 ID : **86435110017**

Option 3 ID : **86435110018**

Option 4 ID : **86435110015**

Status : **Not Answered**

Chosen Option : --



shiksha

- Q.16** A modern grand - prix racing car of mass m is travelling on a flat track in a circular arc of radius R with a speed v . If the coefficient of static friction between the tyres and the track is μ_s , then the magnitude of negative lift F_L acting downwards on the car is : (Assume forces on the four tyres are identical and g = acceleration due to gravity)

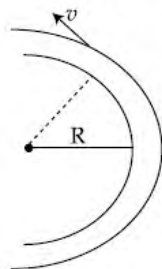

Options

1. $m \left(\frac{v^2}{\mu_s R} - g \right)$

2. $- m \left(g + \frac{v^2}{\mu_s R} \right)$

3. $m \left(\frac{v^2}{\mu_s R} + g \right)$

4. $m \left(g - \frac{v^2}{\mu_s R} \right)$

shiksha

Question Type : **MCQ**

Question ID : **8643513332**

Option 1 ID : **8643519997**

Option 2 ID : **8643519998**

Option 3 ID : **8643519995**

Option 4 ID : **8643519996**

Status : **Not Answered**

Chosen Option : --

Q.17 A Carnot's engine working between 400 K and 800 K has a work output of 1200 J per cycle.
The amount of heat energy supplied to the engine from the source in each cycle is :

- Options**
1. 1600 J
 2. 2400 J
 3. 1800 J
 4. 3200 J

Question Type : **MCQ**

Question ID : **8643513333**

Option 1 ID : **86435110000**

Option 2 ID : **8643519999**

Option 3 ID : **86435110002**

Option 4 ID : **86435110001**

Status : **Answered**

Chosen Option : **2**



shiksha

Q.18 Two identical metal wires of thermal conductivities K_1 and K_2 respectively are connected in series. The effective thermal conductivity of the combination is :

Options

1. $\frac{K_1 + K_2}{2K_1 K_2}$

2. $\frac{2K_1 K_2}{K_1 + K_2}$

3. $\frac{K_1 K_2}{K_1 + K_2}$

4. $\frac{K_1 + K_2}{K_1 K_2}$

Question Type : **MCQ**

Question ID : **8643513341**

Option 1 ID : **86435110033**

Option 2 ID : **86435110032**

Option 3 ID : **86435110031**

Option 4 ID : **86435110034**

Status : **Answered**

Chosen Option : **3**

Q.19 Two ideal polyatomic gases at temperatures T_1 and T_2 are mixed so that there is no loss of energy. If F_1 and F_2 , m_1 and m_2 , n_1 and n_2 be the degrees of freedom, masses, number of molecules of the first and second gas respectively, the temperature of mixture of these two gases is :

Options

1.
$$\frac{n_1 F_1 T_1 + n_2 F_2 T_2}{n_1 F_1 + n_2 F_2}$$

2.
$$\frac{n_1 F_1 T_1 + n_2 F_2 T_2}{F_1 + F_2}$$

3.
$$\frac{n_1 F_1 T_1 + n_2 F_2 T_2}{n_1 + n_2}$$

4.
$$\frac{n_1 T_1 + n_2 T_2}{n_1 + n_2}$$

Question Type : **MCQ**

Question ID : **8643513345**

Option 1 ID : **86435110049**

Option 2 ID : **86435110048**

Option 3 ID : **86435110047**

Option 4 ID : **86435110050**

Status : **Answered**

Chosen Option : **3**



shiksha

Q.20 A current of 10 A exists in a wire of cross-sectional area of 5 mm^2 with a drift velocity of $2 \times 10^{-3} \text{ ms}^{-1}$. The number of free electrons in each cubic meter of the wire is _____.

- Options**
1. 2×10^6
 2. 625×10^{25}
 3. 2×10^{25}
 4. 1×10^{23}

Question Type : **MCQ**

Question ID : **8643513335**

Option 1 ID : **86435110007**

Option 2 ID : **86435110009**

Option 3 ID : **86435110010**

Option 4 ID : **86435110008**

Status : **Answered**

Chosen Option : **2**

Section : **Physics Section B**

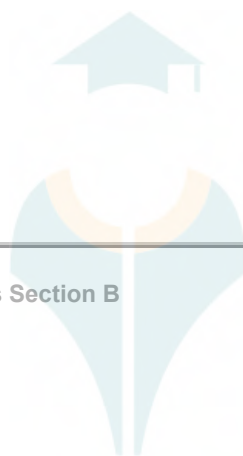

shiksha

Q.1 Consider two identical springs each of spring constant k and negligible mass compared to the mass M as shown. Fig. 1 shows one of them and Fig. 2 shows their series combination.

The ratios of time period of oscillation of the two SHM is $T_b/T_a = \sqrt{x}$, where value of x is

_____. (Round off to the Nearest Integer)

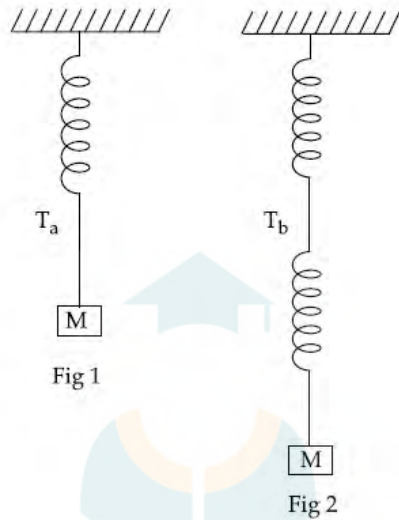

Given 2
Answer :

Question Type : SA

Question ID : 8643513358

Status : Answered

Q.2 The following bodies,

- (1) a ring
- (2) a disc
- (3) a solid cylinder
- (4) a solid sphere,

of same mass ' m ' and radius ' R ' are allowed to roll down without slipping simultaneously from the top of the inclined plane. The body which will reach first at the bottom of the inclined plane is _____.

[Mark the body as per their respective numbering given in the question]

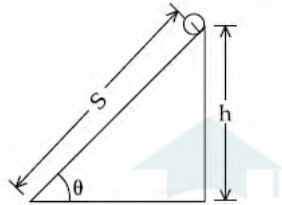

Given 4

Answer :

Question Type : SA

Question ID : 8643513359

Status : Answered

Q.3 The equivalent resistance of series combination of two resistors is ' s '. When they are connected in parallel, the equivalent resistance is ' p '. If $s = np$, then the minimum value for n is _____. (Round off to the Nearest Integer)

Given 3

Answer :

Question Type : SA

Question ID : 8643513354

Status : Answered

- Q.4** If 2.5×10^{-6} N average force is exerted by a light wave on a non - reflecting surface of 30 cm^2 area during 40 minutes of time span, the energy flux of light just before it falls on the surface is _____ W/cm^2 . (Round off to the Nearest Integer)
(Assume complete absorption and normal incidence conditions are there)

Given 0
Answer :

Question Type : **SA**

Question ID : **8643513352**

Status : **Answered**

- Q.5** Four identical rectangular plates with length, $l = 2 \text{ cm}$ and breadth, $b = \frac{3}{2} \text{ cm}$ are arranged as shown in figure. The equivalent capacitance between A and C is $\frac{x\epsilon_0}{d}$. The value of x is _____ . (Round off to the Nearest Integer)

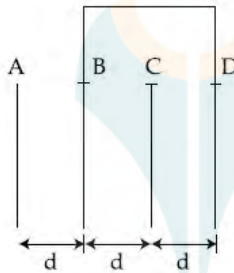

Given --
Answer :

Question Type : **SA**

Question ID : **8643513353**

Status : **Not Answered**

Q.6 The angular speed of truck wheel is increased from 900 rpm to 2460 rpm in 26 seconds. The number of revolutions by the truck engine during this time is _____.
(Assuming the acceleration to be uniform).

Given --
Answer :

Question Type : **SA**
Question ID : **8643513357**
Status : **Not Answered**

Q.7 A parallel plate capacitor whose capacitance C is 14 pF is charged by a battery to a potential difference $V = 12$ V between its plates. The charging battery is now disconnected and a porcelain plate with $k=7$ is inserted between the plates, then the plate would oscillate back and forth between the plates with a constant mechanical energy of _____ pJ.
(Assume no friction)

Given --
Answer :

Question Type : **SA**
Question ID : **8643513355**
Status : **Not Answered**

Q.8 The radius in kilometer to which the present radius of earth ($R = 6400$ km) to be compressed so that the escape velocity is increased 10 times is _____.

Given --
Answer :

Question Type : **SA**
Question ID : **8643513356**
Status : **Not Answered**

Q.9 For VHF signal broadcasting, _____ km^2 of maximum service area will be covered by an antenna tower of height 30 m, if the receiving antenna is placed at ground. Let radius of the earth be 6400 km. (Round off to the Nearest Integer) (Take π as 3.14)

Given --
Answer :

Question Type : SA

Question ID : 8643513351

Status : Not Answered

Q.10 Two blocks ($m=0.5$ kg and $M=4.5$ kg) are arranged on a horizontal frictionless table as shown in figure. The coefficient of static friction between the two blocks is $\frac{3}{7}$. Then the maximum horizontal force that can be applied on the larger block so that the blocks move together is _____ N. (Round off to the Nearest Integer) [Take g as 9.8 ms^{-2}]

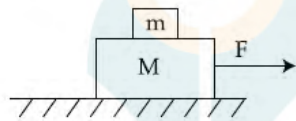

Given --
Answer :

Question Type : SA

Question ID : 8643513360

Status : Not Answered

Section : Chemistry Section A

Q.1 A central atom in a molecule has two lone pairs of electrons and forms three single bonds.
The shape of this molecule is :

- Options**
1. planar triangular
 2. trigonal pyramidal
 3. see-saw
 4. T-shaped

Question Type : **MCQ**

Question ID : **8643513361**

Option 1 ID : **86435110081**

Option 2 ID : **86435110084**

Option 3 ID : **86435110083**

Option 4 ID : **86435110082**

Status : **Answered**

Chosen Option : **2**



shiksha

Q.2 What is the spin-only magnetic moment value (BM) of a divalent metal ion with atomic number 25, in its aqueous solution ?

- Options**
1. 5.26
 2. 5.0
 3. 5.92
 4. zero

Question Type : **MCQ**

Question ID : **8643513368**

Option 1 ID : **86435110110**

Option 2 ID : **86435110109**

Option 3 ID : **86435110111**

Option 4 ID : **86435110112**

Status : **Answered**

Chosen Option : **3**



shiksha

Q.3 Given below are two statements :

Statement I : Retardation factor (R_f) can be measured in meter/centimeter.

Statement II : R_f value of a compound remains constant in all solvents.

Choose the most appropriate answer from the options given below :

- Options
1. Both statement I and statement II are true
 2. Statement I is false but statement II is true
 3. Both statement I and statement II are false
 4. Statement I is true but statement II is false

Question Type : **MCQ**

Question ID : **8643513371**

Option 1 ID : **86435110121**

Option 2 ID : **86435110124**

Option 3 ID : **86435110122**

Option 4 ID : **86435110123**

Status : **Not Answered**

Chosen Option : --



shiksha

Q.4 The **INCORRECT** statement(s) about heavy water is (are)

- (A) used as a moderator in nuclear reactor
- (B) obtained as a by-product in fertilizer industry
- (C) used for the study of reaction mechanism
- (D) has a higher dielectric constant than water

Choose the correct answer from the options given below :

Options 1. (B) and (D) only

2. (B) only

3. (D) only

4. (C) only



Question Type : **MCQ**

Question ID : **8643513365**

Option 1 ID : **86435110100**

Option 2 ID : **86435110098**

Option 3 ID : **86435110099**

Option 4 ID : **86435110097**

Status : **Answered**

Chosen Option : **1**

Q.5 A colloidal system consisting of a gas dispersed in a solid is called a/an :

- Options**
1. gel
 2. aerosol
 3. solid sol
 4. foam

Question Type : **MCQ**

Question ID : **8643513362**

Option 1 ID : **86435110088**

Option 2 ID : **86435110085**

Option 3 ID : **86435110086**

Option 4 ID : **86435110087**

Status : **Answered**

Chosen Option : **2**

Q.6 Reducing smog is a mixture of :

- Options**
1. Smoke, fog and O_3
 2. Smoke, fog and N_2O_3
 3. Smoke, fog and $CH_2=CH-CHO$
 4. Smoke, fog and SO_2

Question Type : **MCQ**

Question ID : **8643513370**

Option 1 ID : **86435110117**

Option 2 ID : **86435110119**

Option 3 ID : **86435110120**

Option 4 ID : **86435110118**

Status : **Answered**

Chosen Option : **4**

Q.7 Given below are two statements :

Statement I : Potassium permanganate on heating at 573 K forms potassium manganate.

Statement II : Both potassium permanganate and potassium manganate are tetrahedral and paramagnetic in nature.

In the light of the above statements, choose the most appropriate answer from the options given below :

- Options**
1. Both statement I and statement II are true
 2. Both statement I and statement II are false
 3. Statement I is false but statement II is true
 4. Statement I is true but statement II is false



Question Type : **MCQ**

Question ID : **8643513369**

Option 1 ID : **86435110114**

Option 2 ID : **86435110113**

Option 3 ID : **86435110116**

Option 4 ID : **86435110115**

Status : **Not Answered**

Chosen Option : --

Q.8 With respect to drug-enzyme interaction, identify the wrong statement.

- Options**
1. Allosteric inhibitor competes with the enzyme's active site
 2. Non-Competitive inhibitor binds to the allosteric site
 3. Allosteric inhibitor changes the enzyme's active site
 4. Competitive inhibitor binds to the enzyme's active site

Question Type : **MCQ**

Question ID : **8643513379**

Option 1 ID : **86435110155**

Option 2 ID : **86435110156**

Option 3 ID : **86435110154**

Option 4 ID : **86435110153**

Status : **Not Answered**

Chosen Option : --

Q.9 The absolute value of the electron gain enthalpy of halogens satisfies :

- Options**
1. $F > Cl > Br > I$
 2. $Cl > Br > F > I$
 3. $Cl > F > Br > I$
 4. $I > Br > Cl > F$

Question Type : **MCQ**

Question ID : **8643513363**

Option 1 ID : **86435110089**

Option 2 ID : **86435110091**

Option 3 ID : **86435110090**

Option 4 ID : **86435110092**

Status : **Answered**

Chosen Option : **3**

Q.10

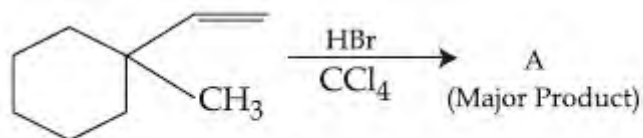

Product "A" in the above chemical reaction is :

Options

-
-
-
-

Question Type : MCQ

Question ID : 8643513373

Option 1 ID : 86435110131

Option 2 ID : 86435110129

Option 3 ID : 86435110130

Option 4 ID : 86435110132

Status : Answered

Chosen Option : 1

Q.11 Which of the following is an aromatic compound ?

Options

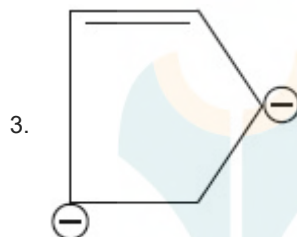
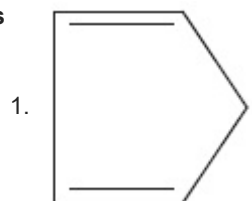

Question Type : MCQ

Question ID : 8643513372

Option 1 ID : 86435110125

Option 2 ID : 86435110127

Option 3 ID : 86435110128

Option 4 ID : 86435110126

Status : Answered

Chosen Option : 4

Q.12 The point of intersection and sudden increase in the slope, in the diagram given below, respectively, indicates :

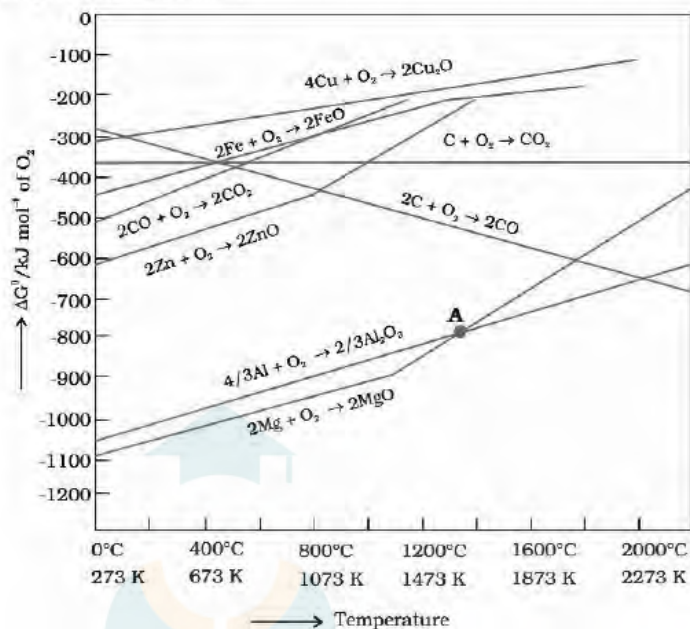

- Options**
1. $\Delta G > 0$ and decomposition of the metal oxide
 2. $\Delta G = 0$ and melting or boiling point of the metal oxide
 3. $\Delta G < 0$ and decomposition of the metal oxide
 4. $\Delta G = 0$ and reduction of the metal oxide

Question Type : **MCQ**

Question ID : **8643513364**

Option 1 ID : **86435110094**

Option 2 ID : **86435110095**

Option 3 ID : **86435110093**

Option 4 ID : **86435110096**

Status : **Answered**

Chosen Option : **4**

Q.13 Mesityl oxide is a common name of :

- Options**
1. 4-Methyl pent-3-en-2-one
 2. 2,4-Dimethyl pentan-3-one
 3. 2-Methyl cyclohexanone
 4. 3-Methyl cyclohexane carbaldehyde

Question Type : **MCQ**

Question ID : **8643513375**

Option 1 ID : **86435110137**

Option 2 ID : **86435110138**

Option 3 ID : **86435110139**

Option 4 ID : **86435110140**

Status : **Not Answered**

Chosen Option : --



shiksha

Q.14 Which of the following reaction is an example of ammonolysis ?

Options

1. $\text{C}_6\text{H}_5\text{CH}_2\text{CN} \xrightarrow{[\text{H}]} \text{C}_6\text{H}_5\text{CH}_2\text{CH}_2\text{NH}_2$
2. $\text{C}_6\text{H}_5\text{NH}_2 \xrightarrow{\text{HCl}} \text{C}_6\text{H}_5\text{NH}_3^+\text{Cl}^-$
3. $\text{C}_6\text{H}_5\text{COCl} + \text{C}_6\text{H}_5\text{NH}_2 \longrightarrow \text{C}_6\text{H}_5\text{CONHC}_6\text{H}_5$
4. $\text{C}_6\text{H}_5\text{CH}_2\text{Cl} + \text{NH}_3 \longrightarrow \text{C}_6\text{H}_5\text{CH}_2\text{NH}_2$

Question Type : **MCQ**

Question ID : **8643513378**

Option 1 ID : **86435110150**

Option 2 ID : **86435110152**

Option 3 ID : **86435110149**

Option 4 ID : **86435110151**

Status : **Answered**

Chosen Option : **4**



shiksha

Q.15 The correct order of conductivity of ions in water is :

- Options**
1. $\text{Na}^+ > \text{K}^+ > \text{Rb}^+ > \text{Cs}^+$
 2. $\text{Cs}^+ > \text{Rb}^+ > \text{K}^+ > \text{Na}^+$
 3. $\text{K}^+ > \text{Na}^+ > \text{Cs}^+ > \text{Rb}^+$
 4. $\text{Rb}^+ > \text{Na}^+ > \text{K}^+ > \text{Li}^+$

Question Type : **MCQ**

Question ID : **8643513366**

Option 1 ID : **86435110102**

Option 2 ID : **86435110101**

Option 3 ID : **86435110103**

Option 4 ID : **86435110104**

Status : **Not Answered**

Chosen Option : --



shiksha

Q.16 Which of the following is correct structure of tyrosine ?

Options

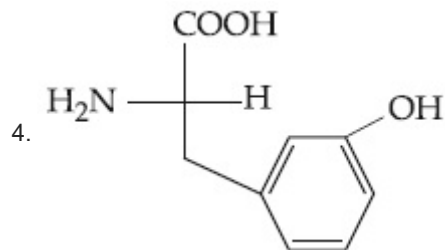
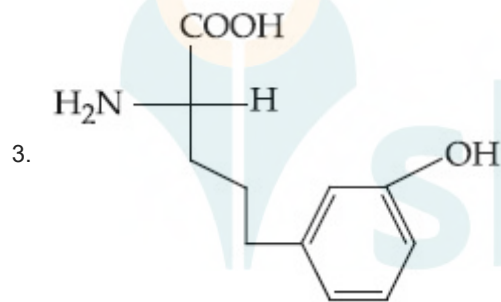
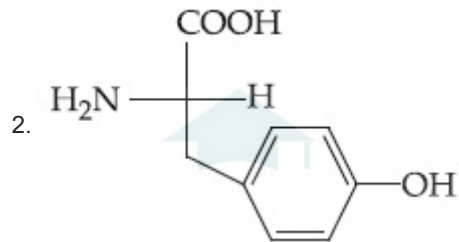
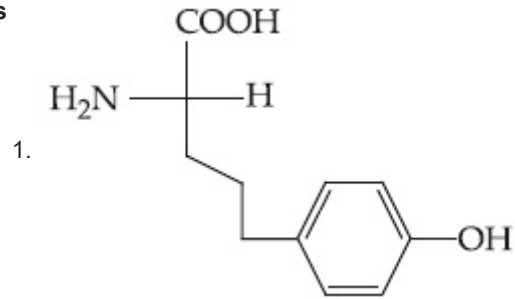

Question Type : **MCQ**

Question ID : **8643513380**

Option 1 ID : **86435110160**

Option 2 ID : **86435110159**Option 3 ID : **86435110158**Option 4 ID : **86435110157**Status : **Not Answered**

Chosen Option : --

Q.17

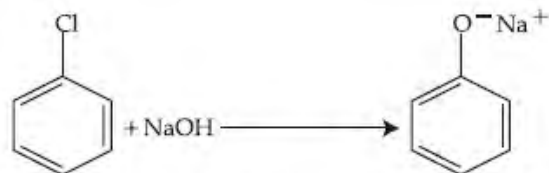

The above reaction requires which of the following reaction conditions ?

- Options
1. 623 K, 300 atm
 2. 573 K, Cu, 300 atm
 3. 623 K, Cu, 300 atm
 4. 573 K, 300 atm

Question Type : **MCQ**Question ID : **8643513374**Option 1 ID : **86435110135**Option 2 ID : **86435110134**Option 3 ID : **86435110133**Option 4 ID : **86435110136**Status : **Answered**Chosen Option : **3**

Q.18 Hoffmann bromamide degradation of benzamide gives product A, which upon heating with CHCl_3 and NaOH gives product B. The structures of A and B are :

Options

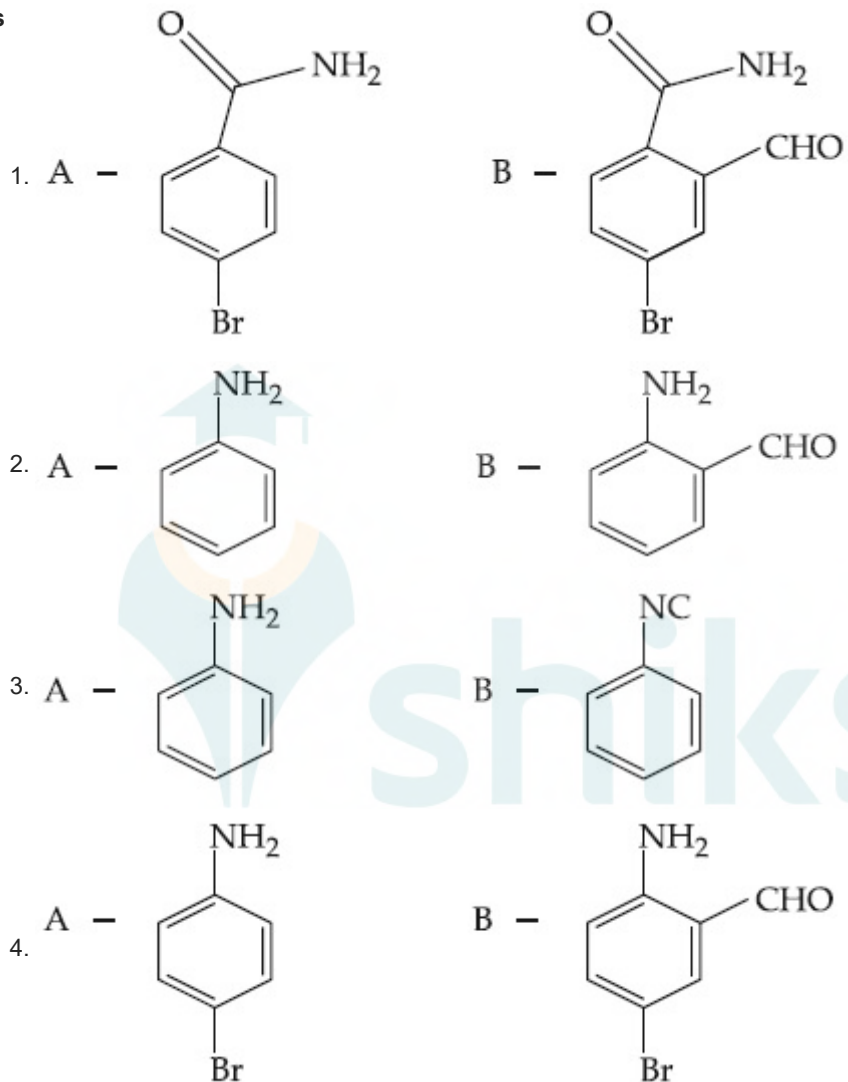

Question Type : **MCQ**

Question ID : **8643513376**

Option 1 ID : **86435110141**

Option 2 ID : **86435110144**

Option 3 ID : **86435110142**Option 4 ID : **86435110143**Status : **Answered**Chosen Option : **3**

Q.19 Which of the following compound **CANNOT** act as a Lewis base ?

Options

1. SF_4 2. PCl_5 3. ClF_3 4. NF_3 Question Type : **MCQ**Question ID : **8643513367**Option 1 ID : **86435110108**Option 2 ID : **86435110106**Option 3 ID : **86435110105**Option 4 ID : **86435110107**Status : **Answered**Chosen Option : **2**

Q.20

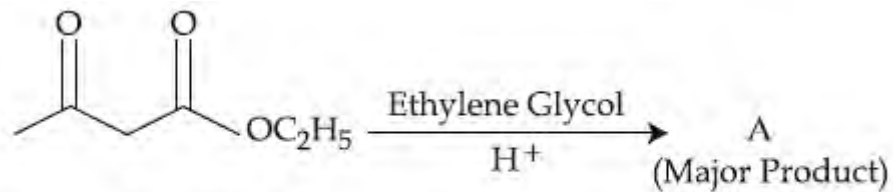

The product "A" in the above reaction is :

Options

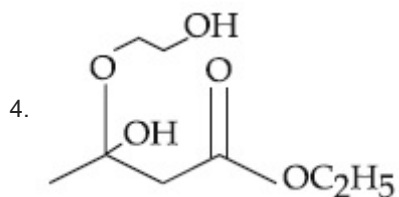
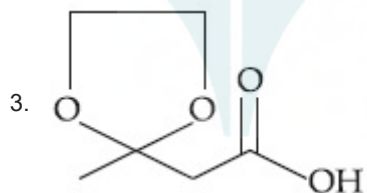
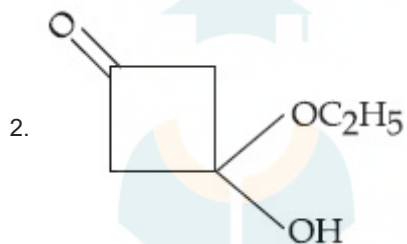
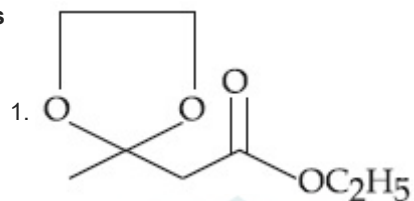

Question Type : MCQ

Question ID : 8643513377

Option 1 ID : 86435110148

Option 2 ID : 86435110147

Option 3 ID : **86435110146**
Option 4 ID : **86435110145**
Status : **Answered**
Chosen Option : 1

Section : **Chemistry Section B**

Q.1 The pressure exerted by a non-reactive gaseous mixture of 6.4 g of methane and 8.8 g of carbon dioxide in a 10 L vessel at 27°C is _____ kPa.
(Round off to the Nearest Integer).
[Assume gases are ideal, $R = 8.314 \text{ J mol}^{-1} \text{ K}^{-1}$
Atomic masses : C : 12.0 u, H : 1.0 u, O : 16.0 u]

Given **1496**
Answer :

Question Type : **SA**
Question ID : **8643513382**
Status : **Answered**

Q.2 For a certain first order reaction 32% of the reactant is left after 570 s. The rate constant of this reaction is _____ $\times 10^{-3} \text{ s}^{-1}$. (Round off to the Nearest Integer).
[Given : $\log_{10} 2 = 0.301$, $\ln 10 = 2.303$]

Given **13**
Answer :

Question Type : **SA**
Question ID : **8643513388**
Status : **Answered**

Q.3 15 mL of aqueous solution of Fe^{2+} in acidic medium completely reacted with 20 mL of 0.03 M aqueous $\text{Cr}_2\text{O}_7^{2-}$. The molarity of the Fe^{2+} solution is _____ $\times 10^{-2}$ M. (Round off to the Nearest Integer).

Given 4
Answer :

Question Type : **SA**
Question ID : **8643513387**
Status : **Answered**

Q.4 The oxygen dissolved in water exerts a partial pressure of 20 kPa in the vapour above water. The molar solubility of oxygen in water is _____ $\times 10^{-5}$ mol dm^{-3} . (Round off to the Nearest Integer).
[Given : Henry's law constant = $K_H = 8.0 \times 10^4$ kPa for O_2 .
Density of water with dissolved oxygen = 1.0 kg dm^{-3}]

Given --
Answer :

Question Type : **SA**
Question ID : **8643513385**
Status : **Not Answered**



shiksha

Q.5

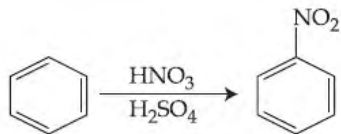

In the above reaction, 3.9 g of benzene on nitration gives 4.92 g of nitrobenzene. The percentage yield of nitrobenzene in the above reaction is _____. (Round off to the Nearest Integer).

(Given atomic mass : C : 12.0 u, H : 1.0 u, O : 16.0 u, N : 14.0 u)

Given --
Answer :

Question Type : SA

Question ID : 8643513390

Status : Not Answered

Q.6

The reaction of white phosphorus on boiling with alkali in inert atmosphere resulted in the formation of product 'A'. The reaction of 1 mol of 'A' with excess of AgNO_3 in aqueous medium gives _____ mol(s) of Ag. (Round off to the Nearest Integer).

Given 3
Answer :

Question Type : SA

Question ID : 8643513389

Status : Answered

Q.7

0.01 moles of a weak acid HA ($K_a = 2.0 \times 10^{-6}$) is dissolved in 1.0 L of 0.1 M HCl solution. The degree of dissociation of HA is _____ $\times 10^{-5}$ (Round off to the Nearest Integer). [Neglect volume change on adding HA. Assume degree of dissociation $\ll 1$]

Given --
Answer :

Question Type : SA

Question ID : 8643513386

Status : Not Answered

Q.8 The mole fraction of a solute in a 100 molal aqueous solution is _____ $\times 10^{-2}$.
(Round off to the Nearest Integer).
[Given : Atomic masses : H : 1.0 u, O : 16.0 u]

Given --
Answer :

Question Type : SA
Question ID : 8643513381
Status : Not Answered

Q.9 A certain orbital has $n=4$ and $m_l = -3$. The number of radial nodes in this orbital is _____ . (Round off to the Nearest Integer).

Given --
Answer :

Question Type : SA
Question ID : 8643513383
Status : Not Answered

Q.10 The standard enthalpies of formation of Al_2O_3 and CaO are $-1675 \text{ kJ mol}^{-1}$ and -635 kJ mol^{-1} respectively.
For the reaction
 $3\text{CaO} + 2\text{Al} \rightarrow 3\text{Ca} + \text{Al}_2\text{O}_3$ the standard reaction enthalpy $\Delta_r H^\circ =$ _____ kJ.
(Round off to the Nearest Integer).

Given **230**
Answer :

Question Type : SA
Question ID : 8643513384
Status : Answered

Section : Mathematics Section A

Q.1 The equation of the plane which contains the y -axis and passes through the point (1, 2, 3) is :

- Options**
1. $3x + z = 6$
 2. $x + 3z = 10$
 3. $3x - z = 0$
 4. $x + 3z = 0$

Question Type : **MCQ**

Question ID : **8643513406**

Option 1 ID : **86435110231**

Option 2 ID : **86435110232**

Option 3 ID : **86435110234**

Option 4 ID : **86435110233**

Status : **Not Answered**

Chosen Option : --

Q.2 If $\cot^{-1}(\alpha) = \cot^{-1}2 + \cot^{-1}8 + \cot^{-1}18 + \cot^{-1}32 + \dots$ upto 100 terms, then α is :

- Options**
1. 1.01
 2. 1.02
 3. 1.00
 4. 1.03

Question Type : **MCQ**

Question ID : **8643513398**

Option 1 ID : **86435110200**

Option 2 ID : **86435110201**

Option 3 ID : **86435110199**

Option 4 ID : **86435110202**

Status : **Marked For Review**

Chosen Option : **3**

Q.3 Two dices are rolled. If both dices have six faces numbered 1, 2, 3, 5, 7 and 11, then the probability that the sum of the numbers on the top faces is less than or equal to 8 is :

Options

1. $\frac{5}{12}$

2. $\frac{17}{36}$

3. $\frac{4}{9}$

4. $\frac{1}{2}$



Question Type : **MCQ**

Question ID : **8643513409**

Option 1 ID : **86435110243**

Option 2 ID : **86435110245**

Option 3 ID : **86435110244**

Option 4 ID : **86435110246**

Status : **Answered**

Chosen Option : **2**

Q.4

The value of $\lim_{x \rightarrow 0^+} \frac{\cos^{-1}(x - [x]^2) \cdot \sin^{-1}(x - [x]^2)}{x - x^3}$, where $[x]$ denotes the greatest

integer $\leq x$ is :

- Options
1. 0
 2. $\frac{\pi}{2}$
 3. π
 4. $\frac{\pi}{4}$

Question Type : **MCQ**

Question ID : **8643513400**

Option 1 ID : **86435110208**

Option 2 ID : **86435110209**

Option 3 ID : **86435110210**

Option 4 ID : **86435110207**

Status : **Answered**

Chosen Option : **2**



shiksha

Q.5 Choose the incorrect statement about the two circles whose equations are given below :

$$x^2 + y^2 - 10x - 10y + 41 = 0 \text{ and}$$

$$x^2 + y^2 - 16x - 10y + 80 = 0$$

- Options
1. Both circles pass through the centre of each other.
 2. Both circles' centres lie inside region of one another.
 3. Circles have two intersection points.
 4. Distance between two centres is the average of radii of both the circles.

Question Type : **MCQ**

Question ID : **8643513405**

Option 1 ID : **86435110228**

Option 2 ID : **86435110229**

Option 3 ID : **86435110227**

Option 4 ID : **86435110230**

Status : **Answered**

Chosen Option : **2**



shiksha

Q.6

The sum of possible values of x for $\tan^{-1}(x+1) + \cot^{-1}\left(\frac{1}{x-1}\right) = \tan^{-1}\left(\frac{8}{31}\right)$ is :

Options

1. $-\frac{33}{4}$
2. $-\frac{31}{4}$
3. $-\frac{30}{4}$
4. $-\frac{32}{4}$

Question Type : **MCQ**Question ID : **8643513410**Option 1 ID : **86435110247**Option 2 ID : **86435110249**Option 3 ID : **86435110250**Option 4 ID : **86435110248**Status : **Answered**Chosen Option : **2**

Q.7 If the Boolean expression $(p \Rightarrow q) \Leftrightarrow (q * (\sim p))$ is a tautology, then the Boolean expression $p * (\sim q)$ is equivalent to :

- Options**
1. $\sim q \Rightarrow p$
 2. $q \Rightarrow p$
 3. $p \Rightarrow q$
 4. $p \Rightarrow \sim q$

Question Type : **MCQ**

Question ID : **8643513407**

Option 1 ID : **86435110238**

Option 2 ID : **86435110237**

Option 3 ID : **86435110235**

Option 4 ID : **86435110236**

Status : **Not Answered**

Chosen Option : --



shiksha

Q.8

The value of $4 + \frac{1}{5 + \frac{1}{4 + \frac{1}{5 + \frac{1}{4 + \dots \infty}}}}$ is :

Options

1. $2 + \frac{4}{\sqrt{5}}\sqrt{30}$
2. $2 + \frac{2}{5}\sqrt{30}$
3. $5 + \frac{2}{5}\sqrt{30}$
4. $4 + \frac{4}{\sqrt{5}}\sqrt{30}$

Question Type : MCQ

Question ID : 8643513397

Option 1 ID : 86435110196

Option 2 ID : 86435110195

Option 3 ID : 86435110197

Option 4 ID : 86435110198

Status : Answered

Chosen Option : 2

Q.9 If the fourth term in the expansion of $(x + x^{\log_2 x})^7$ is 4480, then the value of x where $x \in \mathbf{N}$ is equal to :

- Options**
1. 3
 2. 4
 3. 2
 4. 1

Question Type : **MCQ**

Question ID : **8643513396**

Option 1 ID : **86435110193**

Option 2 ID : **86435110194**

Option 3 ID : **86435110192**

Option 4 ID : **86435110191**

Status : **Answered**

Chosen Option : **3**



shiksha

Q.10 Let $\vec{a} = 2\hat{i} - 3\hat{j} + 4\hat{k}$ and $\vec{b} = 7\hat{i} + \hat{j} - 6\hat{k}$.

If $\vec{r} \times \vec{a} = \vec{r} \times \vec{b}$, $\vec{r} \cdot (\hat{i} + 2\hat{j} + \hat{k}) = -3$, then $\vec{r} \cdot (2\hat{i} - 3\hat{j} + \hat{k})$ is equal to :

- Options**
1. 8
 2. 10
 3. 12
 4. 13

Question Type : **MCQ**

Question ID : **8643513408**

Option 1 ID : **86435110239**

Option 2 ID : **86435110240**

Option 3 ID : **86435110241**

Option 4 ID : **86435110242**

Status : **Not Answered**

Chosen Option : --



shiksha

Q.11 The line $2x - y + 1 = 0$ is a tangent to the circle at the point $(2, 5)$ and the centre of the circle lies on $x - 2y = 4$. Then, the radius of the circle is :

Options

1. $5\sqrt{3}$
2. $3\sqrt{5}$
3. $5\sqrt{4}$
4. $4\sqrt{5}$

Question Type : **MCQ**

Question ID : **8643513404**

Option 1 ID : **86435110223**

Option 2 ID : **86435110226**

Option 3 ID : **86435110224**

Option 4 ID : **86435110225**

Status : **Answered**

Chosen Option : **2**



shiksha

Q.12 Which of the following is true for $y(x)$ that satisfies the differential equation

$$\frac{dy}{dx} = xy - 1 + x - y; y(0) = 0 :$$

Options

1. $y(1) = e^{\frac{1}{2}} - e^{-\frac{1}{2}}$

2. $y(1) = e^{\frac{1}{2}} - 1$

3. $y(1) = 1$

4. $y(1) = e^{-\frac{1}{2}} - 1$

Question Type : **MCQ**

Question ID : **8643513402**

Option 1 ID : **86435110217**

Option 2 ID : **86435110216**

Option 3 ID : **86435110218**

Option 4 ID : **86435110215**

Status : **Answered**

Chosen Option : **4**



Q.13 Team 'A' consists of 7 boys and n girls and Team 'B' has 4 boys and 6 girls. If a total of 52 single matches can be arranged between these two teams when a boy plays against a boy and a girl plays against a girl, then n is equal to :

- Options**
1. 6
 2. 5
 3. 4
 4. 2

Question Type : **MCQ**

Question ID : **8643513395**

Option 1 ID : **86435110190**

Option 2 ID : **86435110189**

Option 3 ID : **86435110188**

Option 4 ID : **86435110187**

Status : **Answered**

Chosen Option : **3**



shiksha

Q.14 The inverse of $y = 5^{\log x}$ is :

Options

1. $x = y^{\frac{1}{\log 5}}$

2. $x = 5^{\frac{1}{\log y}}$

3. $x = y^{\log 5}$

4. $x = 5^{\log y}$

Question Type : **MCQ**

Question ID : **8643513399**

Option 1 ID : **86435110204**

Option 2 ID : **86435110203**

Option 3 ID : **86435110206**

Option 4 ID : **86435110205**

Status : **Not Answered**

Chosen Option : --



shiksha

Q.15 The area of the triangle with vertices $A(z)$, $B(iz)$ and $C(z + iz)$ is :

Options

1. $\frac{1}{2} |z|^2$

2. $\frac{1}{2}$

3. 1

4. $\frac{1}{2} |z + iz|^2$



shiksha

Question Type : **MCQ**

Question ID : **8643513392**

Option 1 ID : **86435110176**

Option 2 ID : **86435110177**

Option 3 ID : **86435110178**

Option 4 ID : **86435110175**

Status : **Answered**

Chosen Option : **1**

Q.16 Which of the following statements is incorrect for the function $g(\alpha)$ for $\alpha \in \mathbf{R}$ such that

$$g(\alpha) = \int_{\frac{\pi}{6}}^{\frac{3\pi}{4}} \frac{\sin^\alpha x}{\cos^\alpha x + \sin^\alpha x} dx$$

Options

1. $g(\alpha)$ has an inflection point at $\alpha = -\frac{1}{2}$
2. $g(\alpha)$ is a strictly increasing function
3. $g(\alpha)$ is a strictly decreasing function
4. $g(\alpha)$ is an even function

Question Type : **MCQ**

Question ID : **8643513401**

Option 1 ID : **86435110213**

Option 2 ID : **86435110211**

Option 3 ID : **86435110212**

Option 4 ID : **86435110214**

Status : **Marked For Review**

Chosen Option : **4**



shiksha

Q.17

If $A = \begin{pmatrix} 0 & \sin\alpha \\ \sin\alpha & 0 \end{pmatrix}$ and $\det\left(A^2 - \frac{1}{2}I\right) = 0$, then a possible value of α is :

Options

1. $\frac{\pi}{3}$
2. $\frac{\pi}{6}$
3. $\frac{\pi}{2}$
4. $\frac{\pi}{4}$

Question Type : **MCQ**Question ID : **8643513393**Option 1 ID : **86435110180**Option 2 ID : **86435110181**Option 3 ID : **86435110182**Option 4 ID : **86435110179**Status : **Answered**Chosen Option : **4**

shiksha

Q.18 In a triangle PQR, the co-ordinates of the points P and Q are $(-2, 4)$ and $(4, -2)$ respectively. If the equation of the perpendicular bisector of PR is $2x - y + 2 = 0$, then the centre of the circumcircle of the ΔPQR is :

- Options
1. $(-1, 0)$
 2. $(-2, -2)$
 3. $(0, 2)$
 4. $(1, 4)$

Question Type : **MCQ**

Question ID : **8643513403**

Option 1 ID : **86435110221**

Option 2 ID : **86435110222**

Option 3 ID : **86435110220**

Option 4 ID : **86435110219**

Status : **Answered**

Chosen Option : **2**



shiksha

Q.19 The system of equations $kx + y + z = 1$, $x + ky + z = k$ and $x + y + zk = k^2$ has no solution if k is equal to :

- Options**
1. -1
 2. 0
 3. -2
 4. 1

Question Type : **MCQ**

Question ID : **8643513394**

Option 1 ID : **86435110185**

Option 2 ID : **86435110183**

Option 3 ID : **86435110186**

Option 4 ID : **86435110184**

Status : **Answered**

Chosen Option : **4**



shiksha

Q.20 In a school, there are three types of games to be played. Some of the students play two types of games, but none play all the three games. Which Venn diagrams can justify the above statement ?

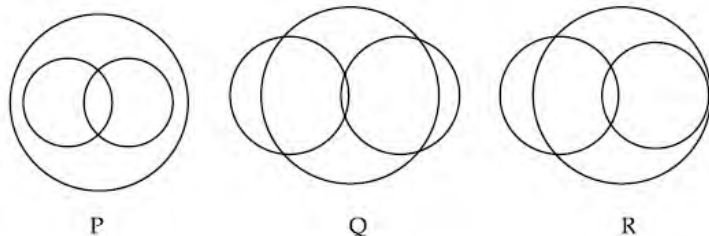

- Options
1. None of these
 2. P and Q
 3. P and R
 4. Q and R

Question Type : **MCQ**

Question ID : **8643513391**

Option 1 ID : **86435110174**

Option 2 ID : **86435110171**

Option 3 ID : **86435110172**

Option 4 ID : **86435110173**

Status : **Not Attempted and
Marked For Review**

Chosen Option : --

Section : **Mathematics Section B**

Q.1 If $[\cdot]$ represents the greatest integer function, then the value of

$$\left| \int_0^{\sqrt{\frac{\pi}{2}}} [x^2] - \cos x \, dx \right| \text{ is } \underline{\hspace{2cm}}.$$

Given 1
Answer :

Question Type : SA
Question ID : 8643513415
Status : Answered

Q.2 If $A = \begin{bmatrix} 2 & 3 \\ 0 & -1 \end{bmatrix}$, then the value of $\det(A^4) + \det(A^{10} - (\text{Adj}(2A))^{10})$ is equal to _____.

Given 0
Answer :

Question Type : SA
Question ID : 8643513412
Status : Answered

Q.3 If the equation of the plane passing through the line of intersection of the planes $2x - 7y + 4z - 3 = 0$, $3x - 5y + 4z + 11 = 0$ and the point $(-2, 1, 3)$ is $ax + by + cz - 7 = 0$, then the value of $2a + b + c - 7$ is _____.

Given 0
Answer :

Question Type : SA
Question ID : 8643513417
Status : Answered

Q.4 If $\vec{a} = \alpha \hat{i} + \beta \hat{j} + 3\hat{k}$,

$$\vec{b} = -\beta \hat{i} - \alpha \hat{j} - \hat{k} \text{ and}$$

$$\vec{c} = \hat{i} - 2\hat{j} - \hat{k}$$

such that $\vec{a} \cdot \vec{b} = 1$ and $\vec{b} \cdot \vec{c} = -3$, then $\frac{1}{3}((\vec{a} \times \vec{b}) \cdot \vec{c})$ is equal to _____.

Given --
Answer :

Question Type : **SA**

Question ID : **8643513420**

Status : **Not Answered**

Q.5

If $f(x) = \sin\left(\cos^{-1}\left(\frac{1-2^{2x}}{1+2^{2x}}\right)\right)$ and its first derivative with respect to x is $-\frac{b}{a} \log_e 2$ when

$x=1$, where a and b are integers, then the minimum value of $|a^2 - b^2|$ is _____.

Given --
Answer :

Question Type : **SA**

Question ID : **8643513419**

Status : **Not Answered**

Q.6 Let there be three independent events E_1 , E_2 and E_3 . The probability that only E_1 occurs is α , only E_2 occurs is β and only E_3 occurs is γ . Let 'p' denote the probability of none of events occurs that satisfies the equations $(\alpha - 2\beta)p = \alpha\beta$ and $(\beta - 3\gamma)p = 2\beta\gamma$. All the given probabilities are assumed to lie in the interval $(0, 1)$.

Then, $\frac{\text{Probability of occurrence of } E_1}{\text{Probability of occurrence of } E_3}$ is equal to _____.

Given --
Answer :

Question Type : SA

Question ID : 8643513418

Status : Not Answered

Q.7 The minimum distance between any two points P_1 and P_2 while considering point P_1 on one circle and point P_2 on the other circle for the given circles' equations

$$x^2 + y^2 - 10x - 10y + 41 = 0$$

$$x^2 + y^2 - 24x - 10y + 160 = 0 \text{ is } \underline{\hspace{2cm}}.$$

Given 0
Answer :

Question Type : SA

Question ID : 8643513416

Status : Answered

Q.8 If $(2021)^{3762}$ is divided by 17, then the remainder is _____.

Given 15
Answer :

Question Type : SA

Question ID : 8643513413

Status : Answered

Q.9 The maximum value of z in the following equation $z = 6xy + y^2$, where $3x + 4y \leq 100$ and $4x + 3y \leq 75$ for $x \geq 0$ and $y \geq 0$ is _____.

Given --
Answer :

Question Type : SA

Question ID : 8643513411

Status : Not Answered

Q.10 If the function $f(x) = \frac{\cos(\sin x) - \cos x}{x^4}$ is continuous at each point in its domain and

$f(0) = \frac{1}{k}$, then k is _____.

Given --
Answer :

Question Type : SA

Question ID : 8643513414

Status : Not Answered

